

751

Trykk nr. 751

Tjenesteskifter utgitt av Norges Statsbaner.
Hovedstyret. M



ILLUSTRERT FORTEGNELSE

OVER

PERSONVOGNER

inklusive post og konduktørvogner

NORMALSPOR

1956-1958



Y:0

OSLO 1. JULI 1956

(Erstatter fortegnelse av 1. januar 1936)

64/1260

625, 23/081)

NS13

DISTRIKTSMERKER

Distrikt	Bane	Distrikts- merke
Oslo	Hovedbanen	Oslo
	Kongsvingerbanen med sidelinjer	
	Solørbanen	
	Østfoldbanen (vestre og østre linje)	
	Gjøvikbanen med sidelinjer	
Drammen	Drammenbanen	Drm
	Vestfoldbanen med sidelinjer	
	Randsfjordbanen med sidelinjer	
	Numedalsbanen	
	Bratsbergbanen	
	Porsgrunn-Brevikbanen	
Sörlandsbanen (Nordagutu-Lunde)		
Hamar	Eidsvoll-Dombåsbanen	Hmr
	Raumabanen	
	Rörosbanen (Hamar-Tynset)	
Trondheim	Rörosbanen (Tynset-Stören)	Thm
	Dovrebanen	
	Meråkerbanen	
	Nordlandsbanen (med linjen Grong-Namsos)	
Stavanger	Sörlandsbanen (Sira-Stavanger) med sidelinjer	Stv
Bergen	Bergensbanen (Hönefoss-Bergen)	Brg
	Flåmsbana	
	Hardangerbana	
Kristiansand	Sörlandsbanen (Lunde-Sira) med sidelinjer	Krs
	Setesdalsbanen	
Narvik	Ofotbanen	Nrv

I fortegnelsen er distriktsmerke angitt med forbokstaver. (F.eks. Oslo=O, Drm=D o.s.v.)

Alle vogner har eiendomsmerke "NSB Norge"



LITRABETEGNELSER

Bokstavmerke	A	=	1ste	klasses	vogn.
"	AB	=	1ste	og 2nen	klasses vogn.
"	ABF	=	1ste	og 2nen	" " og konduktörvogn.
"	ABZ	=	1ste	og 2nen	" " og sykevogn.
"	AF	=	1ste	klasses	vogn og konduktörvogn.
"	B	=	2nen	klasses	vogn.
"	BD	=	2nen	" "	og postvogn.
"	BDF	=	2nen	" "	og post- og konduktörvogn.
"	BE	=	2nen	" "	og spisevogn.
"	BF	=	2nen	" "	og konduktörvogn.
"	BFZ	=	2nen	" "	og konduktör- og sykevogn.
"	BZ	=	2nen	" "	og sykevogn.
"	D	=	Post	vogn.	
"	DF	=	Post-	og konduktör	vogn.
"	DFZ	=	Post-	og konduktör-	og sykevogn.
"	E	=	Spise	vogn.	
"	F	=	Konduktör	vogn.	
"	Fd	=	Konduktör	vogn med dampkjel	for togoppvarming.
"	FZ	=	Konduktör-	og sykevogn.	
"	Z	=	Syke	vogn.	
"	Zu	=	Sanitets	vogn.	

o etter bokstavmerket betegner at vognen er boggivogn.

Videre betegner:

WL foran bokstavmerket og indeks	1	-	Sovevogn.	
	"	2	- Sidegangsvogn	} fjerntogssitte- vogner.
	"	3	- Midtgangsvogn	
	"	4	- Lokaltogsvogn.	

På vogner med postavdeling angir tall tilslutt i litrabetegnelsen og adskilt fra denne med en - , postrommets størrelse i m².

Bokstav a, b, c osv. etter indeks er en gruppebokstav for gruppering av vogner som i trafikkmessig henseende regnes som likeverdige.

VOGNFABRIKANTER

De forskjellige vognfabrikanter er angitt i
fortegnelsen med følgende forkortelser:

AaB = Aadals Brug

Atl = Atlas mek. Verksted

Edf = A/S Eidsfoss Verk

Kok = Kockum, Malmö

KvB = Kværner Brug A/S

NHJ = Hovedbanens verksted

Scd = Scandia, Randers

SJv = Svenska Järnverkstederna, Linköping

Skb = Skabo Jernbanevognfabrik A/S

SMv = Svenska Maskinverken, Södertelje

Str = A/S Strömmens Værksted

SWf = Sachische Wagonfabrikk

VOGNUTSTYR

Tallene i rubrikken "Vognutstyr" betegner:

- 1H. Trykkluftbremse (Hildebrand-Knorrbremse).
- 1KK. " (Kunze-Knorrbremse).
- 1W. " (Westinghousebremse).
- 1Hs. " for ekspresstog.
- 3. Skruebremse.
- 5. Dampoppvarming.
- 6. Ledning for dampoppvarming.
- 7. Schweizerapparat.
- 8. Ovn.
- 10. Elektrisk lys (batteri).
- 11. " " (generator og batteri).
- 12. " " (likeretter og batteri).
- 13. Petroleumslampe.
- 15. Rörledning for trykkluftbremse.
- 24. Frie lenkaksler.
- 28. Overgangsbelg.
- 35. Dansk varmekobling.
- 39a. Elektrisk oppvarming (varmeovner).
- 39b. " " (varmluft).
- 39c. " " (luftkondisjonering).
- 40. Ledning for elektrisk oppvarming.
- 41. Varmtvannsoppvarming.
- 44. Elektrisk lys (vekselströmstransformator).

VOGNENE ORDNET I NUMMERORDEN

Nr.	Litra	Type	Nr.	Litra	Type	Nr.	Litra	Type	Nr.	Litra	Type
9	BFo3b	3	96	BFo3a	1	141	Bo4a	1	185	BFo2c	2
10	"	"	97	BFo2c	2	142	"	"	186	Bo3a	1
16	Zo	1	98	"	"	143	"	"	187	"	"
31	ABZo2b	1	100	Ao	2	144	"	"	188	BFo2c	2
34	ABo3a	1	102	WLBolb	1	145	BF2a	1	194	Bo4a	1
35	"	"	103	WLAola	1	146	Bo4a	1	195	"	"
36	"	"	104	"	"	147	"	"	196	"	"
37	"	"	105	"	"	148	"	"	197	"	"
39	Bo4c	1	106	WLABolb	1	149	"	"	198	"	"
44	"	"	107	BFo2a	5	150	"	"	199	WLBola	1
47	"	"	110	BFo2a	6	151	BF2a	1	200	"	"
66	Bo2c	3	113	WLBolb	1	152	WLBola	1	201	WLAola	1
67	BFo3a	2	114	WLABola	1	153	Bo2b	2	202	"	"
68	"	"	115	"	"	154	"	"	204	BFo2a	5
69	"	"	116	"	"	155	WLBola	1	205	Zuo	3
70	BDFo3-7	2	117	"	"	156	Bo2b	2	206	Ao	1
71	BDFo4-7	1	118	Ao	3	157	"	"	207	WLABolb	1
72	"	"	119	Eo	3	158	WLBola	1	208	"	"
73	BFo4a	1	120	BFo2c	2	159	"	"	209	Ao2b	1
77	Bo4b	2	121	"	"	160	Bo3c	1	210	WLAola	1
78	Bo4b	4	122	BFo2c	3	161	Bo4d	1	212	BFo2a	2
79	"	"	123	"	"	164	Bo2a	1	213	BFo2c	3
80	Bo3b	1	125	Bo2c	2	166	Zuo	3	214	"	"
81	"	"	126	Zo	2	167	Bo2a	1	215	"	"
82	"	"	127	Bo4a	1	168	"	"	216	"	"
83	"	"	128	"	"	171	Bo2b	2	217	Bo3a	1
84	Bo3b	2	129	"	"	172	"	"	219	"	"
85	"	"	130	"	"	173	"	"	220	Bo3a	2
86	"	"	131	Bo2c	1	174	"	"	221	"	"
87	Bo3b	3	132	Zuo	2	175	Bo3a	1	222	"	"
88	"	"	133	ABZo2a	1	176	"	"	223	"	"
89	"	"	135	ABZo2a	2	177	"	"	224	Bo2b	3
91	DFo-21	1	136	ABo2b	3	179	"	"	225	"	"
92	DFo-18	1	137	"	"	180	"	"	226	"	"
93	BFZo2a	1	138	"	"	182	BDo2-16	1	233	Bo4d	5
94	BFo2c	1	139	"	"	183	BFo2b	6	235	BF3b	1
95	BFo3b	4	140	Bo4a	1	184	BFo2c	2	236	"	"

VOGNE NE ORDNET I NUMMERORDEN

Nr.	Litra	Type	Nr.	Litra	Type	Nr.	Litra	Type	Nr.	Litra	Type
237	BF3b	1	322	Bo4b	1	443	Zu	1	541	Bo2b	1
238	BDFo3-16	1	323	"	"	450	Bo3d	1	542	ABo2b	2
239	"	"	324	"	"	451	"	"	543	"	"
240	BF3b	1	325	BFo3b	1	452	"	"	544	"	"
241	BFo2a	2	326	BDFo3-7	1	453	"	"	545	BFo2b	4
242	AFo2a	1	327	Bo2a	1	473	ABo2b	2	546	BF3b	2
245	BFo2c	5	328	"	"	474	Bo4d	1	547	"	"
246	"	"	329	"	"	475	"	"	548	"	"
247	Ao2b	1	330	"	"	476	Bo2b	1	549	"	"
248	Ao2c	1	331	"	"	477	"	"	550	ABo3b	3
280	Bo2b	2	332	"	"	478	Bo4d	1	551	"	"
281	"	"	333	"	"	479	BFo3b	2	552	"	"
282	"	"	334	"	"	490	BFo4a	2	553	Bo3c	1
284	"	"	335	"	"	499	Eo	3	554	"	"
285	"	"	336	"	"	500	"	"	555	"	"
286	Bo3c	1	337	"	"	501	Ao2a	2	556	"	"
287	"	"	338	BDo2-11	2	502	"	"	557	"	"
288	"	"	339	BDo2-7	1	503	Bo2b	6	558	"	"
289	"	"	340	"	"	504	Ao2b	1	559	"	"
290	Bo2b	2	341	Bo2b	2	505	Bo2b	6	560	"	"
291	"	"	342	"	"	506	"	"	561	"	"
292	"	"	343	"	"	507	"	"	562	"	"
293	"	"	344	"	"	508	"	"	563	Bo2b	2
294	Bo3c	2	345	"	"	509	Bo2a	2	564	"	"
295	BDFo3-11	1	346	"	"	510	"	"	565	"	"
296	BFo2c	2	347	"	"	511	"	"	566	"	"
304	ABo2a	2	348	ABo2b	3	512	DFZo-16	1	567	"	"
305	Bo3c	2	349	"	"	513	"	"	568	"	"
306	ABo3b	1	350	"	"	514	BDFo2-7	1	569	"	"
307	ABo2a	2	351	"	"	515	"	"	570	"	"
308	ABo3b	2	352	"	"	517	DFo-22	3	571	"	"
309	"	"	428	Zuo	3	518	BFo2b	4	572	"	"
310	ABo3b	3	432	DFo-22	4	519	"	"	573	ABo2b	3
311	"	"	433	DFo-32	2	520	Zu	1	574	"	"
314	Zuo	1	434	DFo-16	2	527	"	"	575	BFo2b	6
318	Bo4d	4	435	DFo-32	3	539	Bo2b	1	576	"	"
320	Bo4b	1	436	DFo-16	2	540	"	"	577	"	"

VOGNENE ORDNET I NUMMERORDEN

Nr.	Litra	Type	Nr.	Litra	Type	Nr.	Litra	Type	Nr.	Litra	Type
578	BFo2b	6	643	Bo3a	1	697	BF3a	2	780	BFo2b	6
579	WLBola	1	644	"	"	701	WLAola	1	781	"	"
580	Bo2b	2	645	Bo3c	2	702	Ao	4	782	Bo2b	2
581	Ao2d	1	646	Bo3a	1	703	Eo	2	783	"	"
586	Bo4c	1	647	BFo2c	2	704	Ao	4	784	BFo2c	6
587	"	"	648	"	"	705	WLABola	1	785	BFo2b	6
601	"	"	649	BFo2b	6	707	Bo3c	2	786	WLBola	1
602	WLAola	1	650	"	"	724	BFo2c	5	787	Do-39	1
603	Bo3a	1	651	Bo3a	1	732	BFo2a	1	788	Bo3a	1
604	BFo2b	8	652	"	"	736	ABo2b	1	789	"	"
605	Bo4c	1	653	WLABola	1	737	Bo2b	5	790	Bo3c	1
606	"	"	654	Bo2b	3	739	ABo3b	2	791	"	"
607	"	"	655	"	"	740	ABo2b	3	792	BFo2b	6
608	"	"	656	"	"	741	ABo3b	3	793	"	"
609	"	"	657	"	"	742	Bo3c	1	794	"	"
610	"	"	658	Bo3a	2	743	"	"	795	"	"
620	BDFo2-11	3	659	"	"	744	Bo2b	2	796	"	"
621	"	"	660	Bo2b	3	745	"	"	797	"	"
622	DFo-32	2	661	"	"	746	Bo3c	1	799	ABFo2a	1
623	Bo2b	2	662	"	"	747	Bo3c	2	802	BDFo2-11	1
624	BFo2b	8	663	Bo3a	2	748	Bo3c	1	804	DFo-29	1
625	"	"	664	"	"	749	"	"	805	BFo2a	3
626	"	"	665	Bo3c	2	762	Bo2c	1	806	BFo2c	1
627	BFo2a	4	666	"	"	763	BFo2c	7	807	"	"
628	WLABola	1	679	BF2b	1	765	"	"	808	DFo-29	1
629	"	"	681	Bo3b	5	768	Bo2b	4	811	Ao2c	1
630	"	"	682	"	"	769	Bo2b	1	812	BFo2b	4
631	Bo3a	1	683	Bo3b	4	770	Bo2b	2	813	Bo3c	1
632	BFo2c	6	684	"	"	771	"	"	814	Bo3a	1
633	Bo3a	1	685	BF2a	2	772	BEo3a	1	815	BFo2b	5
634	"	"	686	"	"	773	Bo3c	1	835	Bo2a	1
635	"	"	687	"	"	774	"	"	836	Zuo	3
636	"	"	689	"	"	775	BDFo2-11	5	837	BFo2b	2
637	Bo2b	2	690	Ao3a	1	776	BFo2b	6	841	Bo2a	1
638	"	"	691	BF2b	1	777	Zuo	3	842	"	"
639	"	"	693	"	"	778	BFo2b	2	843	"	"
640	"	"	695	"	"	779	BFo2b	4	844	ABZo2b	2

VOGNENE ORDNET I NUMMERORDEN

Nr.	Litra	Type	Nr.	Litra	Type	Nr.	Litra	Type	Nr.	Litra	Type
845	BFo2c	4	910	Bo2a	1	952	Ao2a	1	990	Ao3a	1
849	Bo2a	1	911	DFo-22	2	953	"	"	991	WLAola	1
850	"	"	912	"	"	954	Zuo	3	992	"	"
851	BFo2b	2	913	BDo2-11	1	955	ABo2a	1	995	"	"
852	BFo2c	2	916	BDFo2-4	1	956	Bo2b	6	996	WLBola	1
875	DFo-22	5	917	BDFo2-11	2	957	Bo2a	2	1001	BF3a	1
876	Bo2b	2	918	Bo2b	6	958	"	"	1002	"	"
877	"	"	919	ABo3b	1	959	"	"	1003	"	"
878	"	"	920	Bo3c	3	961	"	"	1007	F	5
879	BFo2c	2	921	ABo2a	1	962	"	"	1008	F	3
880	Bo2b	2	923	Bo2b	6	963	BDFo2-7	1	1009	F	4
881	BDFo2-11	7	924	ABZo2a	2	964	"	"	1010	F	5
882	BFo2c	2	925	ABo2a	2	965	BFo2b	1	1023	Fd	4
883	ABo2b	3	926	"	"	966	Bo4b	3	1024	"	"
884	Bo2b	2	927	"	"	967	"	"	1025	Fd	1
885	"	"	928	Bo2c	5	968	"	"	1026	"	"
886	Bo3a	2	929	"	"	969	"	"	1027	"	"
887	"	"	930	"	"	970	"	"	2001	F	2
888	BFo2c	2	931	Bo2a	2	971	BFo3b	6	2007	F	3
889	Bo3c	1	932	"	"	972	"	"	2010	F	2
890	WLBola	1	934	"	"	973	Bo3c	3	2011	F	6
891	"	"	935	"	"	974	"	"	2012	"	"
892	Bo3c	1	937	DFZo-16	2	975	"	"	2013	F	4
893	"	"	938	"	"	976	BFo2b	4	2015	F	7
894	"	"	939	"	"	977	"	"	2016	"	"
895	"	"	940	BFo2b	3	978	Eo	5	2017	"	"
896	"	"	941	"	"	979	Eo	1	2018	"	"
897	"	"	942	"	"	980	Eo	5	2019	"	"
898	ABo3b	1	943	Bo2a	2	981	Bo2b	1	2020	"	"
899	"	"	944	Eo	1	982	"	"	2021	"	"
900	Ao3a	1	945	"	"	983	WLBola	1	2022	F	10
901	Bo2c	4	946	Ao3a	1	984	"	"	2023	F	15
902	Bo2b	5	947	"	"	985	WLAola	1	2024	F	10
903	"	"	948	ABo3b	1	986	"	"	2025	F	11
906	BFo2c	5	949	"	"	987	"	"	2026	"	"
908	Bo2a	1	950	Ao2c	1	988	"	"	2027	"	"
909	"	"	951	Ao2a	1	989	Ao3a	1	2028	"	"

VOGNE NE ORDNET I NUMMERORDEN

Nr.	Litra	Type	Nr.	Litra	Type	Nr.	Litra	Type	Nr.	Litra	Type
2029	F	15	5009	F	8	6020	F	11	14014	Fo	3
2030	F	11	5010	F	15	6021	"	"	14015	"	"
3007	F	6	5012	F	10	6022	"	"	14952	F	16
3008	"	"	5013	"	"	6023	F	12	15008	F	8
3009	F	9	5014	"	"	6024	"	"	15009	"	"
3010	"	"	5015	"	"	6025	F	10	15010	F	5
3011	"	"	5016	"	"	7001	F	2	15011	F	8
3012	"	"	5017	FZo	2	7005	F	8	15012	"	"
3017	F	7	5018	"	"	7006	"	"	15013	"	"
3021	F	2	5019	"	"	8002	F	2	15014	"	"
3029	"	"	5020	F	11	8003	"	"	15015	"	"
3030	F	10	5021	"	"	8005	"	"	15016	"	"
3031	"	"	5022	"	"	8487	F	16	15017	F	10
3032	"	"	5023	"	"	9001	BF	2	15019	Fo	4
3033	F	11	5024	"	"	9003	F	6	17451	F	11
3034	"	"	5634	F	10	9004	"	"	17952	Fd	5
3035	"	"	5635	"	"	9006	"	"	17953	F	10
3036	"	"	5678	Fo	5	9007	F	8	17954	"	"
3037	"	"	5679	Fo	1	12101	F	6	17955	"	"
3038	"	"	5680	FZo	2	12102	"	"	17956	Fo	5
3039	"	"	5681	"	"	12103	"	"	18001	BFo2b	5
3040	Fd	1	6001	F	6	12104	"	"	18002	ABo2b	3
3041	"	"	6002	"	"	13021	Fd	3	18003	WLBolb	1
3042	"	"	6003	"	"	13022	F	13	18004	ABo3b	3
3043	"	"	6005	"	"	14001	F	6	18005	WLBola	1
3044	Fo	4	6007	"	"	14002	"	"	18006	Eo	2
3045	"	"	6008	F	8	14003	F	5	18007	Bo3c	1
3046	"	"	6010	F	9	14004	Fd	2	18008	"	"
3047	"	"	6011	"	"	14005	F	8	18009	DFo-16	1
3552	BF	1	6012	"	"	14006	"	"	18010	DFo-32	1
3554	F	6	6013	"	"	14007	"	"	18011	Eo	2
3555	"	"	6014	F	10	14008	"	"	18012	Bo2b	2
3556	"	"	6015	"	"	14009	"	"	18013	"	"
3557	"	"	6016	"	"	14010	F	10	18014	"	"
3558	"	"	6017	F	11	14011	"	"	18015	BFo2c	2
3560	F	4	6018	"	"	14012	"	"	18016	BDFo2-7	3
5008	F	2	6019	"	"	14013	Fo	3	18017	"	"

VOGNENE ORDNET I NUMMERORDEN

Nr.	Litra	Type	Nr.	Litra	Type	Nr.	Litra	Type	Nr.	Litra	Type
18018	ABo2b	3	18059	Bo3c	1	18110	Bo3a	1	18170	BFo3b	5
18019	BFo2b	6	18060	"	"	18113	BDF3-4	1	18171	Bo3d	2
18020	"	"	18061	"	"	18114	WLBold	1	18172	"	"
18021	"	"	18062	Bo2b	2	18115	"	"	18173	"	"
18022	"	"	18063	WLBola	1	18116	WLBola	1	19001	Bo2d	1
18023	"	"	18064	Ao2b	1	18117	"	"	19002	"	"
18024	ABo2b	3	18065	ABo2b	3	18118	Bo4d	2	19003	"	"
18025	"	"	18066	"	"	18119	"	"	19004	"	"
18026	Bo2b	2	18074	WLABolb	1	18120	"	"	19005	"	"
18027	"	"	18075	"	"	18121	"	"	19006	"	"
18028	"	"	18076	WLAola	1	18122	"	"	19007	"	"
18029	BDFo2-7	2	18077	Bo3a	1	18123	"	"	19008	"	"
18030	Bo3a	1	18078	"	"	18124	"	"	19009	"	"
18031	"	"	18079	BFo2b	6	18125	WLABola	1	19010	"	"
18033	BDFo2-11	6	18080	BFo2a	4	18126	"	"	19011	"	"
18034	BDFo2-11	3	18081	BDFo2-7	2	18127	ABo3b	3	19012	"	"
18035	Ao2b	1	18082	"	"	18128	"	"	19013	"	"
18036	Bo3c	2	18083	"	"	18129	Bo3a	1	19014	"	"
18037	Bo2b	2	18085	BDFo2-11	3	18130	BFo2b	7	19015	"	"
18038	BEo3a	1	18086	"	"	18131	Bo2b	3	19016	"	"
18039	"	"	18089	DFo-32	2	18132	"	"	19017	"	"
18040	Bo3a	1	18090	BDFo2-11	3	18133	"	"	19018	"	"
18041	"	"	18091	BDFo2-11	4	18134	"	"	19019	"	"
18042	Bo2b	2	18092	BDFo2-7	2	18135	"	"	19020	"	"
18043	BFo2b	6	18097	WLAola	1	18136	Bo3a	2	19021	"	"
18044	"	"	18098	"	"	18137	"	"	19022	"	"
18047	WLAola	1	18099	Bo2b	2	18138	"	"	19023	"	"
18048	WLBolb	1	18100	BFo2b	6	18139	BEo3a	1	19024	"	"
18049	Bo3c	2	18101	WLAola	1	18140	"	"	19025	"	"
18050	WLBolb	1	18102	WLBola	1	18143	Bo2b	3	19026	"	"
18052	BFo2b	6	18103	"	"	18144	"	"	19027	"	"
18053	Bo3a	1	18104	BFo2b	6	18145	"	"	19028	"	"
18054	"	"	18105	"	"	18146	Bo3c	2	19029	"	"
18055	ABo3b	3	18106	Do-39	2	18147	"	"	19030	"	"
18056	WLBola	1	18107	"	"	18148	"	"	19031	Bo3f	1
18057	Bo2b	2	18108	BDFo4-7	2	18149	"	"	19032	"	"
18058	"	"	18109	BDFo2-11	3	18169	BFo3b	5	19033	"	"

VOGNENE ORDNET I NUMMERORDEN

Nr.	Litra	Type	Nr.	Litra	Type	Nr.	Litra	Type	Nr.	Litra	Type	
19034	Bo3f	1	19907	Se tilleggs- blad til BF3 type 1		20061	Fdo	1	21030	WLBold	2	
19035	"	"	19908				20062	Fo	2	21031	"	"
19036	"	"	19909				20063	"	"	21032	WLABold	2
19037	"	"	19911				20064	Fo	3	21033	"	"
19038	"	"	19912				20065	"	"	21034	"	"
19039	"	"	19913		B3	1	20066	"	"	21251	Eo	4
19040	"	"	19914		"	"	20773	F	11	21252	"	"
19041	"	"	19915		"	"	20774	"	"	21253	"	"
19042	"	"	19916		"	"	21001	WLAolb	1	21254	"	"
19043	"	"	19918		"	"	21002	"	"	21301	DFo-32	4
19044	"	"	19919		"	"	21003	"	"	21302	"	"
19045	"	"	19920		"	"	21004	WLABold	1	21303	"	"
19046	"	"	19921	"	"	21005	"	"	21304	DFo-37	1	
19047	"	"	19922	Bo3g	1	21006	"	"	21305	"	"	
19048	"	"	19923	"	"	21007	WLBolc	1	21306	"	"	
19049	"	"	19924	"	"	21008	"	"	21307	"	"	
19050	"	"	19925	"	"	21009	"	"	21308	DFo-27	1	
19051	"	"	19926	"	"	21010	WLAolb	2	21309	"	"	
19052	"	"	19927	"	"	21011	"	"	21310	"	"	
19053	"	"	19928	"	"	21012	"	"	21311	"	"	
19054	"	"	19929	"	"	21013	"	"	21312	"	"	
19055	"	"	19930	Bo3g	2	21014	"	"	21313	"	"	
19056	"	"	19951	Fo	6	21015	"	"	21501	BFo2d	1	
19057	"	"	19952	"	"	21016	WLABold	2	21502	"	"	
19058	"	"	19953	Fo	7	21017	"	"	21503	"	"	
19059	"	"	19954	Fdo	2	21018	"	"	21504	BFo2d	2	
19060	"	"	19955	"	"	21019	WLBold	2	21505	"	"	
19061	ABo2c	1	20051	F	10	21020	"	"	21506	"	"	
19062	"	"	20052	"	"	21021	"	"	21507	"	"	
19063	"	"	20053	"	"	21022	"	"	21508	"	"	
19900	BF3	1	20054	F	11	21023	"	"	21509	"	"	
19901	Se tilleggs- blad til BF3 type 1		20055	"	"	21024	"	"	21510	"	"	
19902			20056	"	"	21025	"	"	21511	"	"	
19903			20057	"	"	21026	"	"	21512	"	"	
19904			20058	Fdo	1	21027	"	"	21513	"	"	
19905			20059	"	"	21028	"	"	21514	"	"	
19906			20060	"	"	21029	"	"	23101	F	10	

VOGNENE ORDNET I NUMMERORDEN

Nr.	Litra	Type	Nr.	Litra	Type	Nr.	Litra	Type	Nr.	Litra	Type
23102	F	10									

. VOGNENE ORDNET I NUMMERORDEN

Nr.	Litra	Type	Nr.	Litra	Type	Nr.	Litra	Type	Nr.	Litra	Type
9	BFo3b	3	96	BFo3a	1	141	Bo4a	1	185	BFo2c	2
10	"	"	97	BFo2c	2	142	"	"	186	Bo3a	1
16	Zo	1	98	"	"	143	"	"	187	"	"
31	ABZo2b	1	100	Ao	2	144	"	"	188	BFo2c	2
34	ABo3a	1	102	WLBolb	1	145	BF2a	1	194	Bo4a	1
35	"	"	103	WLAola	1	146	Bo4a	1	195	"	"
36	"	"	104	"	"	147	"	"	196	"	"
37	"	"	105	"	"	148	"	"	197	"	"
39	Bo4c	1	106	WLABolb	1	149	"	"	198	"	"
44	"	"	107	BFo2a	5	150	"	"	199	WLBola	1
47	"	"	110	BFo2a	6	151	BF2a	1	200	"	"
66	Bo2c	3	113	WLBolb	1	152	WLBola	1	201	WLAola	1
67	BFo3a	2	114	WLABola	1	153	Bo2b	2	202	"	"
68	"	"	115	"	"	154	"	"	204	BFo2a	5
69	"	"	116	"	"	155	WLBola	1	205	Zuo	3
70	BDFo3-7	2	117	"	"	156	Bo2b	2	206	Ao	1
71	BDFo4-7	1	118	Ao	3	157	"	"	207	WLABolb	1
72	"	"	119	Eo	3	158	WLBola	1	208	"	"
73	BFo4a	1	120	BFo2c	2	159	"	"	209	Ao2b	1
77	Bo4b	2	121	"	"	160	Bo3c	1	210	WLAola	1
78	Bo4b	4	122	BFo2c	3	161	Bo4d	1	212	BFo2a	2
79	"	"	123	"	"	164	Bo2a	1	213	BFo2c	3
80	Bo3b	1	125	Bo2c	2	166	Zuo	3	214	"	"
81	"	"	126	Zo	2	167	Bo2a	1	215	"	"
82	"	"	127	Bo4a	1	168	"	"	216	"	"
83	"	"	128	"	"	171	Bo2b	2	217	Bo3a	1
84	Bo3b	2	129	"	"	172	"	"	219	"	"
85	"	"	130	"	"	173	"	"	220	Bo3a	2
86	"	"	131	Bo2c	1	174	"	"	221	"	"
87	Bo3b	3	132	Zuo	2	175	Bo3a	1	222	"	"
88	"	"	133	ABZo2a	1	176	"	"	223	"	"
89	"	"	135	ABZo2a	2	177	"	"	224	Bo2b	3
91	DFo-21	1	136	ABo2b	3	179	"	"	225	"	"
92	Fo	8	137	"	"	180	"	"	226	"	"
93	BFZo2a	1	138	"	"	182	BDo2-16	1	233	Bo4d	5
94	BFo2c	1	139	"	"	183	BFo2b	6	235	BF3b	1
95	BFo3b	4	140	Bo4a	1	184	BFo2c	2	236	"	"

VOGNE NE ORDNET I NUMMERORDEN

Nr.	Litra	Type	Nr.	Litra	Type	Nr.	Litra	Type	Nr.	Litra	Type
237	BF3b	1	322	Bo4b	1	443	Zu	1	541	Bo2b	1
238	BDFo3-16	1	323	"	"	450	Bo3d	1	542	ABo2b	2
239	"	"	324	"	"	451	"	"	543	"	"
240	BF3b	1	325	BFo3b	1	452	"	"	544	"	"
241	BFo2a	2	326	BDFo3-7	1	453	"	"	545	BFo2b	4
242	AFo2a	1	327	Bo2a	1	473	ABo2b	2	546	BF3b	2
245	BFo2c	5	328	"	"	474	Bo4d	1	547	"	"
246	"	"	329	"	"	475	"	"	548	"	"
247	Ao2b	1	330	"	"	476	Bo2b	1	549	"	"
248	Ao2c	1	331	"	"	477	"	"	550	ABo3b	3
280	Bo2b	2	332	"	"	478	Bo4d	1	551	"	"
281	"	"	333	"	"	479	BFo3b	2	552	"	"
282	"	"	334	"	"	490	BFo4a	2	553	Bo3c	1
284	"	"	335	"	"	499	Eo	3	554	"	"
285	"	"	336	"	"	500	"	"	555	"	"
286	Bo3c	1	337	"	"	501	Ao2a	2	556	"	"
287	"	"	338	BDo2-11	2	502	"	"	557	"	"
288	"	"	339	BDo2-7	1	503	Bo2b	6	558	"	"
289	"	"	340	"	"	504	Ao2b	1	559	"	"
290	Bo2b	2	341	Bo2b	2	505	Bo2b	6	560	"	"
291	"	"	342	"	"	506	"	"	561	"	"
292	"	"	343	"	"	507	"	"	562	"	"
293	"	"	344	"	"	508	"	"	563	Bo2b	2
294	Bo3c	2	345	"	"	509	Bo2a	2	564	"	"
295	BDFo3-11	1	346	"	"	510	"	"	565	"	"
296	BFo2c	2	347	"	"	511	"	"	566	"	"
304	ABo2a	2	348	ABo2b	3	512	DFZo-16	1	567	"	"
305	Bo3c	2	349	"	"	513	"	"	568	"	"
306	ABo3b	1	350	"	"	514	BDFo2-7	1	569	"	"
307	ABo2a	2	351	"	"	515	"	"	570	"	"
308	ABo3b	2	352	"	"	517	DFo-22	3	571	"	"
309	"	"	428	Zuo	3	518	BFo2b	4	572	"	"
310	ABo3b	3	432	DFo-22	4	519	"	"	573	ABo2b	3
311	"	"	433	DFo-32	2	520	Zu	1	574	"	"
314	Zuo	1	434	DFo-16	2	527	"	"	575	BFo2b	6
318	Bo4d	4	435	DFo-32	3	539	Bo2b	1	576	"	"
320	Bo4b	1	436	DFo-16	2	540	"	"	577	"	"

VOGNE NE ORDNET I NUMMERORDEN

Nr.	Litra	Type	Nr.	Litra	Type	Nr.	Litra	Type	Nr.	Litra	Type
578	BFo2b	6	643	Bo3a	1	697	BF3a	2	780	BFo2b	6
579	WLBola	1	644	"	"	701	WLAola	1	781	"	"
580	Bo2b	2	645	Bo3c	2	702	Ao	4	782	Bo2b	2
581	Ao2d	1	646	Bo3a	1	703	Eo	2	783	"	"
586	Bo4c	1	647	BFo2c	2	704	Ao	4	784	BFo2c	6
587	"	"	648	"	"	705	WLABola	1	785	BFo2b	6
601	"	"	649	BFo2b	6	707	Bo3c	2	786	WLBola	1
602	WLAola	1	650	"	"	724	BFo2c	5	787	Do-39	1
603	Bo3a	1	651	Bo3a	1	732	BFo2a	1	788	Bo3a	1
604	BFo2b	8	652	"	"	736	ABo2b	1	789	"	"
605	Bo4c	1	653	WLABola	1	737	Bo2b	5	790	Bo3c	1
606	"	"	654	Bo2b	3	739	ABo3b	2	791	"	"
607	"	"	655	"	"	740	ABo2b	3	792	BFo2b	6
608	"	"	656	"	"	741	ABo3b	3	793	"	"
609	"	"	657	"	"	742	Bo3c	1	794	"	"
610	"	"	658	Bo3a	2	743	"	"	795	"	"
620	BDFo2-11	3	659	"	"	744	Bo2b	2	796	"	"
621	"	"	660	Bo2b	3	745	"	"	797	BFo2b	7
622	DFo-32	2	661	"	"	746	Bo3c	1	799	BFo2c	3
623	Bo2b	2	662	"	"	747	Bo3c	2	802	BDFo2-11	1
624	BFo2b	8	663	Bo3a	2	748	Bo3c	1	804	DFo-29	1
625	"	"	664	"	"	749	"	"	805	BFo2a	3
626	"	"	665	Bo3c	2	762	Bo2c	1	806	BFo2c	1
627	BFo2a	4	666	"	"	763	BFo2c	7	807	"	"
628	WLABola	1	679	BF2b	1	765	"	"	808	DFo-29	1
629	"	"	681	Bo3b	5	768	Bo2b	4	811	Ao2c	1
630	"	"	682	"	"	769	Bo2b	1	812	BFo2b	4
631	Bo3a	1	683	Bo3b	4	770	Bo2b	2	813	Bo3c	1
632	BFo2c	6	684	"	"	771	"	"	814	Bo3a	1
633	Bo3a	1	685	BF2a	2	772	BEo3a	1	815	BFo2b	5
634	"	"	686	"	"	773	Bo3c	1	835	Bo2a	1
635	"	"	687	"	"	774	"	"	836	Zuo	3
636	"	"	689	"	"	775	BDFo2-11	7	837	BFo2b	2
637	Bo2b	2	690	Ao3a	1	776	BFo2b	6	841	Bo2a	1
638	"	"	691	BF2b	1	777	Zuo	3	842	"	"
639	"	"	693	"	"	778	BFo2b	2	843	"	"
640	"	"	695	"	"	779	BFo2b	4	844	ABZo2b	2

VOGNE NE ORDNET I NUMMERORDEN

Nr.	Litra	Type	Nr.	Litra	Type	Nr.	Litra	Type	Nr.	Litra	Type
845	BFo2c	4	910	Bo2a	1	952	Ao2a	1	990	Ao3a	1
849	Bo2a	1	911	DFo-22	2	953	Bo2c	5	991	WLAola	1
850	"	"	912	"	"	954	Zuo	3	992	"	"
851	BFo2b	2	913	BDo2-11	1	955	Bo2b	6	995	"	"
852	BFo2c	2	916	BDFo2-4	1	956	"	"	996	WLBola	1
875	DFo-22	5	917	BDFo2-11	2	957	Bo2a	2	1001	BF3a	1
876	Bo2b	2	918	Bo2b	6	958	"	"	1002	"	"
877	"	"	919	ABo3b	1	959	"	"	1007	F	5
878	"	"	920	Bo3c	3	961	"	"	1008	F	3
879	BFo2c	2	921	Bo2b	6	962	"	"	1009	F	4
880	Bo2b	2	923	"	"	963	BDFo2-7	1	1010	F	5
881	BDFo2-11	7	924	ABZo2a	2	964	"	"	1023	Fd	4
882	BFo2c	2	925	Bo2b	6	965	BFo2b	1	1024	"	"
883	ABo2b	3	926	ABo2a	2	966	Bo4b	3	1025	Fd	1
884	Bo2b	2	927	Bo2b	6	967	"	"	1026	"	"
885	"	"	928	Bo2c	5	968	"	"	1027	"	"
886	Bo3a	2	929	"	"	969	"	"	2001	F	2
887	"	"	930	"	"	970	"	"	2007	F	3
888	BFo2c	2	931	Bo2a	2	971	BFo3b	6	2010	F	2
889	Bo3c	1	932	"	"	972	"	"	2011	F	6
890	WLBola	1	934	"	"	973	Bo3c	3	2012	"	"
891	"	"	935	"	"	974	"	"	2013	F	4
892	Bo3c	1	937	DFZo-16	2	975	"	"	2015	F	7
893	"	"	938	"	"	976	BFo2b	4	2016	"	"
894	"	"	939	"	"	977	"	"	2017	"	"
895	"	"	940	BFo2b	3	978	Eo	5	2018	"	"
896	"	"	941	"	"	979	"	"	2019	"	"
897	"	"	942	"	"	980	"	"	2020	"	"
898	ABo3b	1	943	Bo2a	2	981	Bo2b	1	2021	"	"
899	"	"	944	Eo	5	982	"	"	2022	F	10
900	Ao3a	1	945	"	"	983	WLBola	1	2023	F	15
901	Bo2c	4	946	Ao3a	1	984	"	"	2024	F	10
902	Bo2b	5	947	"	"	985	WLAola	1	2025	F	11
903	"	"	948	ABo3b	1	986	"	"	2026	"	"
906	BFo2c	5	949	"	"	987	"	"	2027	"	"
908	Bo2a	1	950	Ao2c	1	988	"	"	2028	"	"
909	"	"	951	Ao2a	1	989	Ao3a	1	2029	F	15

VOGNENE ORDNET I NUMMERORDEN

Nr.	Litra	Type	Nr.	Litra	Type	Nr.	Litra	Type	Nr.	Litra	Type
2030	F	11	5010	F	15	6021	F	11	14952	F	16
3007	F	6	5012	F	10	6022	"	"	15008	F	8
3008	"	"	5013	"	"	6023	F	12	15009	"	"
3009	F	9	5014	"	"	6024	"	"	15010	F	5
3010	"	"	5015	"	"	6025	F	10	15011	"	"
3011	"	"	5016	"	"	7001	F	2	15012	F	8
3012	"	"	5017	FZo	2	7005	F	8	15013	"	"
3017	F	7	5018	"	"	7006	"	"	15014	"	"
3021	F	2	5019	"	"	8002	F	2	15015	"	"
3029	"	"	5020	F	11	8003	"	"	15016	"	"
3030	F	10	5021	"	"	8005	"	"	15017	F	10
3031	"	"	5022	"	"	8487	F	16	15019	Fo	4
3032	"	"	5023	"	"	9001	BF	2	17451	F	11
3033	F	11	5024	"	"	9003	F	6	17952	Fd	5
3034	"	"	5634	F	10	9004	"	"	17953	F	10
3035	"	"	5635	"	"	9006	"	"	17954	"	"
3036	"	"	5678	Fo	5	12101	"	"	17955	"	"
3037	"	"	5679	Fo	1	12102	"	"	17956	Fo	5
3038	"	"	5680	FZo	2	12103	"	"	18001	BFo2t	5
3039	"	"	5681	"	"	12104	"	"	18002	ABo2b	3
3040	Fd	1	6001	F	6	13021	Fd	3	18003	WLBolb	1
3041	"	"	6002	"	"	13022	F	13	18004	ABo3b	3
3042	"	"	6003	"	"	14001	F	6	18005	WLBola	1
3043	"	"	6005	"	"	14002	"	"	18006	Eo	2
3044	Fo	4	6007	"	"	14003	F	5	18007	Bo3c	1
3045	"	"	6008	F	8	14004	Fd	2	18008	"	"
3046	"	"	6010	F	9	14005	F	8	18009	DFo-16	1
3047	"	"	6011	"	"	14006	"	"	18010	DFo-32	1
3552	BF	1	6012	"	"	14007	"	"	18011	Eo	2
3554	F	6	6013	"	"	14008	"	"	18012	Bo2b	2
3555	"	"	6014	F	10	14009	"	"	18013	"	"
3556	"	"	6015	"	"	14010	F	10	18014	"	"
3557	"	"	6016	"	"	14011	"	"	18015	BFo2c	2
3558	"	"	6017	F	11	14012	"	"	18016	BDFo2-7	3
3560	F	4	6018	"	"	14013	Fo	3	18017	"	"
5008	F	2	6019	"	"	14014	"	"	18018	ABo2b	3
5009	F	8	6020	"	"	14015	"	"	18019	BFo2b	6

VOGNENE ORDNET I NUMMERORDEN

Nr.	Litra	Type	Nr.	Litra	Type	Nr.	Litra	Type	Nr.	Litra	Type
18020	BFo2b	6	18061	Bo3c	1	18114	WLBold	1	18172	Bo3d	2
18021	"	"	18062	Bo2b	2	18115	"	"	18173	"	"
18022	"	"	18063	WLBola	1	18116	WLBola	1	19001	Bo2d	1
18023	"	"	18064	Ao2b	1	18117	"	"	19002	"	"
18024	ABo2b	3	18065	ABo2b	3	18118	Bo4d	2	19003	"	"
18025	"	"	18066	"	"	18119	"	"	19004	"	"
18026	Bo2b	2	18074	WLABolb	1	18120	"	"	19005	"	"
18027	"	"	18075	"	"	18121	"	"	19006	"	"
18028	"	"	18076	WLAola	1	18122	"	"	19007	"	"
18029	BDFo2-7	2	18077	Bo3a	1	18123	"	"	19008	"	"
18030	Bo3a	1	18078	"	"	18124	"	"	19009	"	"
18031	"	"	18079	BFo2b	6	18125	WLABola	1	19010	"	"
18033	BDFo2-11	6	18080	BFo2a	4	18126	"	"	19011	"	"
18034	BDFo2-11	3	18081	BDFo2-7	2	18127	ABo3b	3	19012	"	"
18035	Ao2b	1	18082	"	"	18128	"	"	19013	"	"
18036	Bo3c	2	18083	"	"	18129	Bo3a	1	19014	"	"
18037	Bo2b	2	18085	BDFo2-11	3	18130	BFo2b	7	19015	"	"
18038	BEo3a	1	18086	"	"	18131	Bo2b	3	19016	"	"
18039	"	"	18089	DFo-32	2	18132	"	"	19017	"	"
18040	Bo3a	1	18090	BDFo2-11	6	18133	"	"	19018	"	"
18041	"	"	18091	BDFo2-11	4	18134	"	"	19019	"	"
18042	Bo2b	2	18092	BDFo2-7	2	18135	"	"	19020	"	"
18043	BFo2b	6	18097	WLAola	1	18136	Bo3a	2	19021	"	"
18044	"	"	18098	"	"	18137	"	"	19022	"	"
18047	WLAola	1	18099	Bo2b	2	18138	"	"	19023	"	"
18048	WLBolb	1	18100	BFo2b	6	18139	BEo3a	1	19024	"	"
18049	Bo3c	2	18101	WLAola	1	18140	"	"	19025	"	"
18050	WLBolb	1	18102	WLBola	1	18143	Bo2b	3	19026	"	"
18052	BFo2b	6	18103	"	"	18144	"	"	19027	"	"
18053	Bo3a	1	18104	BFo2b	6	18145	"	"	19028	"	"
18054	"	"	18105	"	"	18146	Bo3c	2	19029	"	"
18055	ABo3b	3	18106	Do-39	2	18147	"	"	19030	"	"
18056	WLBola	1	18107	"	"	18148	"	"	19031	Bo3f	1
18057	Bo2b	2	18108	BDFo4-7	2	18149	"	"	19032	"	"
18058	"	"	18109	BDFo2-11	3	18169	BFo3b	5	19033	"	"
18059	Bo3c	1	18110	Bo3a	1	18170	"	"	19034	"	"
18060	"	"	18113	BDF3-4	1	18171	Bo3d	2	19035	"	"

VOGNENE ORDNET I NUMMERORDEN

Nr.	Litra	Type	Nr.	Litra	Type	Nr.	Litra	Type	Nr.	Litra	Type
19036	Bo3f	1	19909	BF3	1	20063	Fo	2	21032	WLABold	2
19037	"	"	19911	"	"	20064	Fo	3	21033	"	"
19038	"	"	19912	"	"	20065	"	"	21034	"	"
19039	"	"	19913	B3	1	20066	"	"	21035	WLABolc	1
19040	"	"	19914	"	"	20773	F	11	21036	"	"
19041	"	"	19915	"	"	20774	"	"	21037	"	"
19042	"	"	19916	"	"	21001	WLAolb	1	21038	"	"
19043	"	"	19918	"	"	21002	"	"	21039	"	"
19044	"	"	19919	"	"	21003	"	"	21040	"	"
19045	"	"	19920	"	"	21004	WLABold	1	21041	"	"
19046	"	"	19921	"	"	21005	"	"	21251	Eo	4
19047	"	"	19922	Bo3g	1	21006	"	"	21252	"	"
19048	"	"	19923	"	"	21007	WLBolc	1	21253	"	"
19049	"	"	19924	"	"	21008	"	"	21254	"	"
19050	"	"	19925	"	"	21009	"	"	21301	DFo-32	4
19051	"	"	19926	"	"	21010	WLAolb	2	21302	"	"
19052	"	"	19927	"	"	21011	"	"	21303	"	"
19053	"	"	19928	"	"	21012	"	"	21304	DFo-37	1
19054	"	"	19929	"	"	21013	"	"	21305	"	"
19055	"	"	19930	Bo3g	2	21014	"	"	21306	"	"
19056	"	"	19951	Fo	6	21015	"	"	21307	"	"
19057	"	"	19952	"	"	21016	WLABold	2	21308	DFo-27	1
19058	"	"	19953	Fo	7	21017	"	"	21309	"	"
19059	"	"	19954	Fdo	2	21018	"	"	21310	"	"
19060	"	"	19955	"	"	21019	WLBold	2	21311	"	"
19061	ABo2c	1	20051	F	10	21020	"	"	21312	"	"
19062	"	"	20052	"	"	21021	"	"	21313	"	"
19063	"	"	20053	"	"	21022	"	"	21501	BFo2d	1
19900	BF3	1	20054	F	11	21023	"	"	21502	"	"
19901	BF3	2	20055	"	"	21024	"	"	21503	"	"
19902	BF3	1	20056	"	"	21025	"	"	21504	BFo2d	2
19903	"	"	20057	"	"	21026	"	"	21505	"	"
19904	"	"	20058	Fdo	1	21027	"	"	21506	"	"
19905	"	"	20059	"	"	21028	"	"	21507	"	"
19906	"	"	20060	"	"	21029	"	"	21508	"	"
19907	"	"	20061	"	"	21030	"	"	21509	"	"
19908	"	"	20062	Fo	2	21031	"	"	21510	"	"

VOGNENE ORDNET I NUMMERORDEN

Nr.	Litra	Type	Nr.	Litra	Type	Nr.	Litra	Type	Nr.	Litra	Type
21511	BFo2d	2									
21512	"	"									
21513	"	"									
21514	"	"									
23101	F	10									
23102	"	"									

OVERSIKT OVER GJELDENE TYPEBLAD I TRYKK NR. 751
pr. 1.7.57. Neste revisjon 1.7.58

Litra	Type	Dato for siste revisjon	Litra	Type	Dato for siste revisjon	Litra	Type	Dato for siste revisjon
Ao	1		ABZo2b	2		Bo4b	4	
"	2		AFo2a	1		Bo4c	1	1.7.57
"	3		B3	1	1.7.57	Bo4d	1	
"	4		Bo2a	1	1.7.57	"	2	1.7.57
WLAola	1	1.7.57	"	2	1.7.57	"	4	1.7.57
WLAolb	1		Bo2b	1	1.7.57	"	5	
"	2		"	2	1.7.57	BDo2-7	1	
WLABola	1		"	3		BDo2-11	1	
WLABolb	1	1.7.57	"	4		"	2	
WLABold	1		"	5		BDo2-16	1	
"	2	1.7.57	"	6	1.7.57	BDF3-4	1	
WLBola	1	1.7.57	Bo2c	1		BDFo2-4	1	1.7.57
WLBolb	1	1.7.57	"	2		BDFo2-7	1	1.7.57
WLBolc	1		"	3		"	2	
WLBold	1		"	4		"	3	
"	2	1.7.57	"	5	1.7.57	BDFo2-11	1	
Ao2a	1	1.7.57	Bo2d	1	1.7.57	"	2	
"	2	1.7.57	Bo3a	1	1.7.57	"	3	
Ao2b	1		"	2	1.7.57	"	4	
Ao2c	1	1.7.57	Bo3b	1	1.7.57	"	5	
Ao2d	1	1.7.57	"	2		"	6	1.7.57
Ao3a	1		"	3		"	7	1.7.57
ABo2a	1		"	4		BDFo3-7	1	
"	2		"	5	1.7.57	"	2	
ABo2b	1		Bo3c	1	1.7.57	BDFo3-11	1	
"	2		"	2		BDFo3-16	1	1.7.57
"	3	1.7.57	"	3		BDFo4-7	1	1.7.57
ABo2c	1		Bo3d	1		"	2	1.7.57
ABo3a	1	1.7.57	"	2		BEo3a	1	
ABo3b	1	1.7.57	Bo3f	1		BF	1	
"	2		Bo3g	1	1.7.57	"	2	
"	3		"	2	1.7.57	BF2a	1	
ABFo2a	1		Bo4a	1		"	2	
ABZo2a	1		Bo4b	1		BF2b	1	1.7.57
"	2	1.7.57	"	2		BF3	1	
ABZo2b	1		"	3		BF3a	1	
						"	2	

Der hvor datorubrikken står åpen gjelder datoen for den opprinnelige utgave: 1.7.56.

OVERSIKT OVER GJELDENE TYPEBLAD I TRYKK NR. 751
pr. 1.7.57. Neste revisjon 1.7.58

Litra	Type	Dato for siste revisjon	Litra	Type	Dato for siste revisjon	Litra	Type	Dato for siste revisjon
BF3b	1		Do-39	1	1.7.57	F	15	
"	2		"	2	1.7.57	"	16	
BFo2a	1		DFo-16	1	1.7.57	Fo	1	1.7.57
"	2		"	2	1.7.57	"	2	
"	3		DFo-18	1		"	3	1.7.57
"	4		DFo-21	1	1.7.57	"	4	
"	5		DFo-22	2	1.7.57	"	5	1.7.57
"	6		"	3		"	6	
BFo2b	1		"	4		"	7	
"	2	1.7.57	"	5		Fd	1	1.7.57
"	3		DFo-27	1		"	2	1.7.57
"	4	1.7.57	DFo-29	1		"	3	
"	5		DFo-32	1		"	4	
"	6	1.7.57	"	2		"	5	
"	7		"	3		Fdo	1	1.7.57
"	8		"	4	1.7.57	"	2	1.7.57
BFo2c	1	1.7.57	DFo-37	1	1.7.57	FZo	2	1.7.57
"	2	1.7.57	DFZo-16	1		Zo	1	
"	3		"	2		"	2	
"	4		Eo	1	1.7.57	Zu	1	1.7.57
"	5		"	2	1.7.57	Zuo	1	
"	6		"	3		"	2	
"	7		"	4		"	3	1.7.57
BFo2d	1		"	5	1.7.57			
"	2		F	2	1.7.57			
BFo3a	1		"	3				
"	2		"	4				
BFo3b	1		"	5				
"	2		"	6	1.7.57			
"	3		"	7				
"	4		"	8	1.7.57			
"	5		"	9				
"	6		"	10	1.7.57			
BFo4a	1		"	11	1.7.57			
"	2		"	12				
BFZo2a	1		"	13				

Der hvor datorubrikken står åpen gjelder datoen for den opprinnelige utgave: 1.7.56.

OVERSIKT OVER GJELDENE TYPEBLAD I TRYKK NR. 751

pr. 1.7.58. Neste revisjon 1.7.59

Litra	Type	Dato for siste revisjon	Litra	Type	Dato for siste revisjon	Litra	Type	Dato for siste revisjon
Ao	1		AFo2a	1		Bo4c	1	1.7.57
"	2		B3	1	1.7.57	Bo4d	1	
"	3		Bo2a	1	1.7.58	"	2	1.7.58
"	4		"	2	1.7.58	"	4	1.7.57
WLAo1a	1	1.7.57	Bo2b	1	1.7.57	"	5	
WLAo1b	1		"	2	1.7.58	BDo2-7	1	
"	2		"	3		BDo2-11	1	
WLABo1a	1		"	4		"	2	
WLABo1b	1	1.7.58	"	5		BDo2-16	1	
WLABo1c	1	1.7.58	"	6	1.7.58	BDF3-4	1	1.7.58
WLABo1d	1		Bo2c	1		BDFo2-4	1	1.7.57
"	2	1.7.58	"	2		BDFo2-7	1	1.7.57
WLBola	1	1.7.58	"	3		"	2	
WLBolb	1	1.7.57	"	4		"	3	
WLBolc	1	1.7.58	"	5	1.7.58	BDFo2-11	1	
WLBold	1	1.7.58	Bo2d	1	1.7.58	"	2	
"	2	1.7.57	Bo3a	1	1.7.58	"	3	1.7.58
Ao2a	1	1.7.58	"	2	1.7.58	"	4	1.7.58
"	2	1.7.58	Bo3b	1	1.7.57	"	6	1.7.58
Ao2b	1		"	2		"	7	1.7.58
Ao2c	1	1.7.58	"	3	1.7.58	BDFo3-7	1	
Ao2d	1	1.7.57	"	4	1.7.58	"	2	
Ao3a	1		"	5	1.7.57	BDFo3-11	1	
ABo2a	2	1.7.58	Bo3c	1	1.7.58	BDFo3-16	1	1.7.57
ABo2b	1		"	2	1.7.58	BDFo4-7	1	1.7.57
"	2		"	3	1.7.58	"	2	1.7.57
"	3	1.7.57	Bo3d	1	1.7.58	BEo3a	1	
ABo2c	1		"	2		BF	1	
ABo3a	1	1.7.57	Bo3f	1	1.7.58	"	2	
ABo3b	1	1.7.57	Bo3g	1	1.7.57	BF2a	1	
"	2		"	2	1.7.57	"	2	
"	3		Bo4a	1	1.7.58	BF2b	1	1.7.57
ABZo2a	1		Bo4b	1		BF3	1	1.7.58
"	2	1.7.58	"	2		BF3	2	1.7.58
ABZo2b	1		"	3		BF3a	1	1.7.58
"	2		"	4		"	2	

Der hvor datorubrikken står åpen gjelder datoen for den opprinnelige utgave: 1.7.56.

OVERSIKT OVER GJELDENE TYPEBLAD I TRYKK NR. 751
pr. 1.7.58. Neste revisjon 1.7.59

Litra	Type	Dato for siste revisjon	Litra	Type	Dato for siste revisjon	Litra	Type	Dato for siste revisjon
BF3b	1		Do-39	1	1.7.57	Fo	1	1.7.57
"	2		"	2	1.7.57	"	2	
BFo2a	1		DFo-16	1	1.7.57	"	3	1.7.57
"	2		"	2	1.7.57	"	4	
"	3		DFo-21	1	1.7.57	"	5	1.7.57
"	4		DFo-22	2	1.7.57	"	6	1.7.58
"	5		"	3	1.7.58	"	7	
"	6	1.7.58	"	4		"	8	1.7.58
BFo2b	1		"	5		Fd	1	1.7.57
"	2	1.7.57	DFo-27	1		"	2	1.7.57
"	3	1.7.58	DFo-29	1		"	3	1.7.58
"	4	1.7.58	DFo-32	1		"	4	
"	5		"	2	1.7.58	"	5	
"	6	1.7.58	"	3		Fdo	1	1.7.57
"	7	1.7.58	"	4	1.7.58	"	2	1.7.57
"	8		DFo-37	1	1.7.58	FZo	2	1.7.58
BFo2c	1	1.7.57	DFZo-16	1		Zo	1	
"	2	1.7.58	"	2	1.7.58	"	2	
"	3	1.7.58	Eo	2	1.7.57	Zu	1	1.7.57
"	4		"	3	1.7.58	Zuo	1	
"	5		"	4		"	2	
"	6		"	5	1.7.58	"	3	1.7.57
"	7		F	2	1.7.57			
BFo2d	1	1.7.58	"	3				
"	2		"	4				
BFo3a	1		"	5	1.7.58			
"	2	1.7.58	"	6	1.7.58			
BFo3b	1		"	7	1.7.58			
"	2		"	8	1.7.58			
"	3		"	9	1.7.58			
"	4		"	10	1.7.58			
"	5		"	11	1.7.58			
"	6		"	12				
BFo4a	1		"	13	1.7.58			
"	2		"	15				
BFZo2a	1		"	16				

Der hvor datorubrikken står åpen gjelder datoen for den opprinnelige utgave: 1.7.56.

LITRAOVERSIKT VED OVERGANG TIL NY LITRA 3.6.1956

Nåværende		Tidligere		Nåværende		Tidligere		Nåværende		Tidligere	
Litra	Type	Litra	Type	Litra	Type	Litra	Type	Litra	Type	Litra	Type
Ao	1	Ao	1	WLBola	1	Cola	1	Bo4b	2	Co4b	2
"	2	"	2	WLBolb	1	Colb	1	"	3	"	3
"	3	"	3	WLBolc	1	Colc	1	"	4	"	4
"	4	"	4	WLBold	1	Cold	1	Bo4c	1	Co4c	1
WLAola	1	Aola	1	"	2	"	2	Bo4d	1	Co4d	2
WLAolb	1	Aolb	1	Bo2a	1	Co2a	2	"	2	"	4
"	2	"	2	"	2	"	3	"	4	"	5
WLABola	1	ACola	1	Bo2b	1	Co2b	1	"	5	"	1
WLABolb	1	AColb	1	"	2	"	2	BDo2-16	1	CDo2a	1
WLABold	1	ACold	1	"	3	"	3	BDo2-11	1	CDo2b	1
"	2	"	2	"	4	"	4	"	2	"	2
Ao2a	1	Bo2a	2	"	5	"	5	BDo2-7	1	CDo2c	1
"	2	"	3	"	6	"	6	BDFo2-11	1	CDFo2b	1
Ao2b	1	Bo2b	1	Bo2c	1	Co2c	2	"	2	"	2
Ao2c	1	Bo2c	3	"	2	"	3	"	3	"	3
"	2	"	4	"	3	"	4	"	4	"	4
Ao2d	1	Bo2c	5	"	4	"	6	"	5	"	5
Ao3a	1	Bo3a	1	"	5	Bo2a	2	"	6	"	3
		Bo3b	2	Bo2d	1	Co2d	1	"	7	CDFo2d	3
ABo2a	1	BCo2a	2	Bo3a	1	Co3a	1	BDFo2-7	1	CDFo2c	1
"	2	"	3	"	2	"	2	"	2	"	2
ABo2b	1	BCo2b	2	Bo2-3a	1	Co2-3a	1	"	3	"	3
"	2	"	3	Bo3b	1	Co3b	2	BDFo2-4	1	CDFo2d	1
"	3	"	4	"	2	"	3	"	2	"	3
ABo2c	1	BCo2e	1	"	3	"	4	BDF3-4	1	CDF3a	1
ABo3a	1	BCo3a	1	"	4	"	5	BDFo3-7	1	CDFo3a	1
ABo3b	1	BCo3b	1	"	5	"	6	"	2	"	2
"	2	"	2	Bo3c	1	Co3c	1	BDFo3-11	1	"	5
"	3	"	3	"	2	"	2	BDFo3-16	1	CDFo3c	1
ABFo2a	1	BCFo2b	1	"	3	"	3	BDFo4-7	1	CDFo4a	1
ABZo2a	1	BCZo2a	1	Bo3d	1	Co3d	1	"	2	CDFo4b	2
"	2	"	2	"	2	"	2	BEo3a	1	CEo3b	1
ABZo2b	1	BCZo2b	2	Bo3f	1	Co3f	1	BF	1	CF	5
"	2	"	3	Bo3g	1	Co3g	1	"	2	"	6
AFo2a	1	BFo2a	1	Bo4a	1	Co4a	1	BF2a	1	CF2a	1
B3	1	C3		Bo4b	1	Co4b	1	"	2	"	2

LITRAOVERSIKT VED OVERGANG TIL NY LITRA 3.6.1956

Nåværende		Tidligere		Nåværende		Tidligere		Nåværende		Tidligere	
Litra	Type	Litra	Type	Litra	Type	Litra	Type	Litra	Type	Litra	Type
BF2b	1	CF2b	1	BFo3b	5	CFo3b	5	F	7	F	7
BF3	1	CF3	1	"	6	"	6	"	8	"	8
BF3a	1	CF3a	1	BFo4a	1	CFo4a	1	"	9	"	9
"	2	"	2	"	2	"	2	"	10	"	10
BF3b	1	CF3b	3	BFZo2a	1	CFZo2a	1	"	11	"	11
"	2	"	2	Do-39	1	Do	4	"	12	"	12
BFo2a	1	CFo2d	1	"	2	"	2	"	13	"	20
"	2	"	2	DFo-16	1	DFo	21	"	14	"	14
"	3	"	3	"	2	"	15	"	15	"	15
"	4	"	4	DFo-18	1	"	2	"	16	"	16
"	5	"	5	DFo-21	1	"	10	"	17	"	17
"	6	"	6	DFo-22	1	"	4	Fo	1	Fo	1
BFo2b	1	CFo2b	9	"	2	"	17	"	2	"	2
"	2	"	2	"	3	"	16	"	3	"	3
"	3	"	10	"	4	"	20	"	4	"	4
"	4	"	4	"	5	"	2	"	5	"	5
"	5	"	5	DFo-27	1	"	19	"	6	"	5
"	6	"	6	DFo-29	1	"	13	"	7	"	
"	7	"	7	DFo-32	1	"	7	Fd	1	Fd	8
"	8	"	8	"	2	"	9	"	2	"	2
"	9	CFo2a	1	"	3	"	15	"	3	"	3
BFo2c	1	CFo2c	1	"	4	"	14	"	4	"	6
"	2	"	2	DFo-37	1	"	18	"	5	"	5
"	3	"	3	DFZo-16	1	DFZo	1	Fdo	1	Fdo	2
"	4	"	4	"	2	"	2	"	2	"	
"	5	"	5	Eo	1	Eo	1	FZo	1	FZo	1
"	6	"	6	"	2	"	2	"	2	"	2
"	7	CFo2b	1	"	3	"	3	Zo	1	Zo	1
BFo2d	1	CFo2c	1	"	4	"	4	"	2	"	2
"	2	"	2	"	5	"	1	Zu	1	Zu	1
BFo3a	1	CFo3a	1	F	1	F	1	Zuo	1	Zuo	1
"	2	"	2	"	2	"	2	"	2	"	2
BFo3b	1	CFo3b	1	"	3	"	3	"	3	"	3
"	2	"	2	"	4	"	4				
"	3	"	3	"	5	"	5				
"	4	"	4	"	6	"	6				

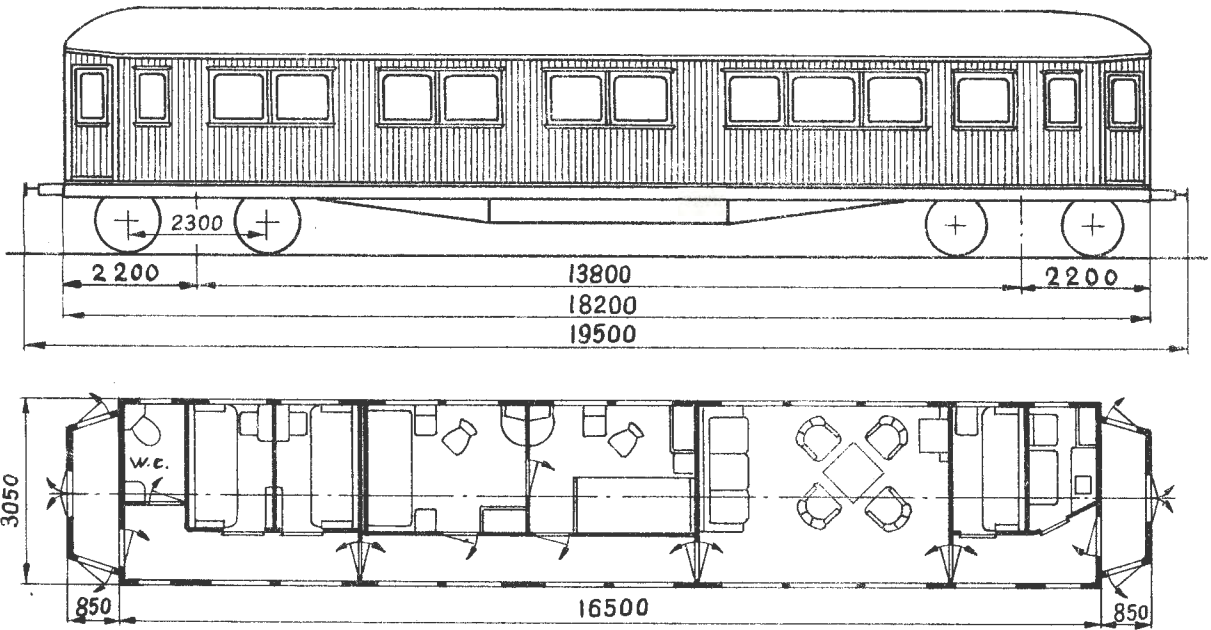

Oppr. hovedt. 1110¹⁾

Vogn nr.	Distriktsmerke	Fabrikant	Byggeår	Omtr. vognvekt i tonn	Sittepl. pr. vogn		Grunnriis	El. varme i kW	Vognutstyr (se side 6)	Merknad
					1	2				
206	0	Str	10	33,0				25	1H.3.5.11.28.35.39a	

1) Forandr. etter skisse 454
Trykk nr. 751 1.7.56

Ao

TYPE 2

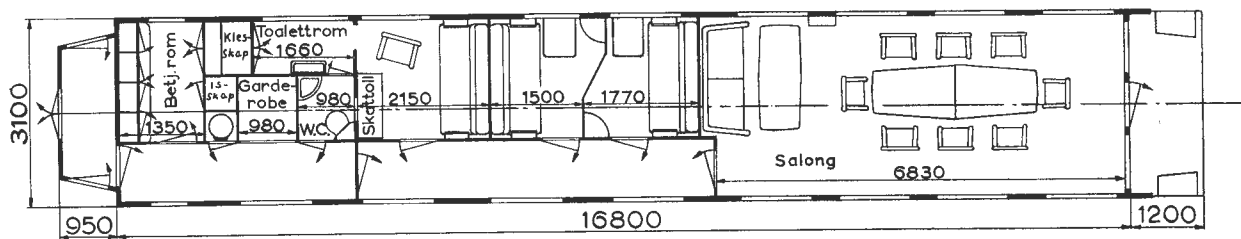
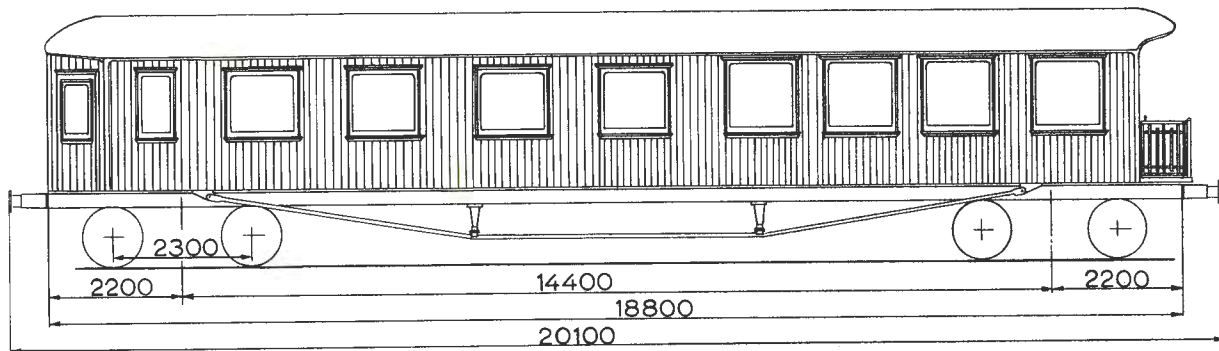

Oppr. hovedt. 2955

Vogn nr.	Distriktsmerke	Fabrikant	Byggeår	Omtr. vognvekt i tonn	Sittepl. pr. vogn				Liggepl. pr. vogn		Grunnriss	El. varme i kW	Vognutstyr (se side 6)	Merknad
					1		2		1	2				
					klasse		klasse		klasse					
100	O	Skb	26	34,0	10				6			1H.3. 5. 11. 28. 39a.		

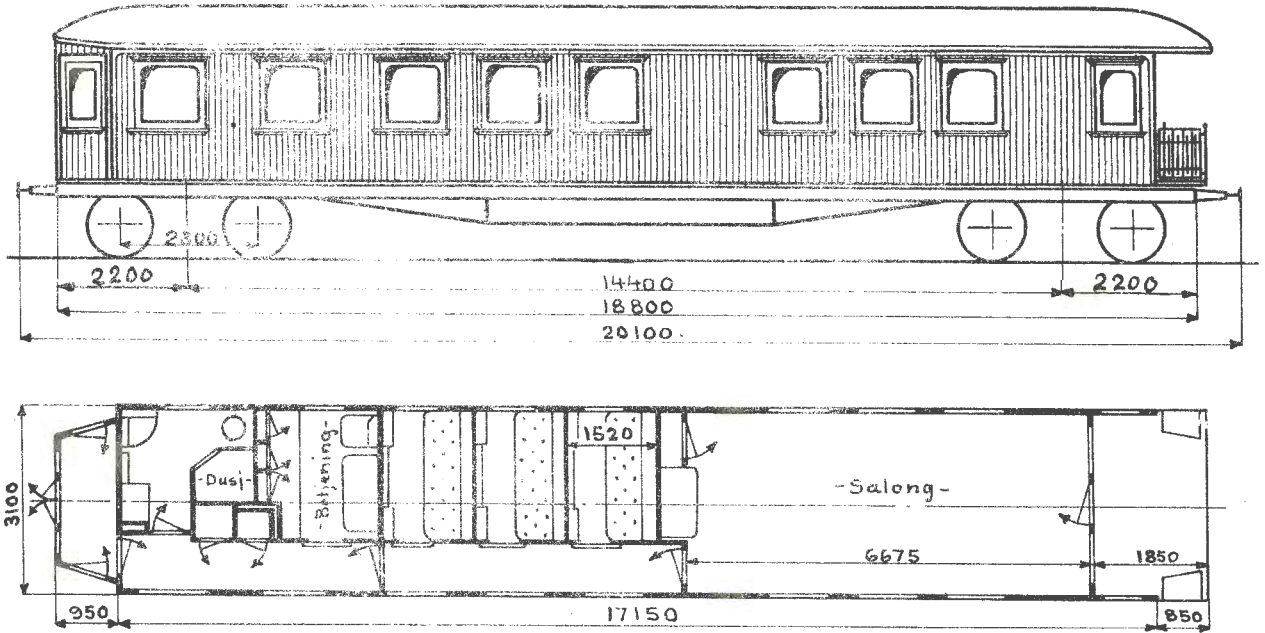

Hovedt. 2771

Vogn nr	Distriktsmerke	Fabrikant	Byggeår	Omr. vognvekt i tonn	Sittepl. pr vogn		Liggepl. pr vogn		Grunnriss	El. varme i kW	Vognutstyr (se side 6)	Merknad
					1	2	1	2				
118	0	SKB	23	36,0				6			1KK.3.5.11.28.35.39a	

Ao

TYPE 4

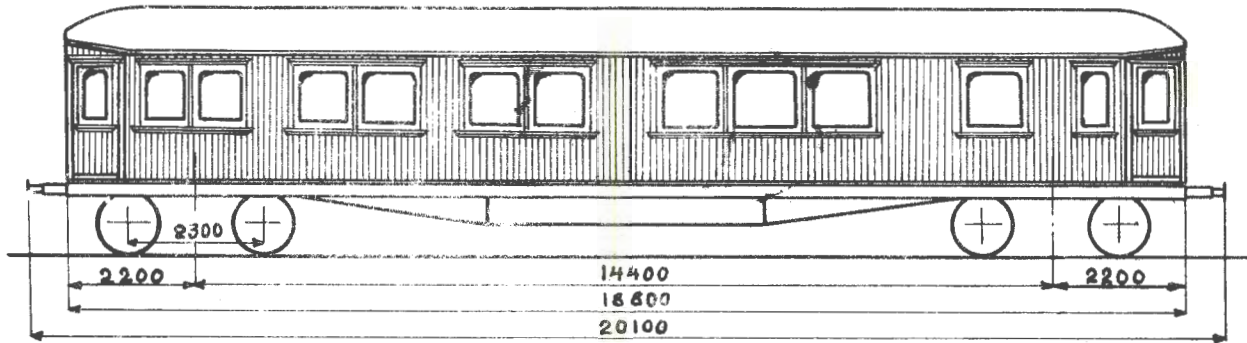

Grunnriss 1

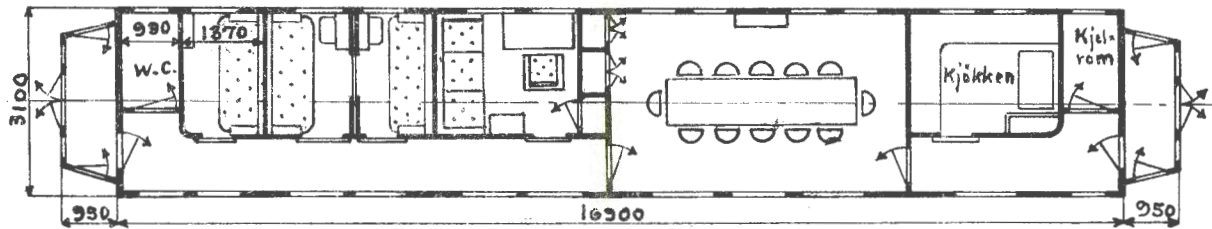

Grunnriss 2

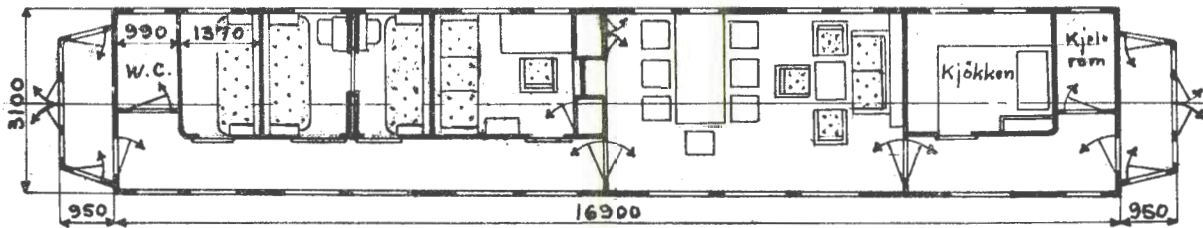

Oppr. hovedt. 2541¹⁾

Vogn nr.	Distriktsmerke	Fabrikant	Byggeår	Omtr. vognvekt i tonn	Sittepl. pr. vogn				Liggepl. pr. vogn	Grunnriss	El. varme i kW	Vognutstyr (se side 6)	Merknad
					1		2						
					klasse	klasse	klasse	klasse					
702	H	Skb	23	35,5						2	1KK.3.6.11.28.39a.41		
704	"	"	24	35,0						1	1H.3.6.11.28.39a.41		

1) forandr. etter skisse 646

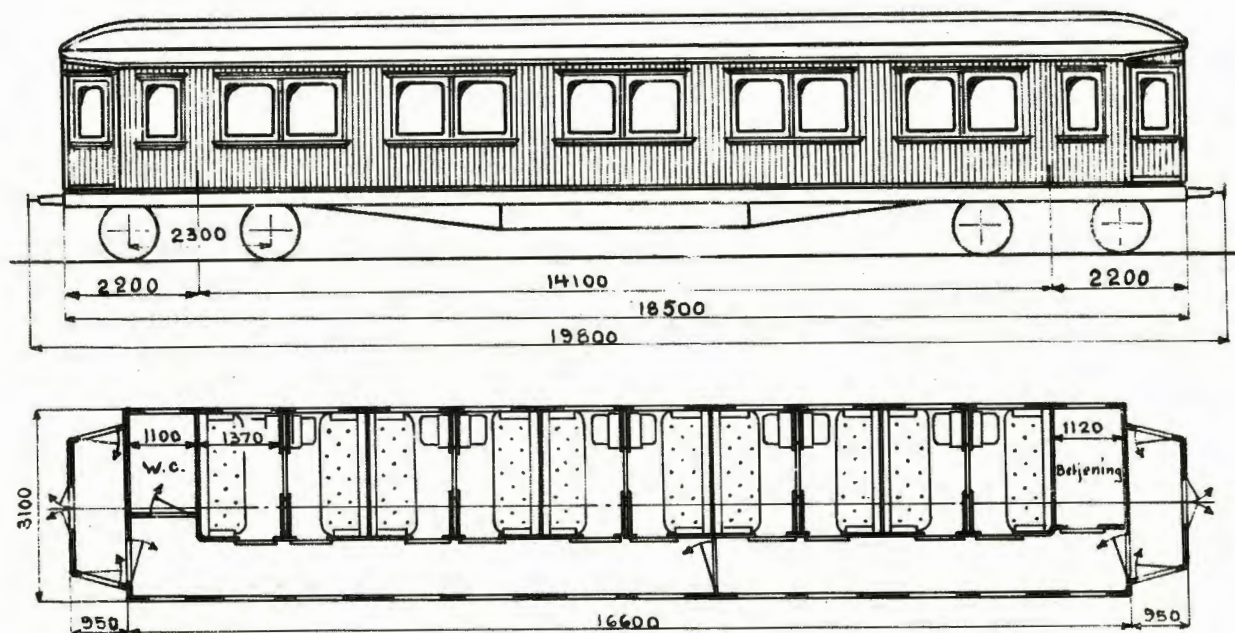

Hovedt. 2059
2222

Vogn nr.	Distriktsmerke	Fabrikant	Byggeår	Omr. vognvekt i tonn	Sittepl. pr. vogn		Liggepl. pr. vogn		Grunnriss	El. varme i kW	Vognutstyr (se side 6)	Merknad
					1	2	1	2				
					klasse		klasse					
103	0	Skb	13	35,5	30		20			1KK.3.5.11.28.35.39a	1)	
104	"	"	"	36,0	"		"			1KK.3.5.11.28.35.39a	1)	
105	"	"	"	35,5	"		"			1H.3.5.11.28.35.39a	1) Dør mellom kupéer er blindet	
201	"	Kok	21	36,5	"		"			1KK.3.5.11.28.39a		
202	"	"	"	37,0	"		"			1KK.3.5.11.28.39a		
210	"	"	"	36,0	"		"			1KK.3.5.11.28.39a		
602	D	"	"	37,0	"		"			1H.3.5.11.28.39a		
701	H	"	"	36,5	"		"			1KK.3.5.11.28.39a		
985	B	Skb	12	34,5	"		"			1H.3.5.11.28.39a	1)	
986	"	"	"	"	"		"			1H.3.5.11.28.39a	1)	
987	"	"	"	34,0	"		"			1H.3.5.11.28.39a	1)	
988	"	"	"	35,5	"		"			1H.3.5.11.28.39a	1)	
991	"	"	13	34,0	"		"			1H.3.5.11.28.39a	1)	
992	"	"	"	33,5	"		"			1H.3.5.11.28.39a	1)	
995	"	"	19	35,0	"		"			1H.3.5.11.28.39a		
18047	T	"	17	37,0	"		"			1H.3.5.11.28.39a		
18076	B	Kok	21	35,0	"		"			1H.3.5.11.28.39a		
18097	"	"	"	34,0	"		"			1H.3.5.11.28.39a		
18098	"	"	"	35,0	"		"			1H.3.5.11.28.39a		
18101	D	"	"	34,5	"		"			1H.3.5.11.28.39a		

1) Hovedt. 2059

Trykk nr. 751 1.7.57

WLAo1b

TYPE 1
Stålvogner

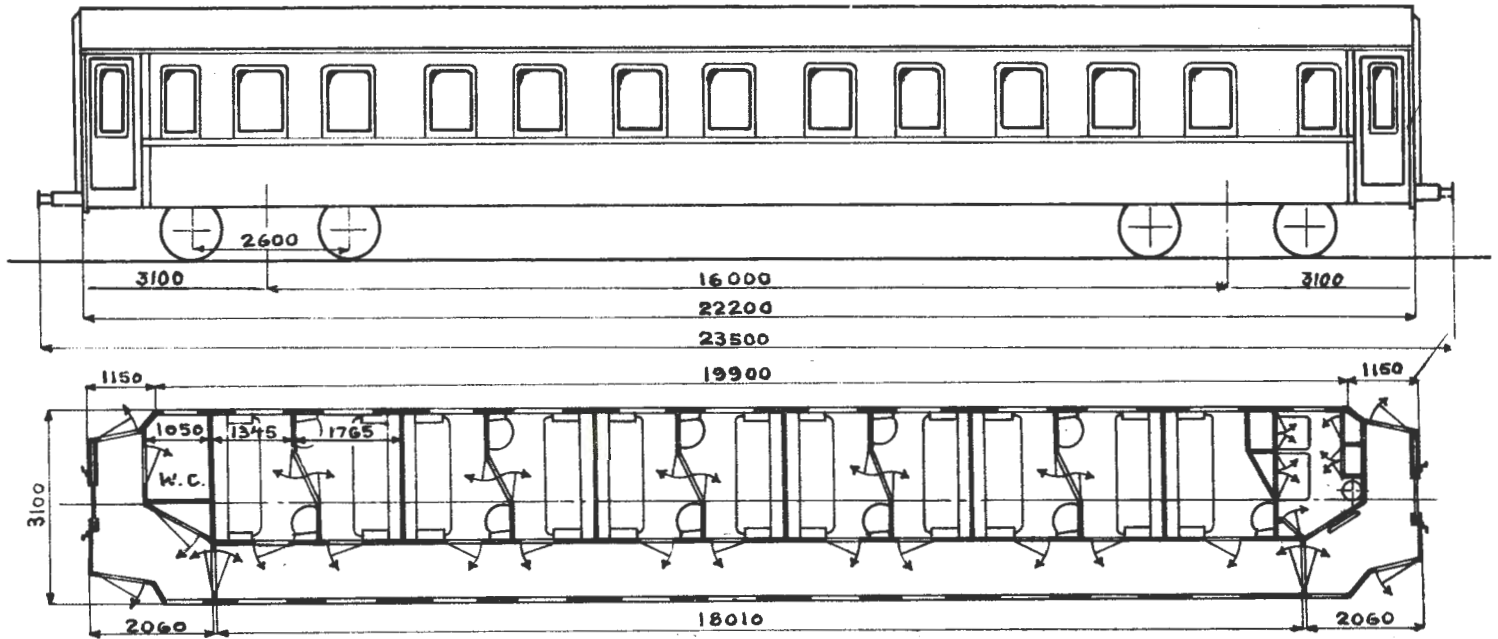

Hovedt. 4300

Vogn nr.	Distriktsmerke	Fabrikant	Byggeår	Omr. vognvekt i tonn	Sittepl. pr. vogn		Liggepl. pr. vogn		Grunnriss	El. varme i kW	Vognutstyr (se side 6)	Merknad
					1	2	1	2				
					klasse		klasse					
21001	0	Str	39	40,5	33		22		45	1H.3.5.11.28.39b		
21002	"	"	"	39,5	"		"		"	1H.3.5.11.28.39b		
21003	"	"	"	40,0	"		"		"	1H.3.5.11.28.39b		

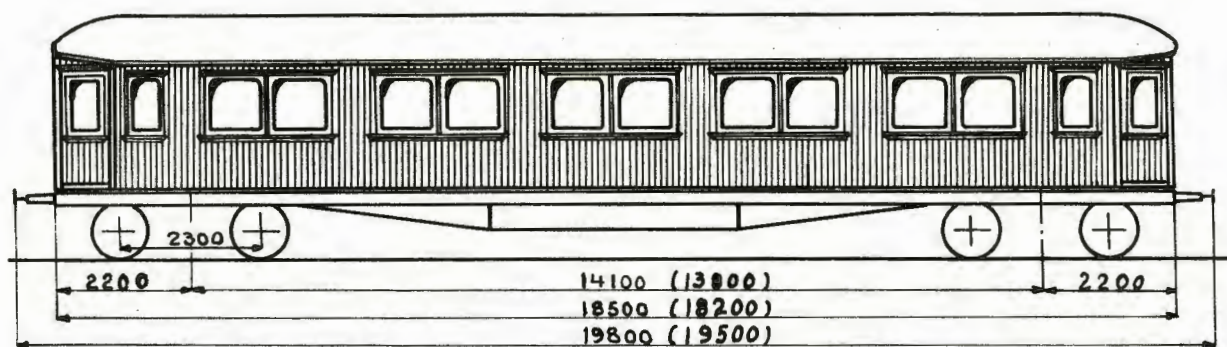

Mål i () gjelder vogn nr. 207

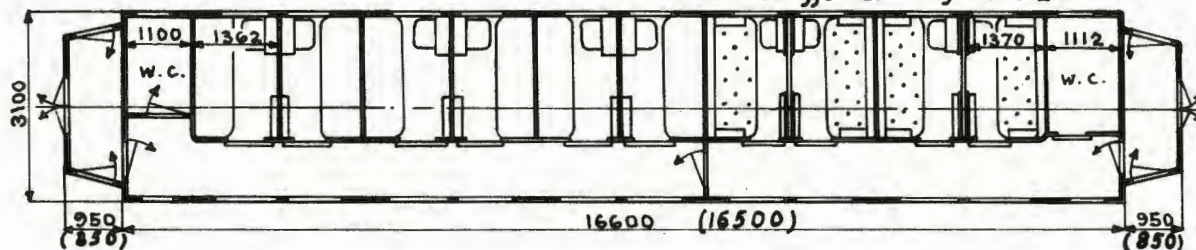

Oppr. hovedt. $\left. \begin{matrix} 1110 \\ 2059 \\ 2222 \end{matrix} \right\} \begin{matrix} 1) \\ 1) \\ 1) \end{matrix}$

Vogn nr	Distriktsmerke	Fabrikant	Byggeår	Omr. vognvekt i tonn	Sittepl. pr. vogn		Liggepl. pr. vogn		Grunnriss	El. varme i kW	Vognutstyr (se side 6)	Merknad
					1	2	1	2				
					klasse		klasse					
106	0	Skb	13	37,0	12	24	8	18			1KK.3.5.11.28.35.39a	3)
207	"	Str	10	35,5	"	"	"	"			1H.3.5.11.28.35.39a	2)
208	"	Skb	12	35,0	"	"	"	"			1KK.3.5.11.28.35.39a	3)
18074	D	Kok	21	34,0	"	"	"	"			1H.3.5.11.28.39a	4)
18075	"	"	"	"	"	"	"	"			1H.3.5.11.28.39a	4)

- 1) Forandr. etter tegn. 3817
- 2) Hovedt. 1110
- 3) " 2059
- 4) " 2222

WLAB01d

TYPE 1

Stålvogner

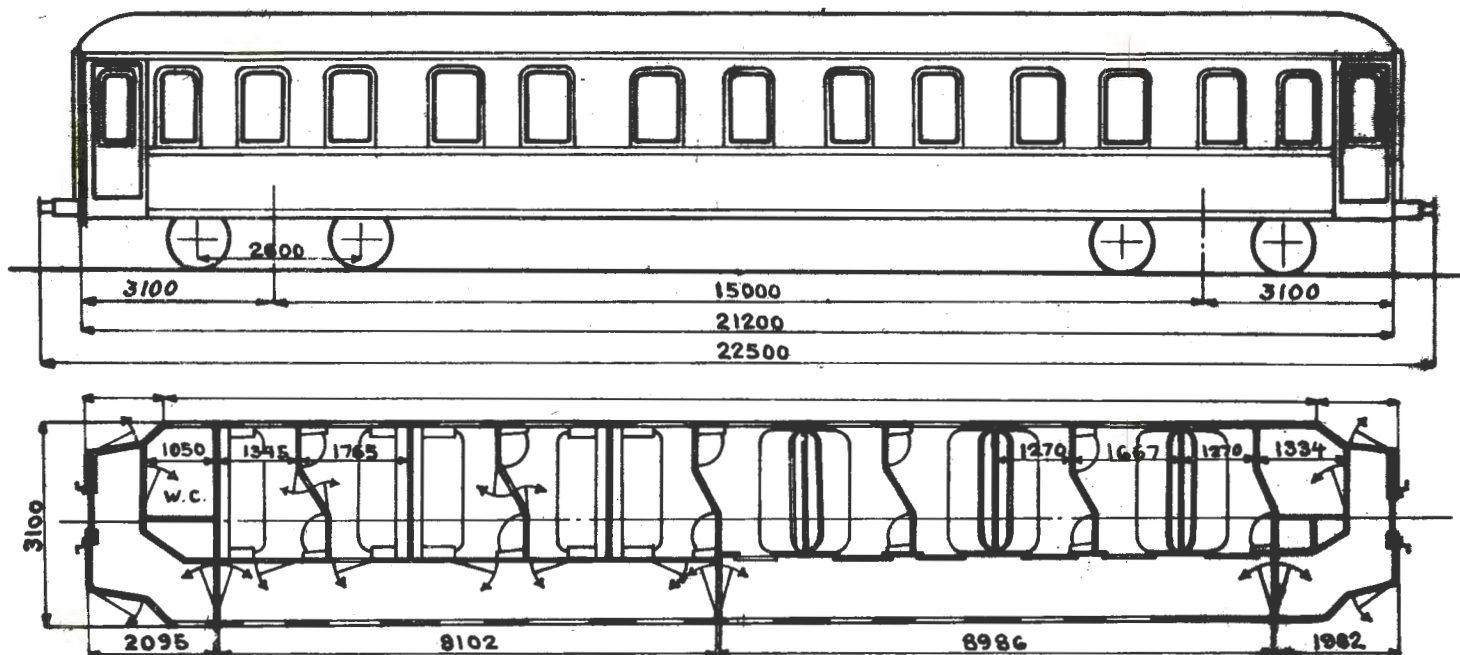

Hovedt. 4725

Vogn nr.	Distriktsmerke	Fabrikant	Byggear	Omr. vognavekt i tonn	Sittepl. pr. vogn				Liggepl. pr. vogn		Grunnriis	El. varme i kW	Vognutstyr (se side 6)	Merknad
					1		2		1	2				
					klasse		klasse							
21004	0	Skb	40	37,0	15	24	10	18			45	1H.3.5.11.28.39b		
21005	"	"	"	39,0	"	"	"	"			"	1H.3.5.11.28.39b		
21006	"	"	"	37,0	"	"	"	"			"	1H.3.5.11.28.39b		

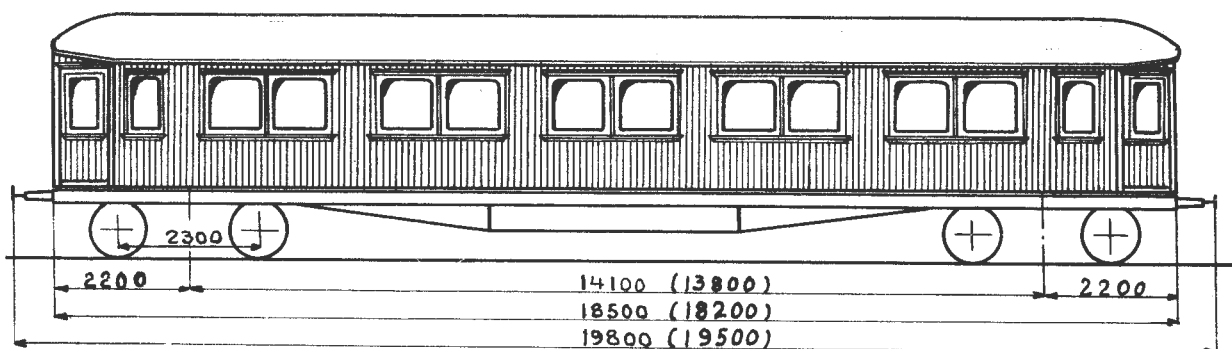

Mål i () gjelder vogn nr. 207

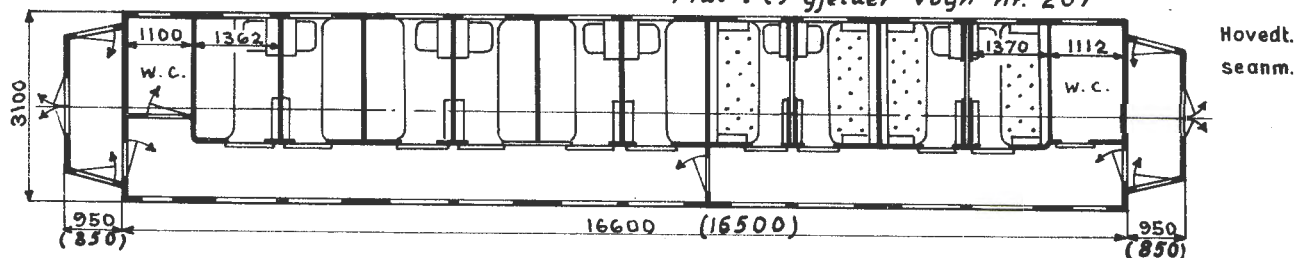

Oppr. hovedt. $\left. \begin{array}{l} 1110 \\ 2059 \\ 2222 \end{array} \right\}^1$

Vogn nr.	Distriktsmerke	Fabrikant	Byggeår	Omtr. vognvekt i tonn	Sittepl. pr vogn		Liggepl. pr vogn		Grunnriis	El. varme i kW	Vognutstyr (se side 6)	Merknad
					1	2	1	2				
					klasse		klasse					
106	0	Skb	13	37,0	12	24	8	18			1KK.3.5.11.28.35.39a	3)
207	"	Str	10	35,5	"	"	"	"			1H.3.5.11.28.35.39a	2)
208	"	Skb	12	35,0	"	"	"	"			1KK.3.5.11.28.35.39a	3)
18074	D	Kok	21	34,0	"	"	"	"			1H.3.5.11.28.39a	4)
18075	"	"	"	35,5	"	"	"	"			1H.3.5.11.28.39a	4)

1) Forandr. etter tegn. 3817

2) Hovedt. 1110

3) " 2059

4) " 2222

Trykk nr. 751 1.7.58

WLAB01c

TYPE 1

Stålvogner

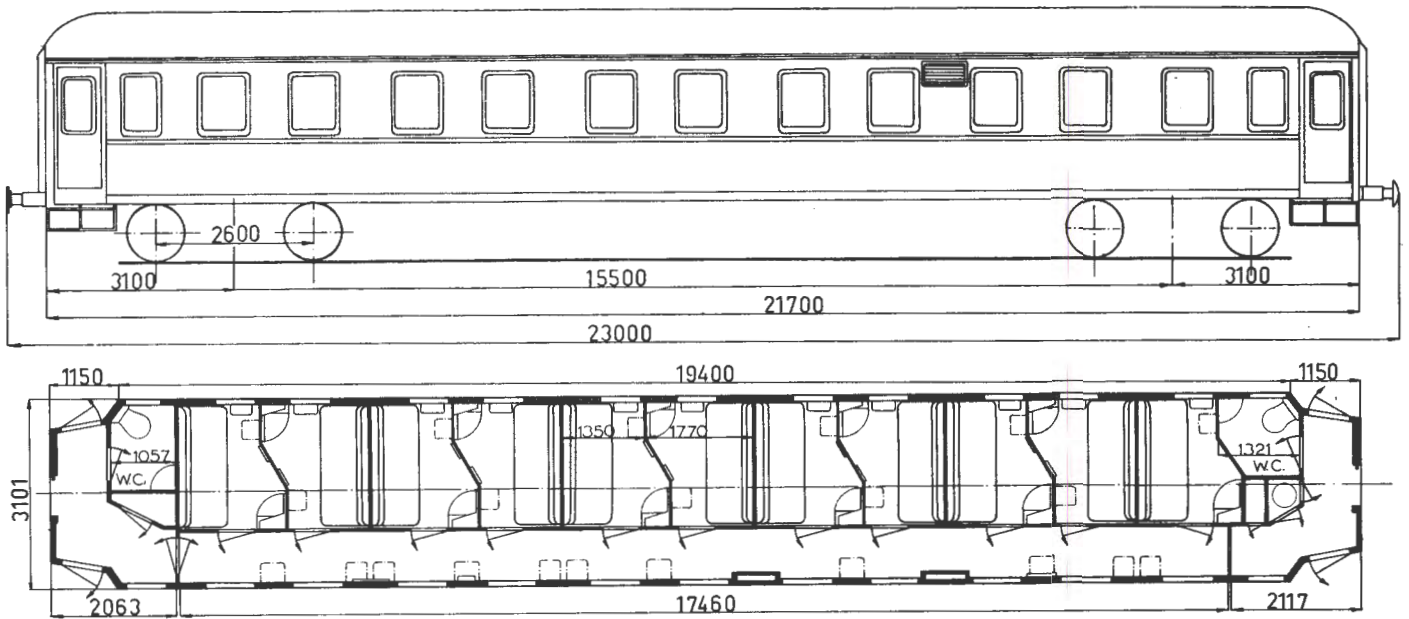

Hovedt. 7450

Vogn nr.	Distriktsmerke	Fabrikant	Byggeår	Omr. vognvekt i tonn	Sittepl. pr. vogn		Liggepl. pr. vogn		Grunnriss	EL-varme i KW	Vognutstyr (se side 6)	Merknad
					1	2	1	2				
					klasse		klasse					
21035	B	Skb	57	41,0	33 ^y	44 ^y	22 ^y	33 ^y	47	1KE. 3. 5. 11. 28. 39ab		
21036	"	"	"	40,5	"	"	"	"	"	1KE. 3. 5. 11. 28. 39ab		
21037	"	"	"	41,5	"	"	"	"	"	1KE. 3. 5. 11. 28. 39ab		
21038	"	"	58	"	"	"	"	"	"	1KE. 3. 5. 11. 28. 39ab		
21039	O	"	"	"	"	"	"	"	"	1KE. 3. 5. 11. 28. 39ab		
21040	"	"	"	"	"	"	"	"	"	1KE. 3. 5. 11. 28. 39ab		
21041	"	"	"	41,0	"	"	"	"	"	1KE. 3. 5. 11. 28. 39ab		

1) Køyene er regulerbare slik at den enkelte kupé kan nyttas enten som 2.kl.1.kl. eller single
Trykk nr. 751 1.7.58

WLABo1d

TYPE 1
Stålvogner

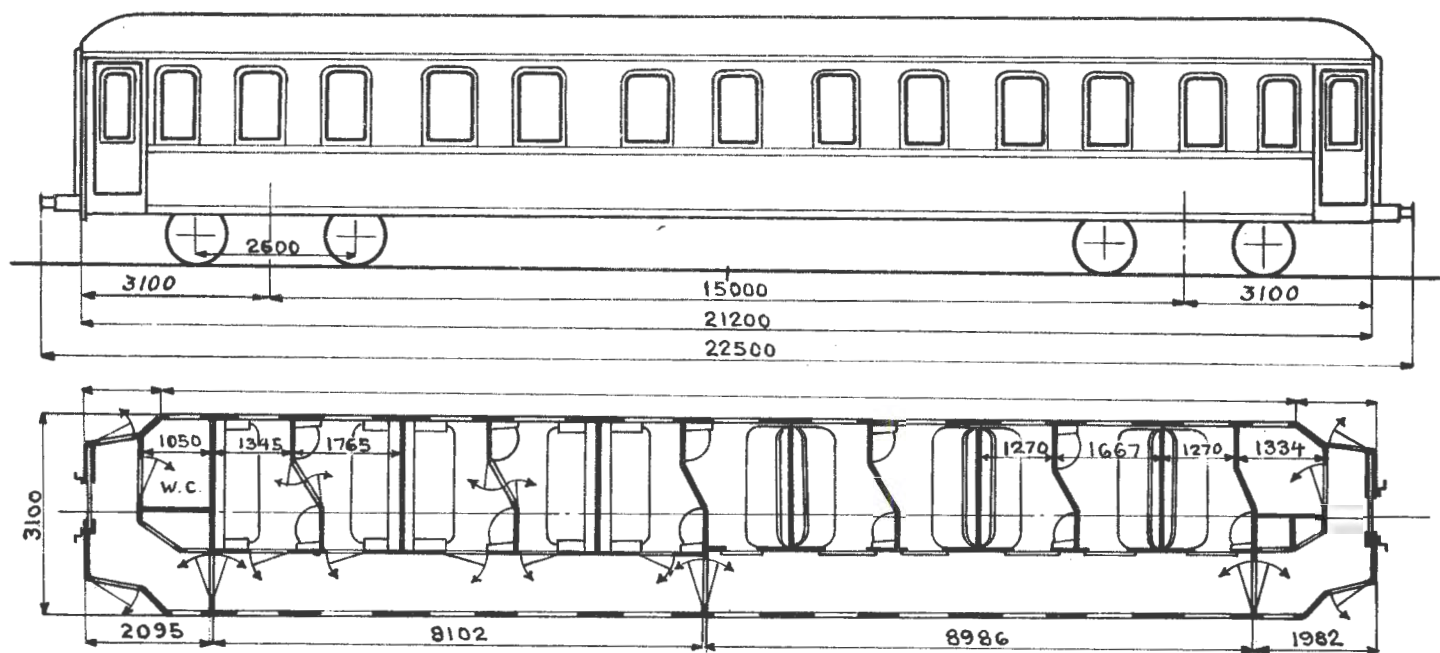

Hovedt. 4725

Vogn nr.	Distriktsmerke	Fabrikant	Byggeår	Omr. vognvekt i tonn	Sittepl. pr. vogn		Liggepl. pr. vogn		Grunnriss	El. varme i kW	Vognutstyr (se side 6)	Merknad
					1	2	1	2				
					klasse		klasse					
21004	0	Skb	40	37,0	15	24	10	18	45	1H.3.5.11.28.39b		
21005	"	"	"	39,0	"	"	"	"	"	1H.3.5.11.28.39b		
21006	"	"	"	37,0	"	"	"	"	"	1H.3.5.11.28.39b		

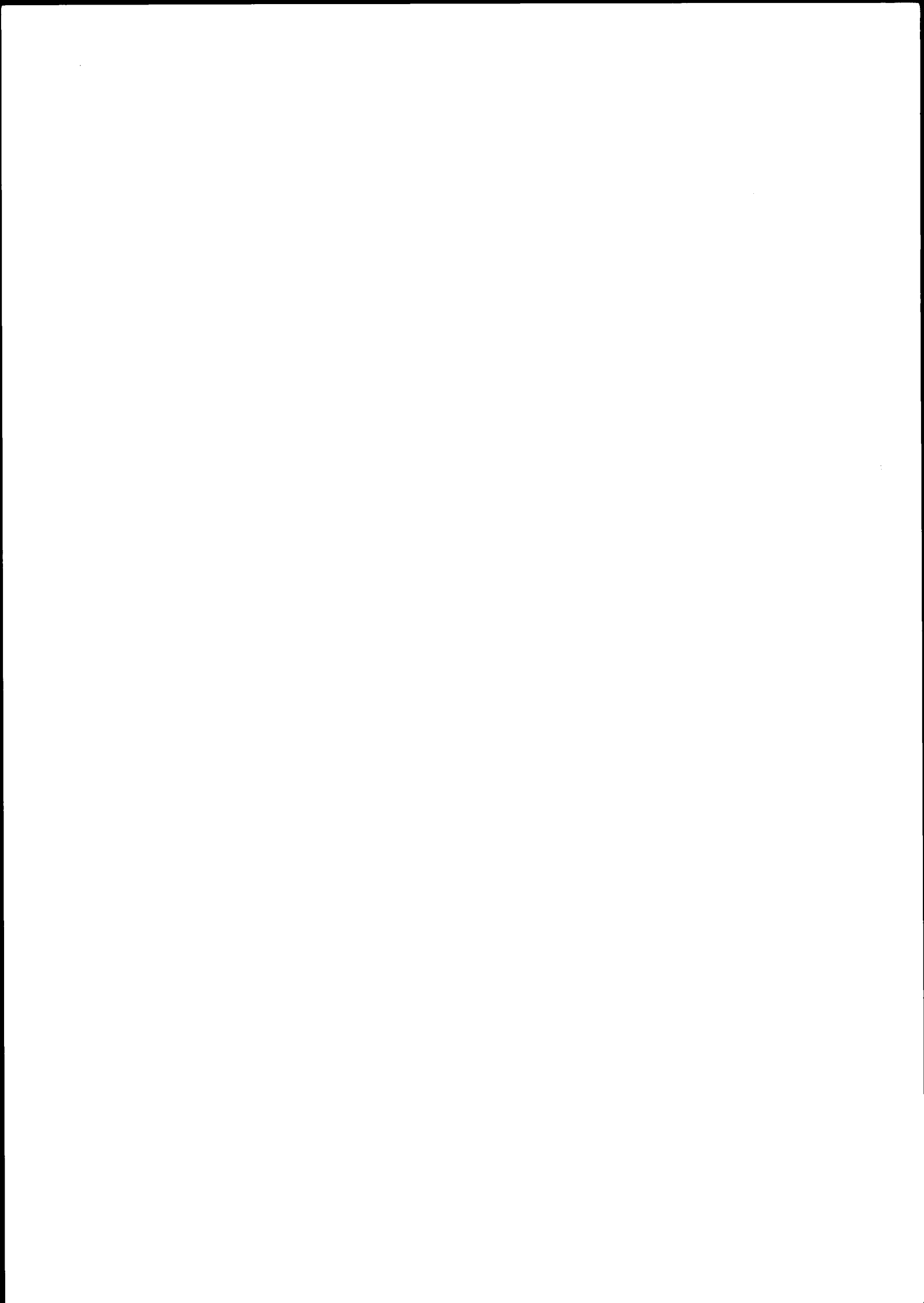

WLABo1d

TYPE 2
Stålvogner

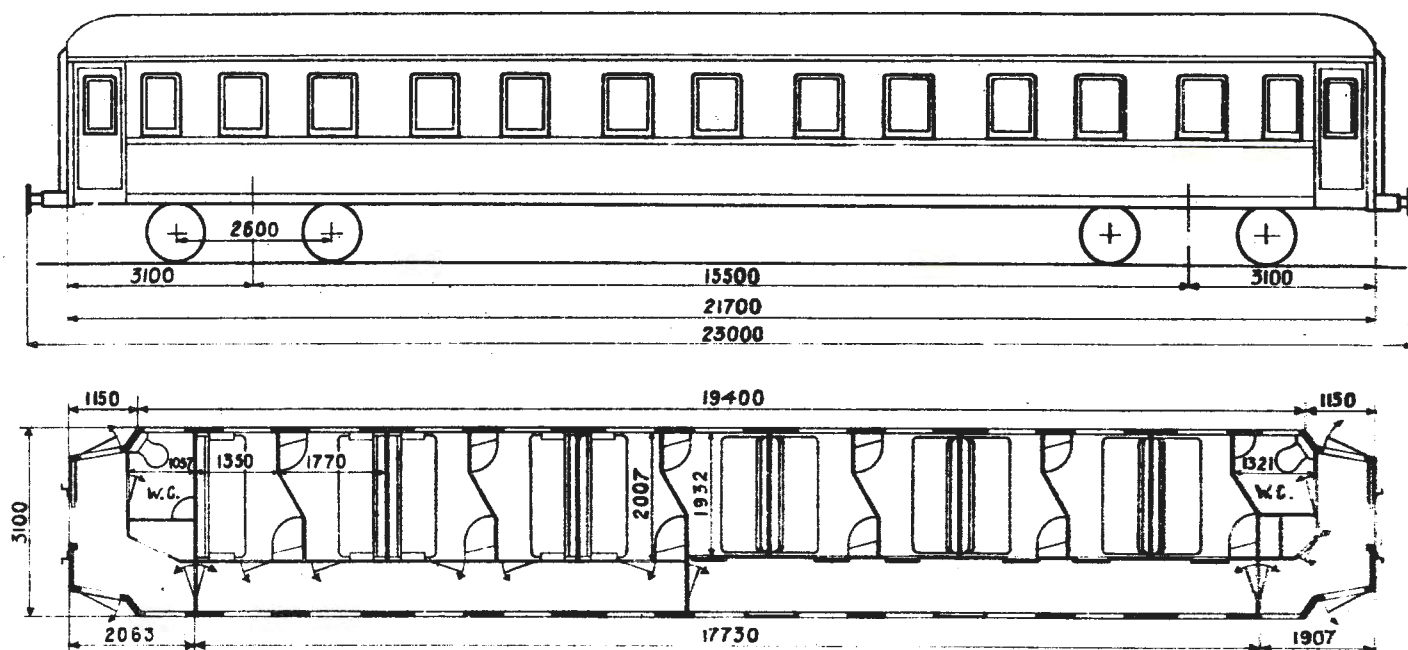

Hovedt. 5838

Vogn nr.	Distriktsmerke	Fabrikant	Byggeår	Omr. vognvekt i tonn	Sittepl. pr. vogn				Liggepl. pr. vogn	Grunnriss	El. varme i kW	Vognutstyr (se side 6)	Merknad
					1		2						
					klasse	klasse	klasse	klasse					
21016	D	Scd	52	39,5	15	24	10	18	51	1H.3.12.28.39ab			
21017	"	"	"	"	"	"	"	"	"	1H.3.12.28.39ab			
21018	"	"	"	"	"	"	"	"	"	1H.3.12.28.39ab			
21032	O	Skb	56	"	"	"	"	"	40	1H.3.12.28.39a			
21033	"	"	"	"	"	"	"	"	"	1H.3.12.28.39a			
21034	"	"	"	"	"	"	"	"	"	1H.3.12.28.39a			

WLBo1a

TYPE 1

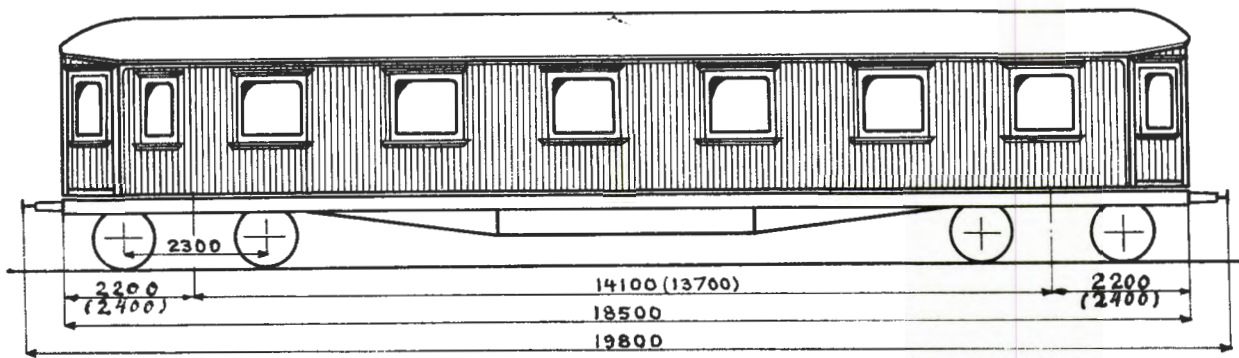

Mål i () for vogner efter tegn. 3140.

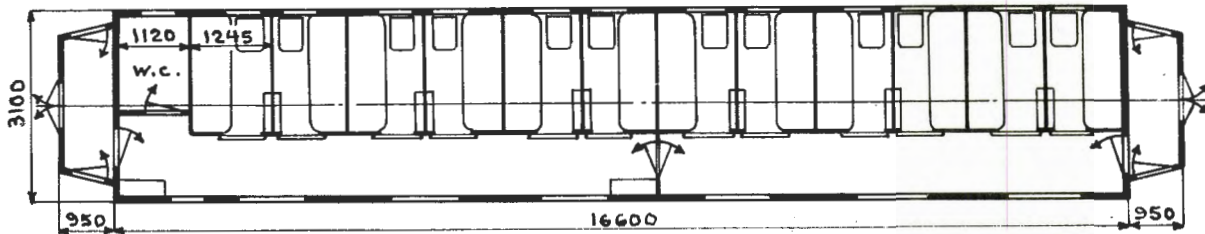

Hovedt. 1304
2249
3140

Vogn nr.	Distriktsmerke	Fabrikant	Byggeår	Omr. vognvægt i tonn	Sittepl. pr. vogn		Liggepl. pr. vogn		Grunnriss	El. varme i kW	Vognutstyr (se side 6)	Merknad
					1	2	1	2				
					klasse		klasse					
152	O	Str	20	36,5		48		36			1H.3.5.11.28.39a	2)
155	"	"	17	37,0		"		"			1KK.3.5.11.28.39a	2) Plattf.sidedører slår ut
158	"	"	14	36,5		"		"			1KK.3.5.11.28.39a	1) " " " "
159	"	"	"	"		"		"			1H.3.5.11.28.39a	1)
199	"	"	30	37,5		"		"			1KK.3.5.11.28.39a	3)
200	"	"	"	38,0		"		"			1H.3.5.11.28.39a	3)
579	D	"	20	36,5		"		"			1H.3.5.11.28.39a	2)
786	H	Kok	21	35,5		"		"			1KK.3.5.11.28.39a	2) Plattf.sidedører slår ut
890	O	Str	12	37,0		"		"			1KK.3.5.11.28.39a	1) " " " "
891	"	"	"	37,5		"		"			1KK.3.5.11.28.39a	1)
983	B	"	13	37,0		"		"			1H.3.5.11.28.39a	1)
984	"	"	"	35,5		"		"			1H.3.5.11.28.39a	1)
996	"	"	20	37,0		"		"			1H.3.5.11.28.39a	2)
18005	T	"	14	35,5		"		"			1H.3.5.11.28.39a	1)
18056	D	"	20	38,0		"		"			1H.3.5.11.28.39a	2) Plattf.sidedører slår ut
18063	"	"	"	37,0		"		"			1H.3.5.11.28.39a	2)
18102	T	Kok	21	36,5		"		"			1H.3.5.11.28.39a	2)
18103	"	"	"	"		"		"			1H.3.5.11.28.39a	2)
18116	B	Skb	25	37,0		"		"			1H.3.5.11.28.39a	2)
18117	"	"	"	"		"		"			1H.3.5.11.28.39a	2)

1) Hovedt. 1304
2) " 2249
3) " 3140

Trykk nr. 751 1.7.57

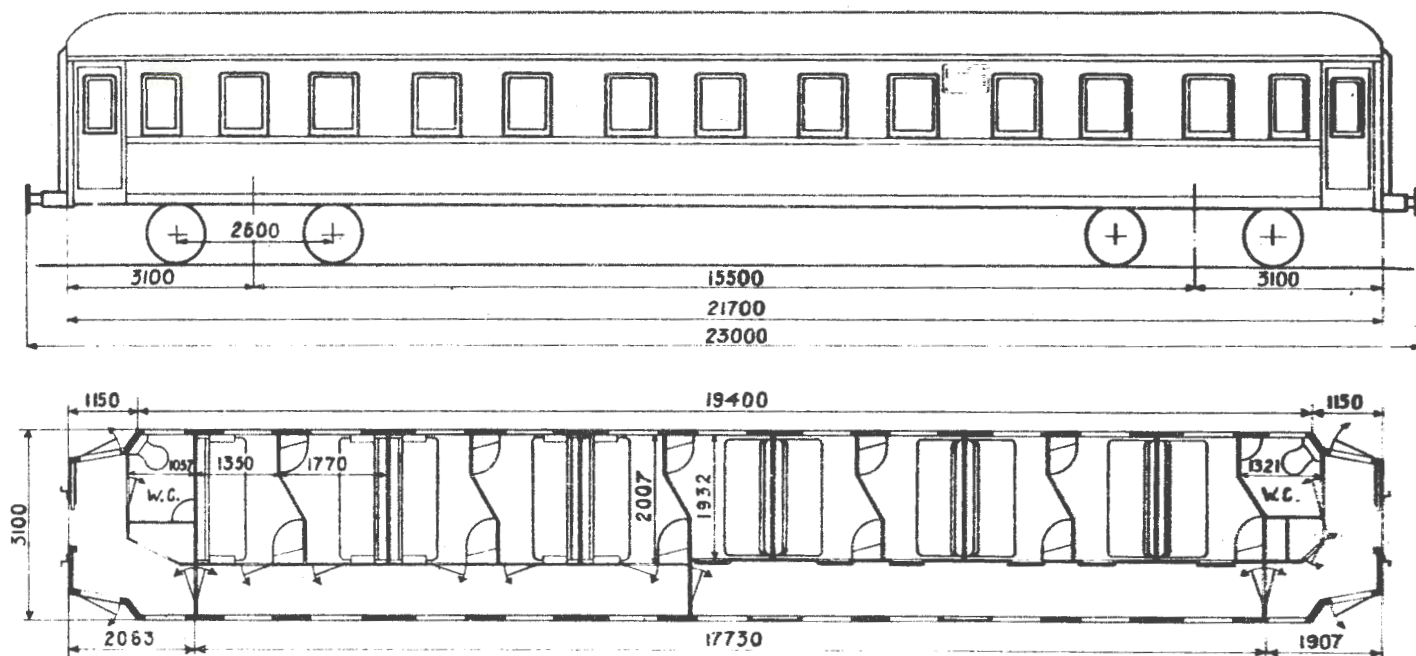

Hovedt. 5838

Vogn nr.	Distriktsmerke	Fabrikant	Byggeår	Omr. vognvekt i tonn	Sittepl. pr. vogn				Liggepl. pr. vogn		Grunnriss	El.varme i kW	Vognutstyr (se side 6)	Merknad		
					1		2		1						2	
					klasse		klasse		klasse						klasse	
21016	D	Scd	52	39,5	15	24	10	18	51	1H.3.12.28.39ab						
21017	"	"	"	"	"	"	"	"	"	1H.3.12.28.39ab						
21018	"	"	"	"	"	"	"	"	"	1H.3.12.28.39ab						
21032	O	Skb	56	"	"	"	"	"	40	1H.3.12.28.39a						
21033	"	"	"	40,0	"	"	"	"	"	1H.3.12.28.39a						
21034	"	"	"	"	"	"	"	"	"	1H.3.12.28.39a						

WLBo1a

TYPE 1

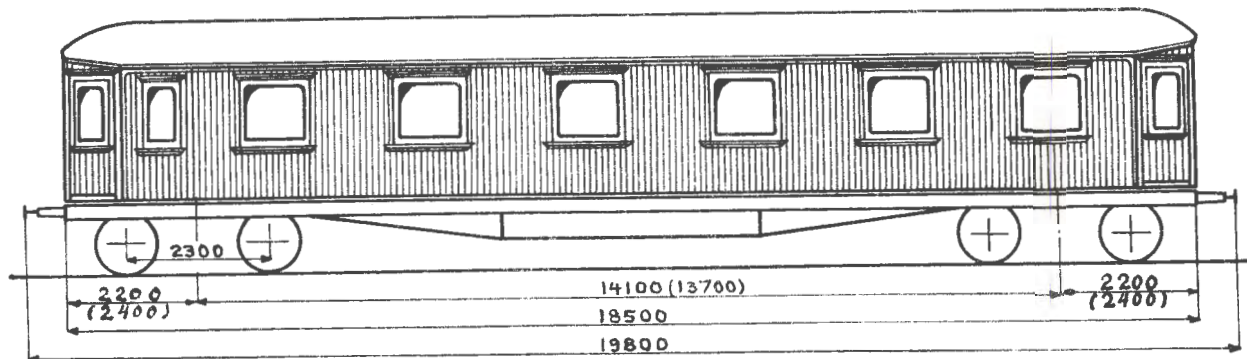

Mål i () för vagnar efter teqn. 3140.

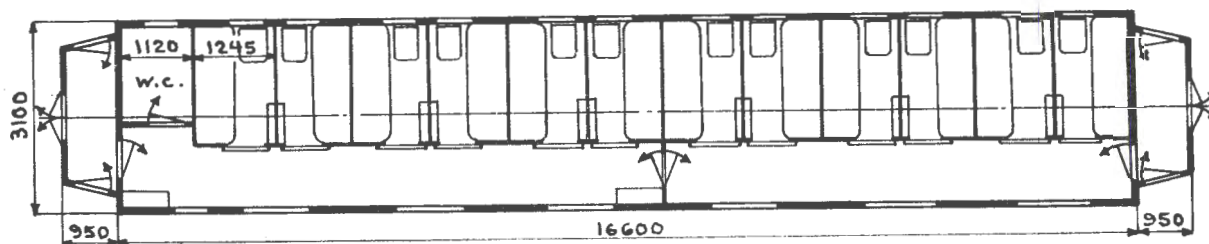

Hovedt. 1304
2249
3140

Vogn nr.	Distriktsmerke	Fabrikant	Byggeår	Omr. vognvekt i tonn	Sittepl. pr. vogn		Liggepl. pr. vogn		Grunnriss	El. varme i kW	Vognutstyr (se side 6)	Merknad
					1	2	1	2				
152	0	Str	20	37,0		48		36			1H.3.5.11.28.39a	2)
155	"	"	17	"		"		"			1KK.3.5.11.28.39a	2) Plattf.sidedörer slår ut
158	"	"	14	36,5		"		"			1KK.3.5.11.28.39a	1) " " " "
159	"	"	"	"		"		"			1H.3.5.11.28.39a	1)
199	"	"	30	37,0		"		"			1KK.3.5.11.28.39a	3)
200	"	"	"	38,0		"		"			1H.3.5.11.28.39a	3)
579	D	"	20	36,5		"		"			1H.3.5.11.28.39a	2)
786	H	Kok	21	35,5		"		"			1KK.3.5.11.28.39a	2) Plattf.sidedörer slår ut
890	0	Str	12	36,0		"		"			1KK.3.5.11.28.39a	1) " " " "
891	"	"	"	37,5		"		"			1KK.3.5.11.28.39a	1)
983	B	"	13	37,0		"		"			1H.3.5.11.28.39a	1)
984	"	"	"	35,5		"		"			1H.3.5.11.28.39a	1)
996	"	"	20	37,0		"		"			1H.3.5.11.28.39a	2)
18005	T	"	14	35,5		"		"			1H.3.5.11.28.39a	1)
18056	D	"	20	38,0		"		"			1H.3.5.11.28.39a	2) Plattf.sidedörer slår ut
18063	"	"	"	37,0		"		"			1H.3.5.11.28.39a	2)
18102	T	Kok	21	36,5		"		"			1H.3.5.11.28.39a	2)
18103	"	"	"	"		"		"			1H.3.5.11.28.39a	2)
18116	B	Skb	25	37,0		"		"			1H.3.5.11.28.39a	2)
18117	"	"	"	"		"		"			1H.3.5.11.28.39a	2)

1) Hovedt. 1304
2) " 2249
3) " 3140

Trykk nr. 751 1.7.58

WLBo1b

TYPE 1

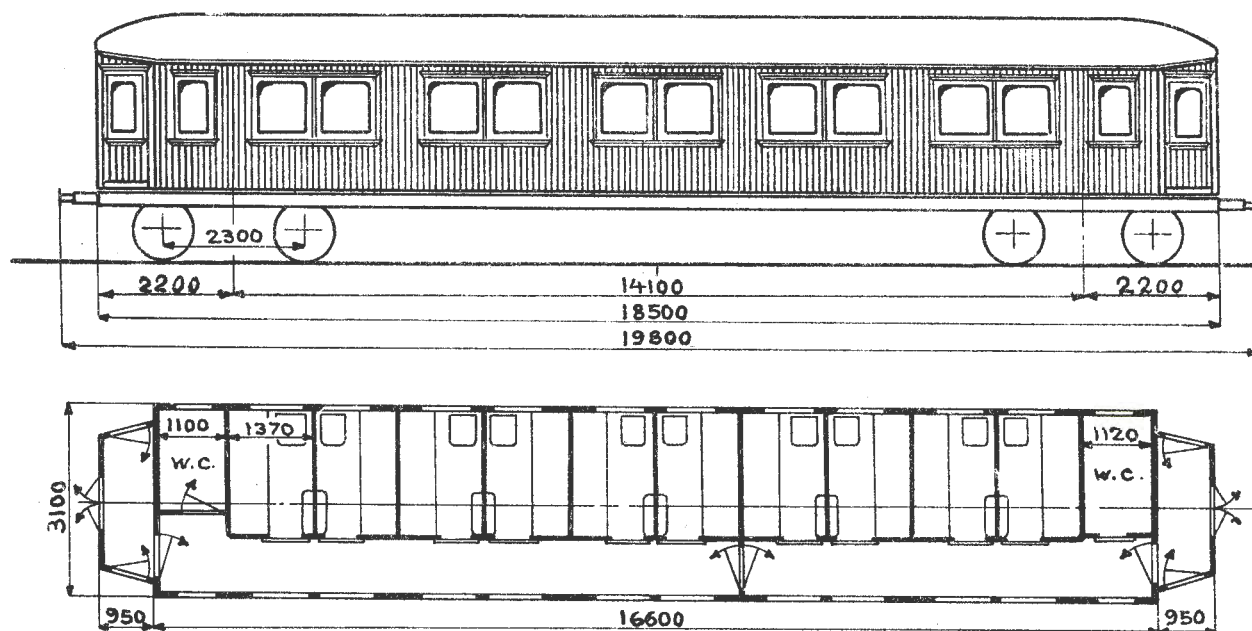

Hovedt. 2059¹⁾
2222¹⁾

Vogn nr.	Distriktsmerke	Fabrikant	Byggeår	Omr. vognvekt i tonn	Sittepl. Liggepl. pr. vogn				Grunnriss	El.varme i kW	Vognutstyr (se side 6)	Merknad
					1		2					
					klasse	klasse	klasse	klasse				
18003	O	Skb	14	36,5		40		30		1H.3.5.11.28.39a	Hovedt. 2059	
18048	T	"	17	37,5		"		"	1H.3.5.11.28.39a			
18050	"	"	"	"		"		"	1H.3.5.11.28.39a			
113	O	"	19	36,0		"		"	1KK.3.5.11.28.39a			
102	D	Kok	21	35,5		"		"	1KK.3.5.11.28.35.39a			

1) Forandr. etter tegn. 4384

WLB01c

TYPE 1

Stålvogner

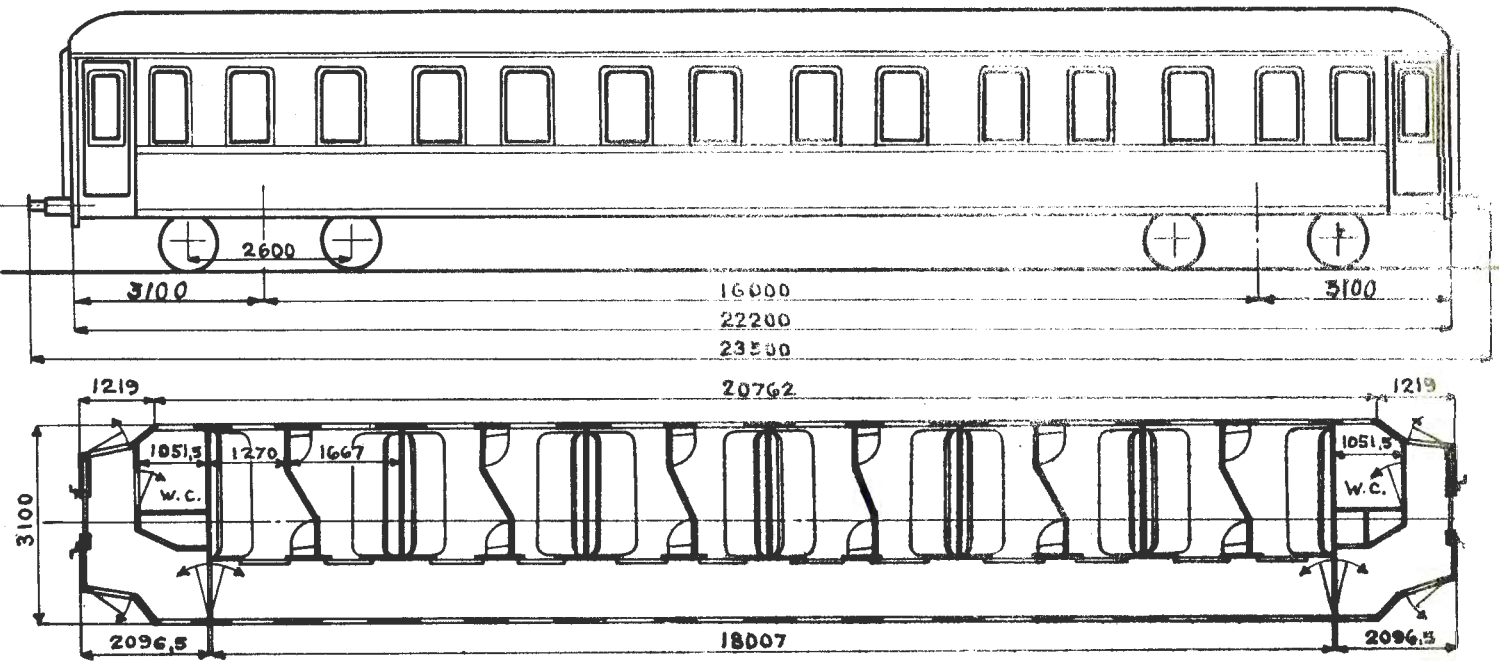

Hovedt. 4700

Vogn nr.	Distriktsmerke	Fabrikant	Byggeår	Omr. vognvekt i tonn	Sittepl. pr. vogn				Liggepl. pr. vogn	Grunnriss	El. varme i kW	Vognutstyr (se side 6)	Merknad
					1		2						
					klasse	klasse	klasse	klasse					
21007	0	Skb	41	38,0		48		36	45	1H.3.5.11.28.39b			
21008	"	"	"	39,0		"		"	"	1H.3.5.11.28.39b			
21009	"	"	"	"		"		"	"	1H.3.5.11.28.39b			

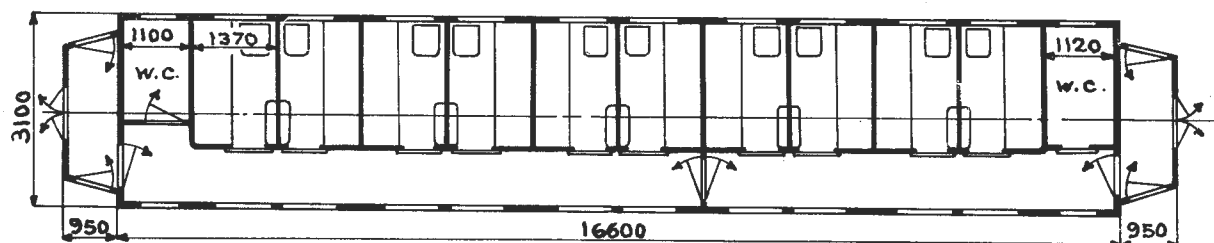
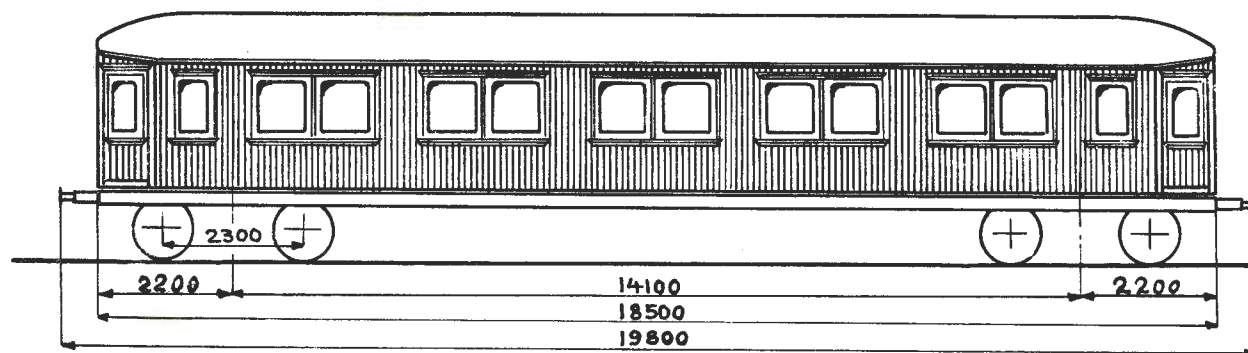

Hovedt. 2059¹⁾
2222¹⁾

Vogn nr	Distriktsmerke	Fabrikant	Byggeår	Omtr. vognvekt i tonn	Sittepl. pr. vogn		Liggepl. pr. vogn		Grunnriss	El. varme i kW	Vognutstyr (se side 6)	Merknad
					1	2	1	2				
					klasse		klasse					
102	D	Kok	21	36,5		40		30			1KK.3.5.11.28.39a	Hovedt. 2059
113	O	Skb	19	36,0		"		"			1KK.3.5.11.28.39a	
18003	"	"	14	36,5		"		"			1H.3.5.11.28.39a	
18048	T	"	17	37,5		"		"			1H.3.5.11.28.39a	
18050	"	"	"	"		"		"			1H.3.5.11.28.39a	

1) Forandr. etter tegn. 4384
Trykk nr. 751 1.7.57

WLB01c

TYPE 1

Stålvogner

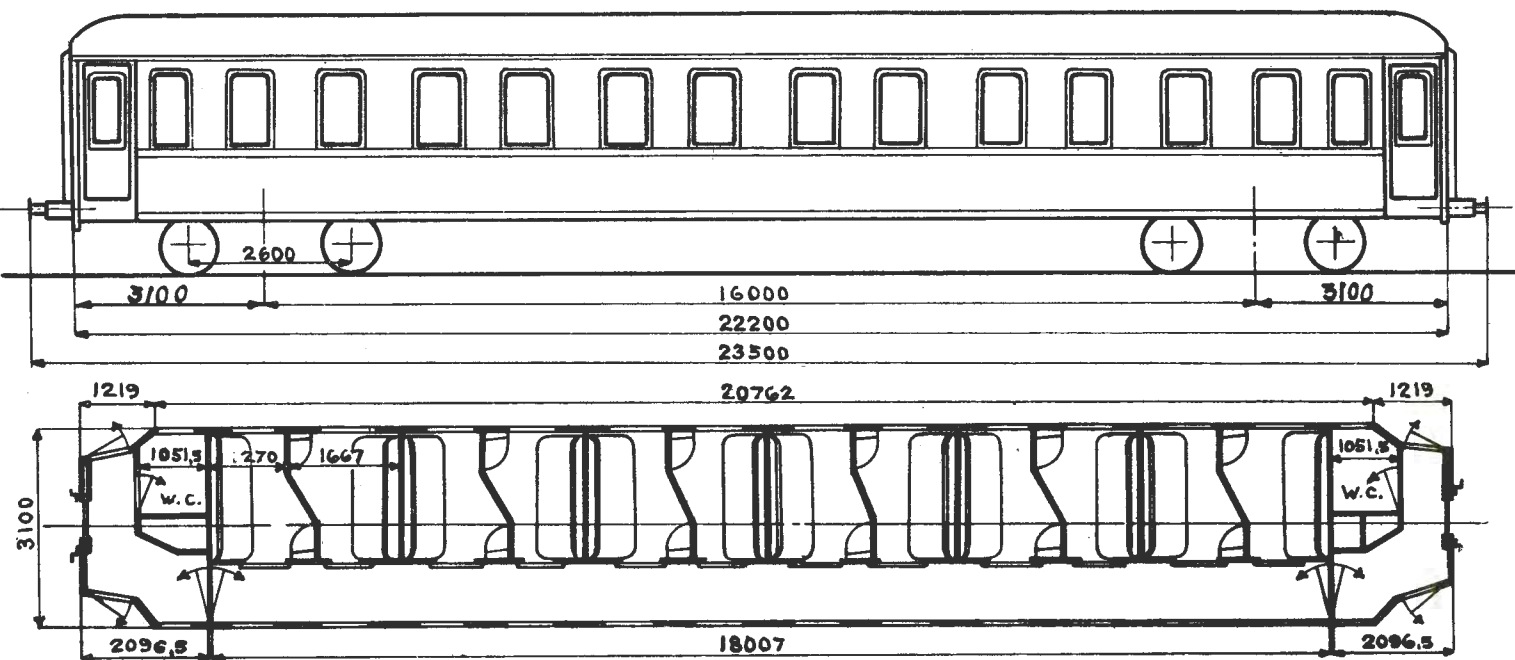

Hovedt. 4700

Vogn nr.	Distriktsmerke	Fabrikant	Byggeår	Omr. vognvekt i tonn	Sittepl. pr. vogn				Liggepl. pr. vogn	Grunnriss	El. varme i kW	Vognutstyr (se side 6)	Merknad
					1		2						
					klasse	klasse	klasse	klasse					
21007	0	Skb	41	38,0		48		36		45	1H.3.5.11.28.39b		
21008	"	"	"	39,0		"		"		"	1H.3.5.11.28.39b		
21009	"	"	"	"		"		"		"	1H.3.5.11.28.39b		

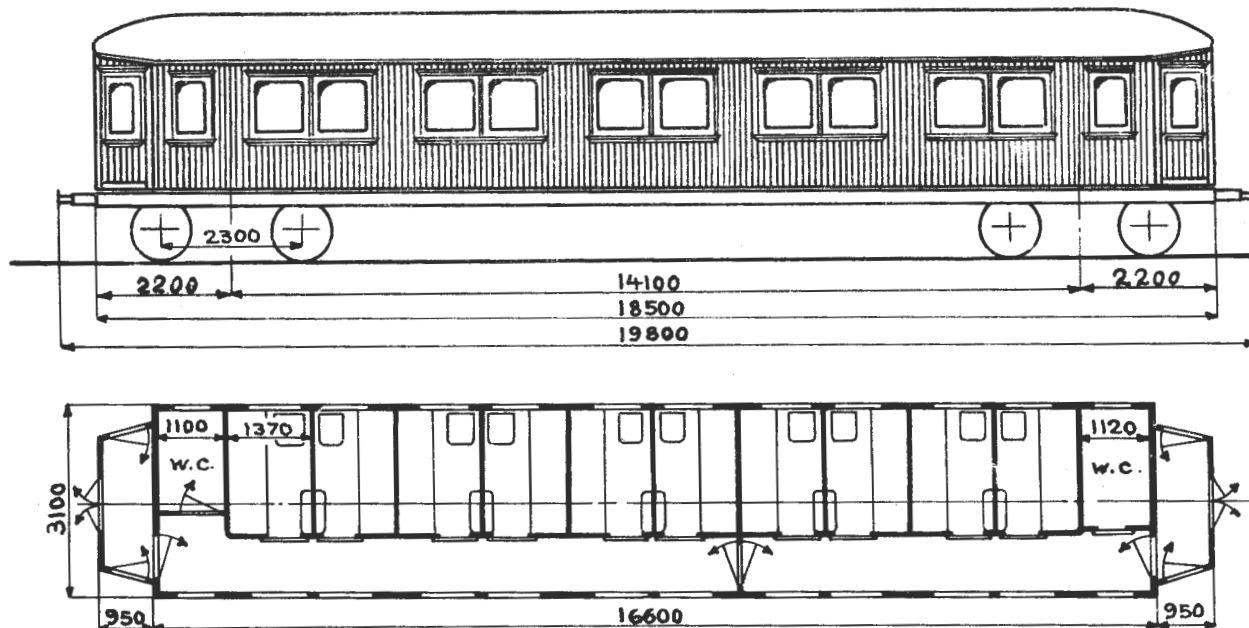

Hovedt. 2059¹⁾
2222¹⁾

Vogn nr	Distriktsmerke	Fabrikant	Byggear	Omtr. vognvekt i tonn	Sittepl. pr. vogn		Liggepl. pr. vogn		Grunnriss	El. varme i kW	Vognutstyr (se side 6)	Merknad
					1	2	1	2				
					klasse		klasse					
102	D	Kok	21	36,5		40		30			1KK.3.5.11.28.39a	Hovedt. 2059
113	O	Skb	19	36,0		"		"		1KK.3.5.11.28.39a		
18003	"	"	14	36,5		"		"		1H.3.5.11.28.39a		
18048	T	"	17	37,5		"		"		1H.3.5.11.28.39a		
18050	"	"	"	"		"		"		1H.3.5.11.28.39a		

1) Forandr. etter tegn. 4384
Trykk nr. 751 1.7.57

WLBo1c

TYPE 1

Stålvogner

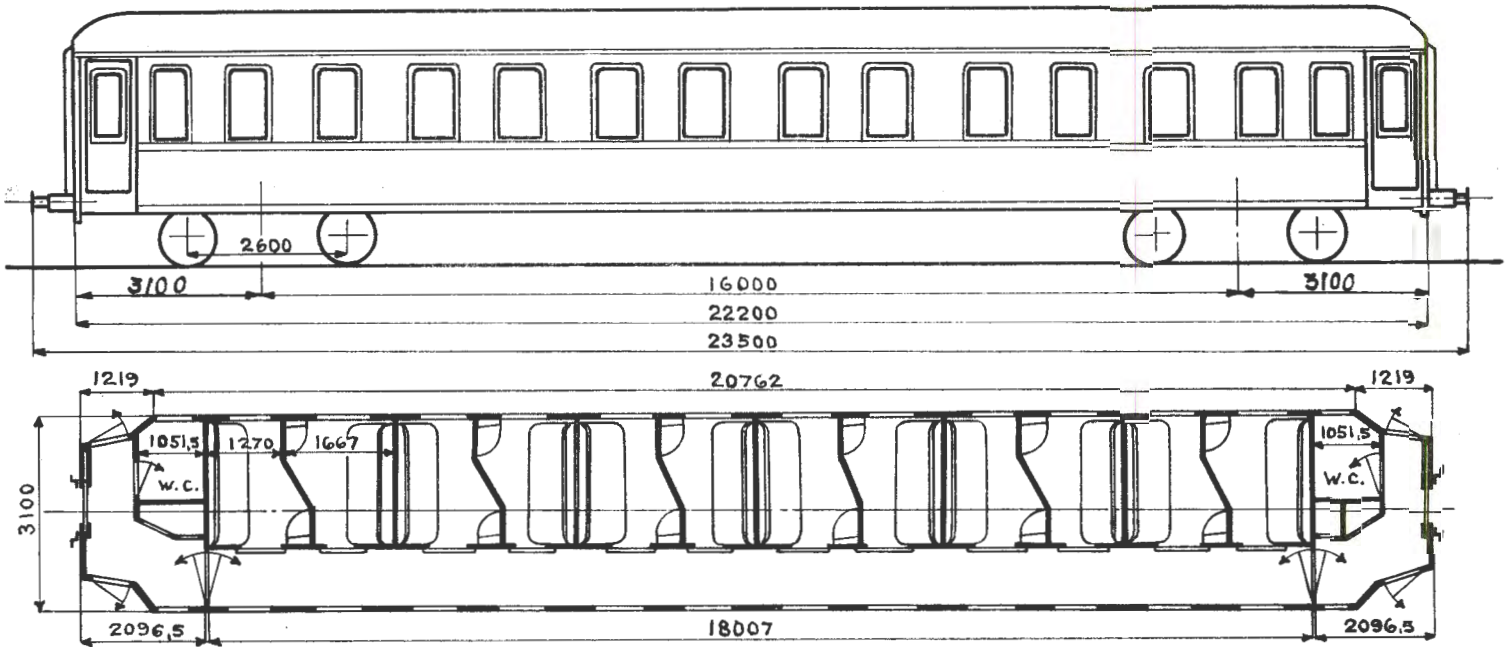

Hovedt. 4700

Vogn nr.	Distriktsmerke	Fabrikant	Byggeår	Omr. vognvekt i tonn	Sittepl. pr. vogn		Liggepl. pr. vogn		Grunnriss	El. varme i kW	Vognutstyr (se side 6)	Merknad
					1	2	1	2				
					klasse		klasse					
21007	0	Skb	41	38,0	48		36		45	1H.3.5.11.28.39b		
21008	"	"	"	39,0	"		"		"	1H.3.5.11.28.39b		
21009	"	"	"	"	"		"		"	1H.3.5.12.28.39b		

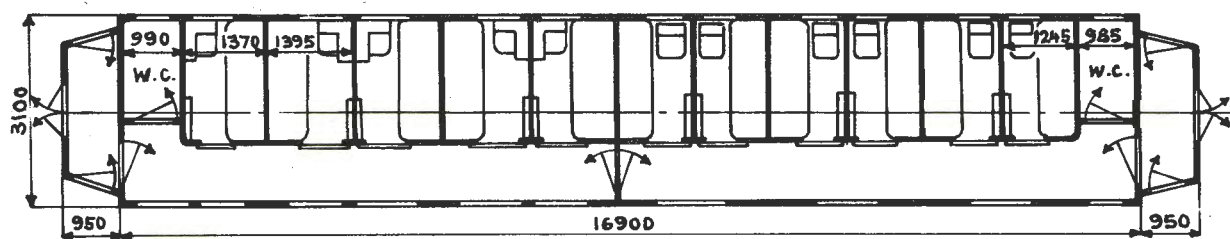
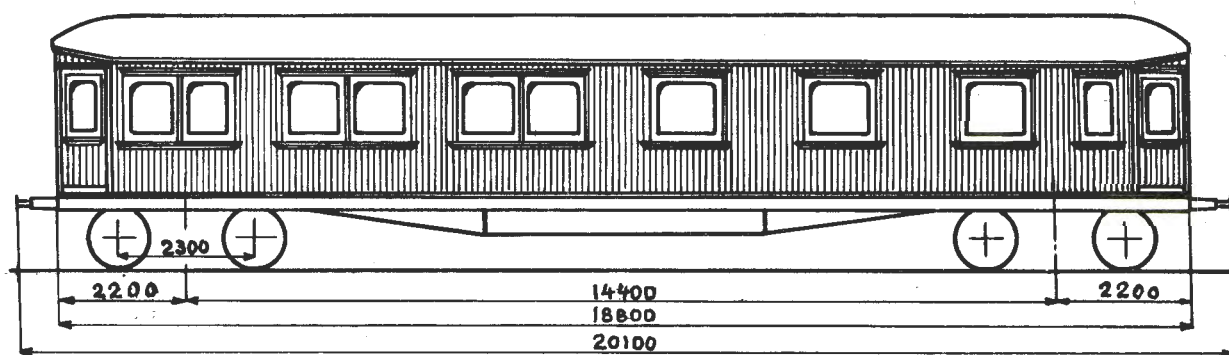

Oppr. hovedt. 2541¹⁾

Vogn nr.	Distriktsmerke	Fabrikant	Byggeår	Omtr. vognvekt i tonn	Sittepl. pr. vogn		Liggepl. pr. vogn		Grunnriss	El.varme i kW	Vognutstyr (se side 6)	Merknad
					1	2	1	2				
					klasse		klasse					
18114	D	Skb	25	36,5		44		33			1KK.3.5.11.28.39a	
18115	"	"	"	34,0		"		"			1KK.3.5.10.28.39a	

1) Forandr. etter Brg d. skisse dat. 14.8.41
Trykk nr. 751 1.7.56

WLBo1d

TYPE 2
Stålvogner

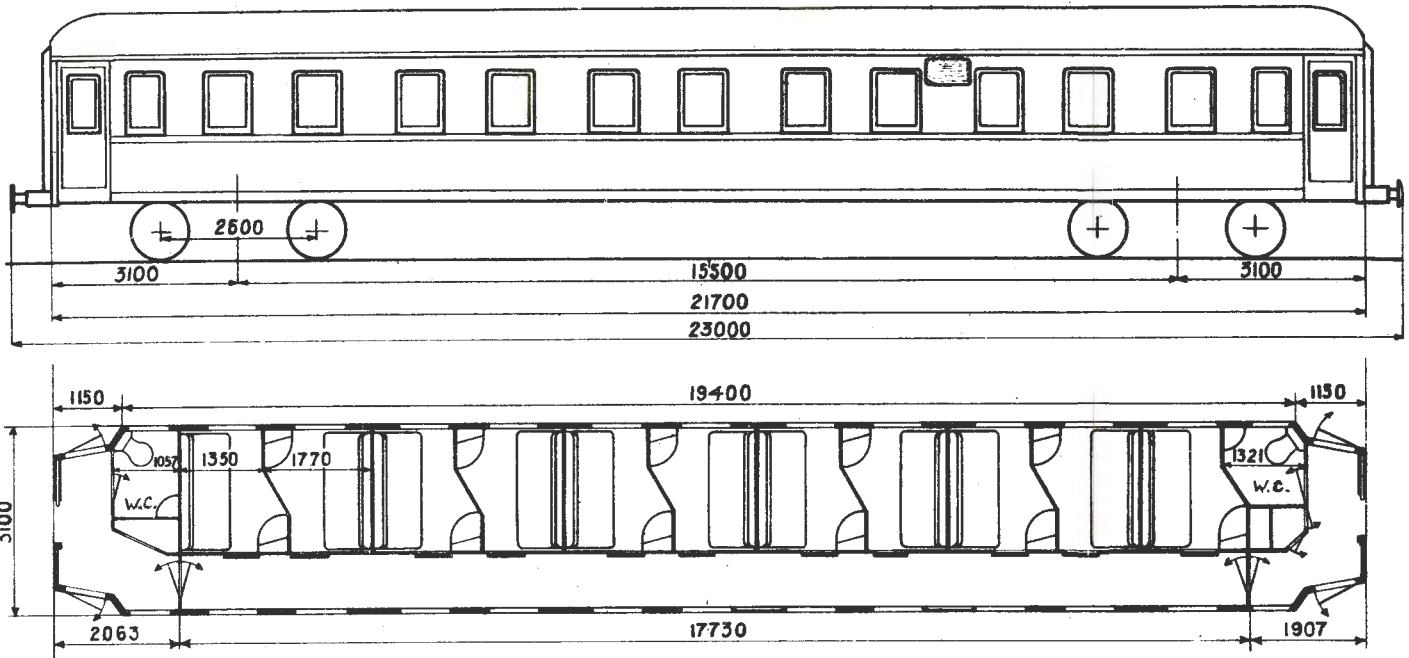

Hovedt. 5836

Vogn nr.	Distriktsmerke	Fabrikant	Byggeår	Omr. vognvekt i tonn	Sittepl. pr. vogn		Liggepl. pr. vogn		Grunnriss	El.varme i kW	Vognutstyr (se side 6)	Merknad
					1	2	1	2				
					klasse		klasse					
21019	D	Scd	51	40,0		44		33	51	1H.3.12.28.39ab		
21020	"	"	"	40,5		"		"	"	1H.3.12.28.39ab		
21021	"	"	"	40,0		"		"	"	1H.3.12.28.39ab		
21022	"	"	"	"		"		"	"	1H.3.12.28.39ab		
21023	0	"	"	"		"		"	"	1H.3.12.28.39ab		
21024	"	"	"	40,5		"		"	"	1H.3.12.28.39ab		
21025	B	Skb	56	"		"		"	30	1H.3.5.11.28.39a		
21026	"	"	"	"		"		"	"	1H.3.5.11.28.39a		
21027	"	"	"	"		"		"	"	1H.3.5.11.28.39a		
21028	"	"	57	"		"		"	"	1H.3.5.11.28.39a		
21029	0	"	"	"		"		"	"	1H.3.5.11.28.39a		
21030	T	"	"	"		"		"	"	1H.3.5.11.28.39a		
21031	"	"	"	"		"		"	"	1H.3.5.11.28.39a		

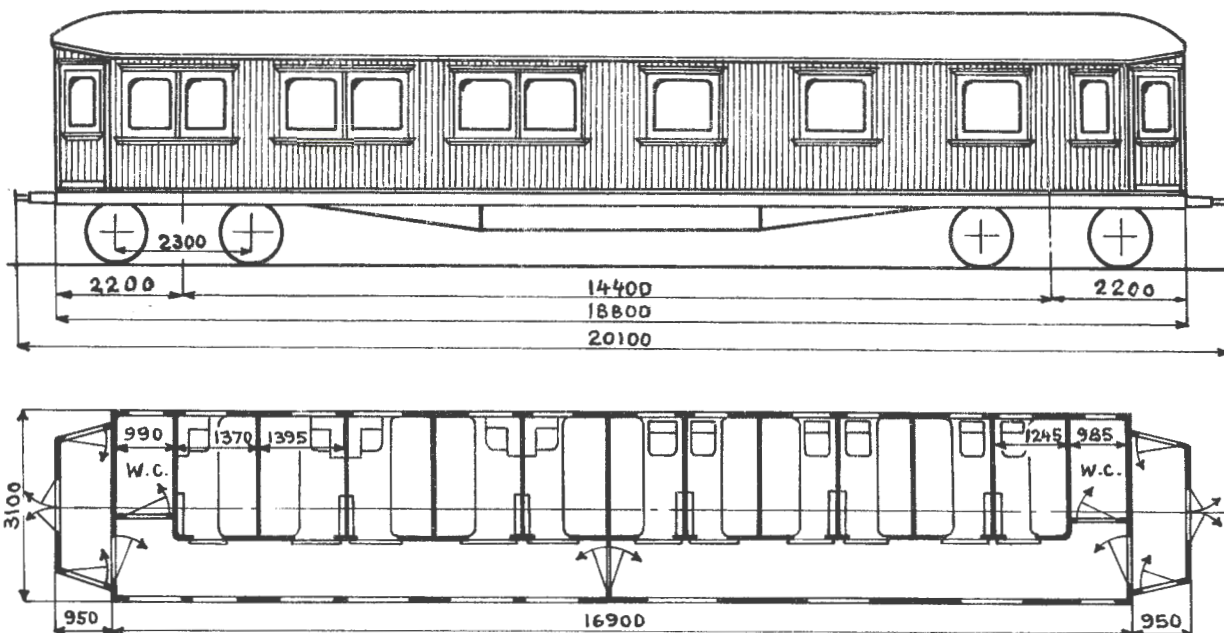

Oppr. hovedt. 2541¹⁾

Vogn nr	Distriktsmerke	Fabrikant	Byggeår	Omr. vognvekt i tonn	Sittepl. pr vogn		Liggepl. pr vogn		Grunnriss	El. varme i kW	Vognutstyr (se side 6)	Merknad
					1	2	1	2				
18114	D	Skb	25	36,5	44		33				1KK.3.5.11.28.39a	
18115	"	"	"	37,0	"		"				1H.3.5.11.28.39a	

1) Forandr. etter Brg d. skisse dat. 14.8.41

WLBo1d

TYPE 2
Stålvogner

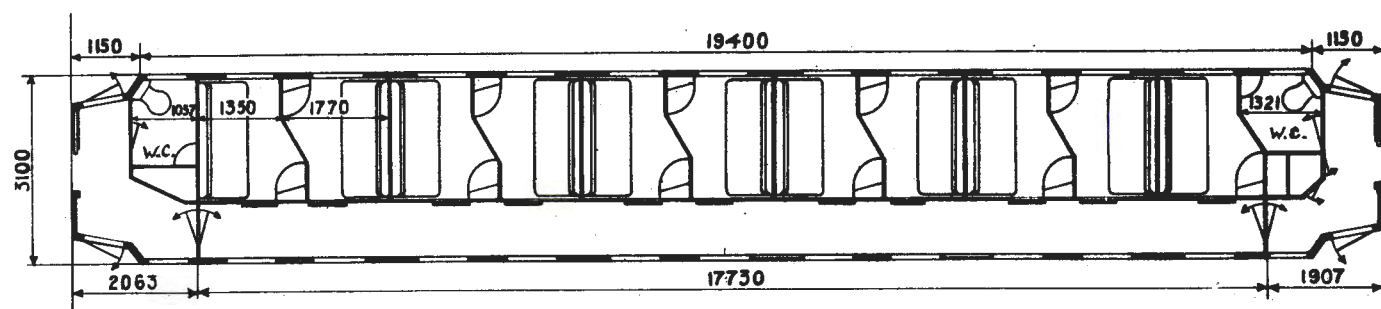
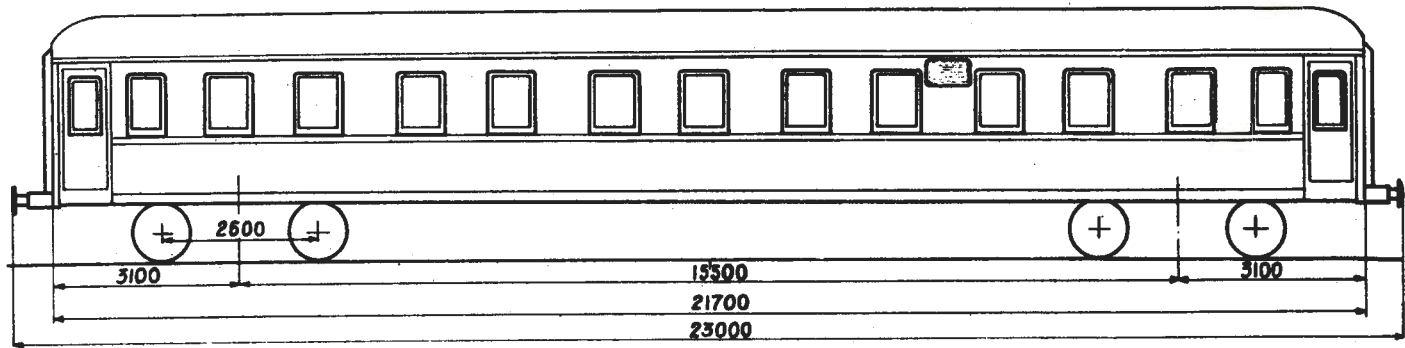

Hovedt. 5836

Vogn nr.	Distriktsmerke	Fabrikant	Byggeår	Omr. vognvekt i tonn	Sittpl. pr. vogn		Liggepl. pr. vogn		Grunnriss	El. varme i kW	Vognutstyr (se side 6)	Merknad
					1	2	1	2				
					klasse		klasse					
21019	D	Scd	51	40,0		44		33	51	1H.3.12.28.39ab		
21020	"	"	"	40,5		"		"	"	1H.3.12.28.39ab		
21021	"	"	"	40,0		"		"	"	1H.3.12.28.39ab		
21022	"	"	"	"		"		"	"	1H.3.12.28.39ab		
21023	O	"	"	"		"		"	"	1H.3.12.28.39ab		
21024	"	"	"	40,5		"		"	"	1H.3.12.28.39ab		
21025	B	Skb	56	"		"		"	30	1H.3.5.11.28.39a		
21026	"	"	"	"		"		"	"	1H.3.5.11.28.39a		
21027	"	"	"	"		"		"	"	1H.3.5.11.28.39a		
21028	"	"	57	"		"		"	"	1H.3.5.11.28.39a		
21029	O	"	"	"		"		"	"	1H.3.5.11.28.39a		
21030	T	"	"	"		"		"	"	1H.3.5.11.28.39a		
21031	"	"	"	"		"		"	"	1H.3.5.11.28.39a		

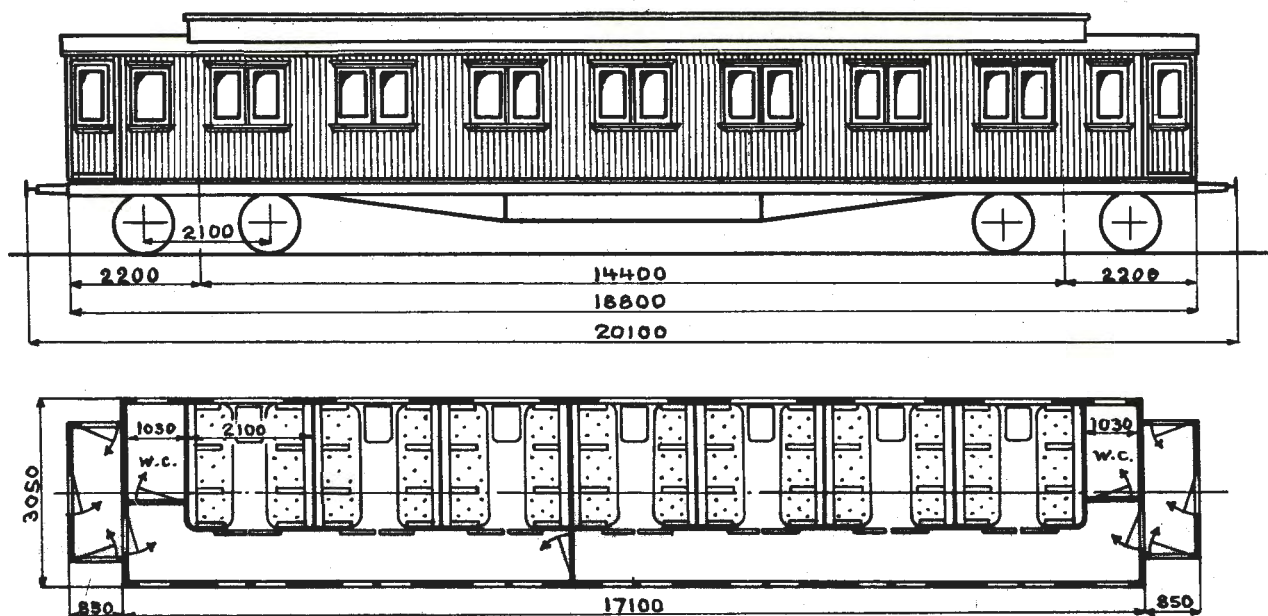

Oppr. hovedt. 700¹⁾

Vogn nr.	Distriktsmerke	Fabrikant	Byggeår	Omr. vognvekt i tonn	Sittepl. 1.klasse	Grunnriss	El. varme i kW	Vognutstyr (se side 6)	Merknad
951	B	Skb	04	30,5	42			1H.3.5.11.28.39a	
952	"	"	"	30,0	"			1H.3.5.11.28.39a	
953	"	"	"	30,5	"			1H.3.5.11.28	

1) Forandr. etter tegn. Bg. 1258
Trykk nr. 751 1.7.57

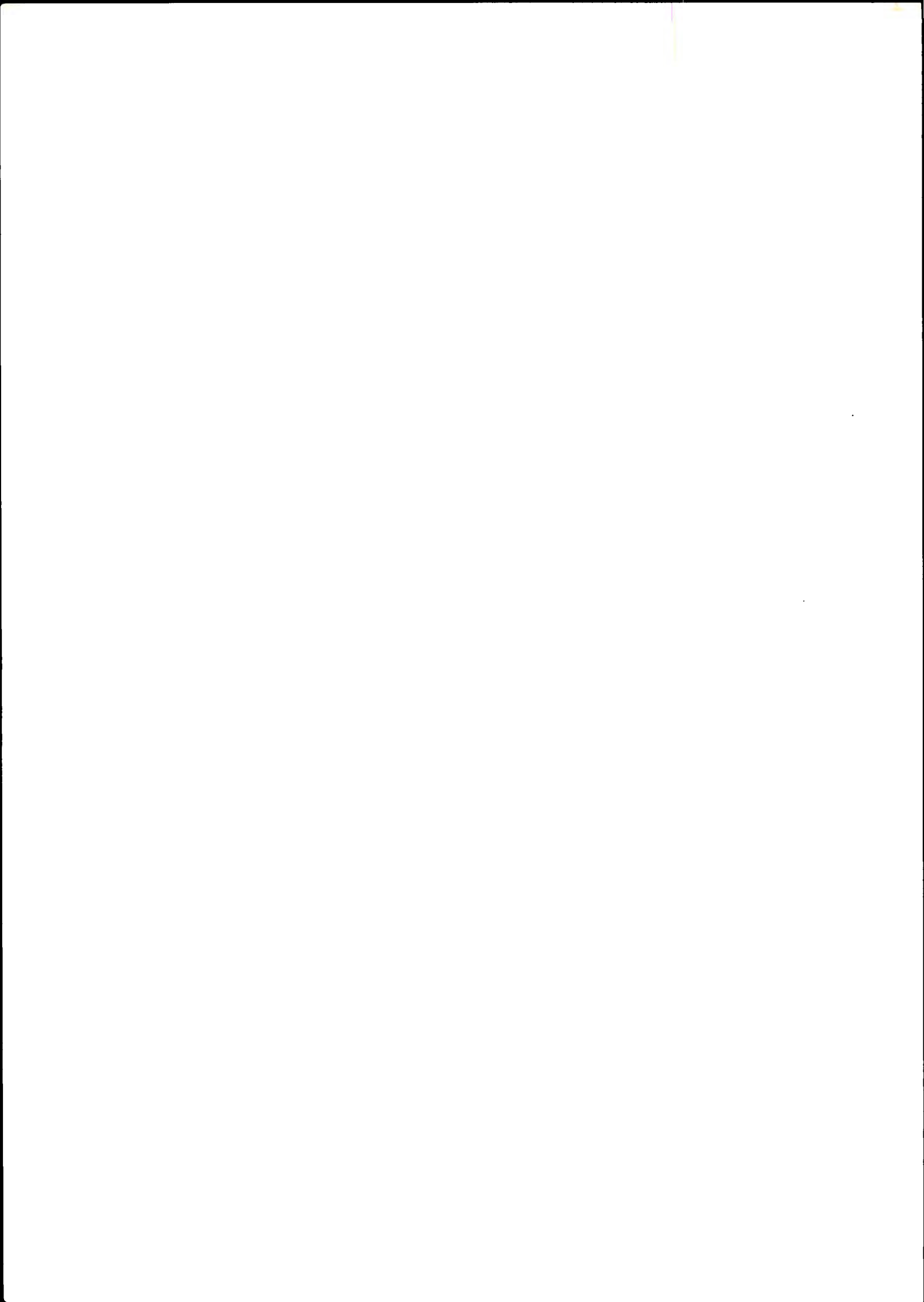

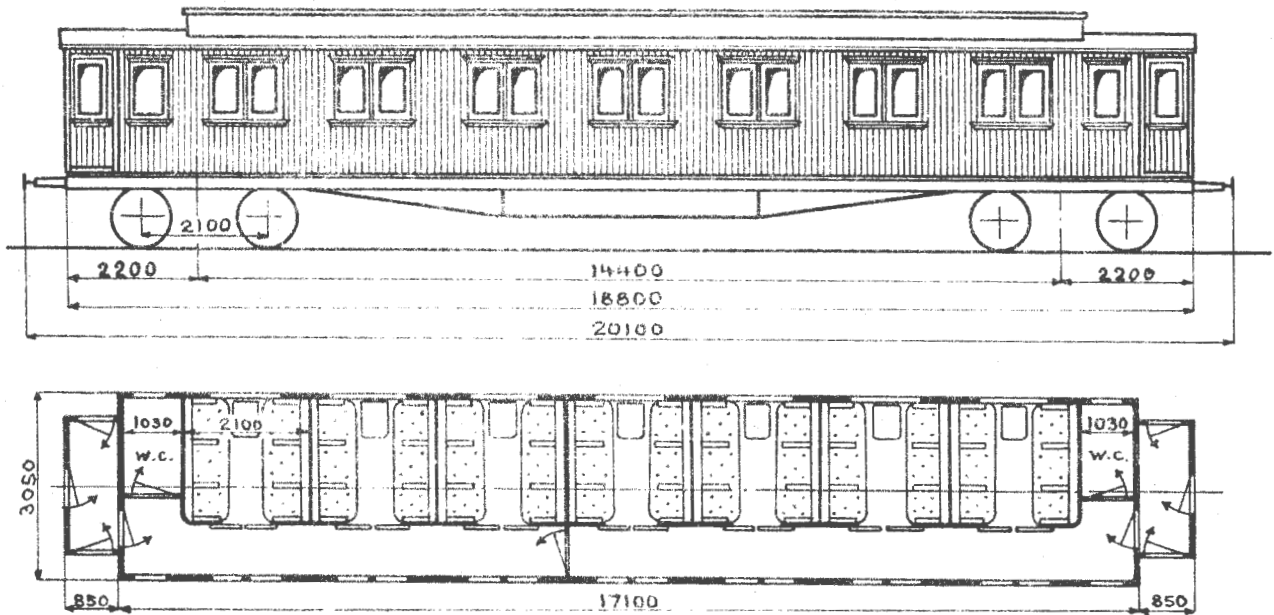

Oppr. hovedt. 700¹⁾

Vogn nr.	Distriktsmerke	Fabrikant	Byggeår	Omr. vognvekt i tonn	Sittepl. 1.klasse	Grunnmiss	El.varme i kW	Vognutstyr (se side 6)	Merknad
951	B	Skb	04	30,5	42			1H.3.5.11.28.39a	
952	"	"	"	30,0	"			1H.3.5.11.28.39a	

1) Forandr. etter tegn. Bg. 1258
Trykk nr. 751 1.7.58

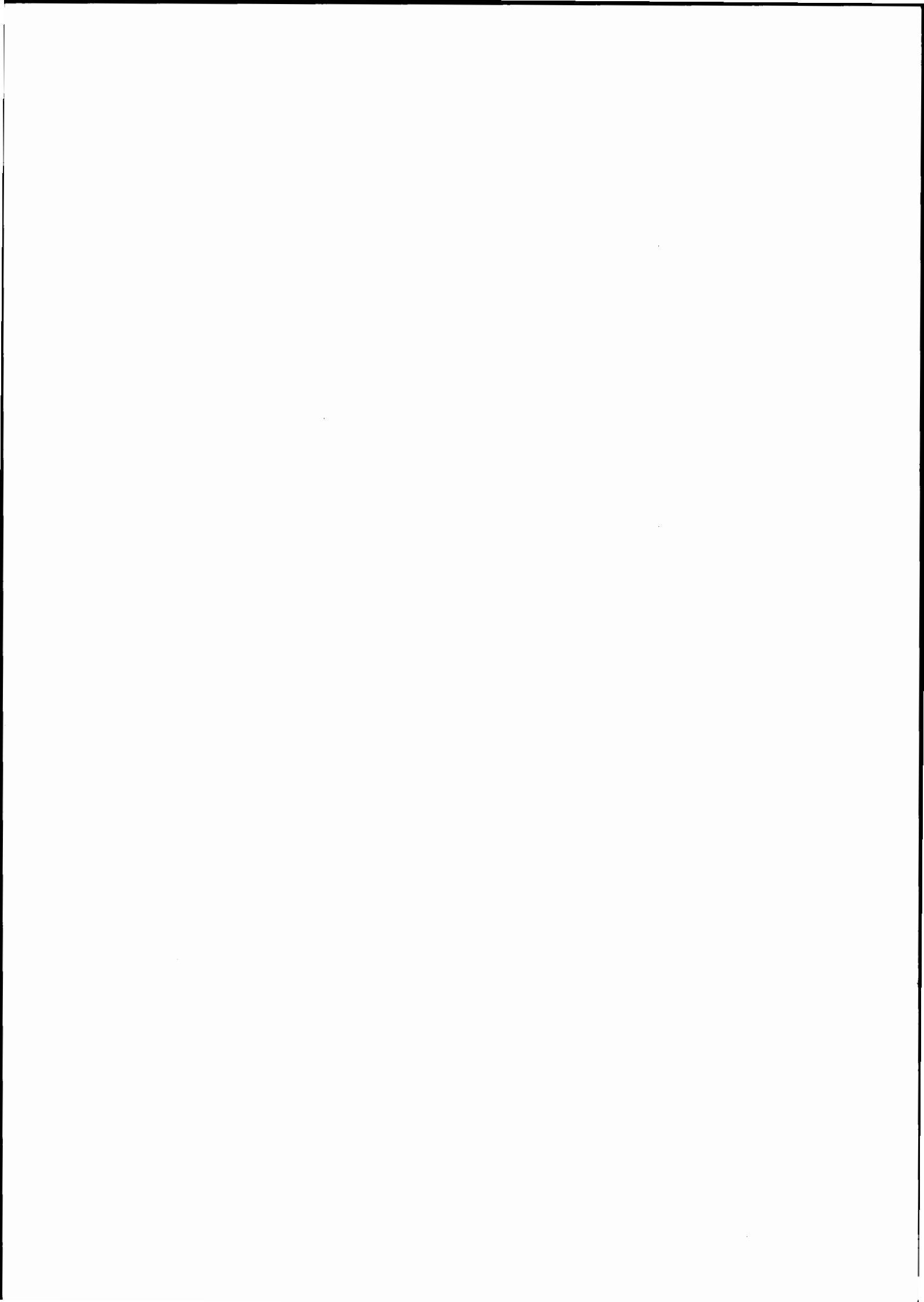

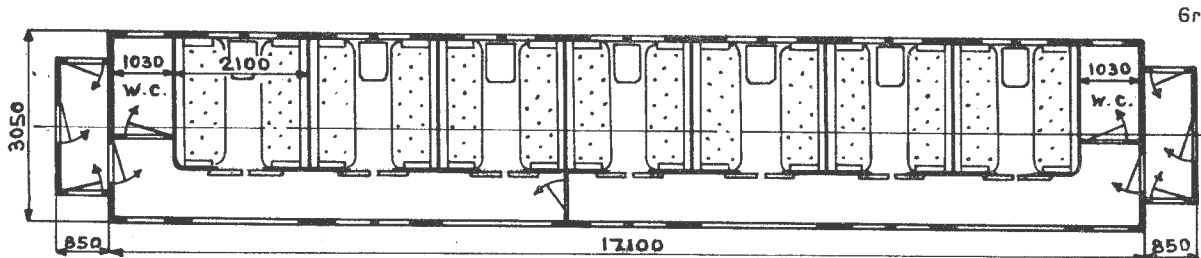
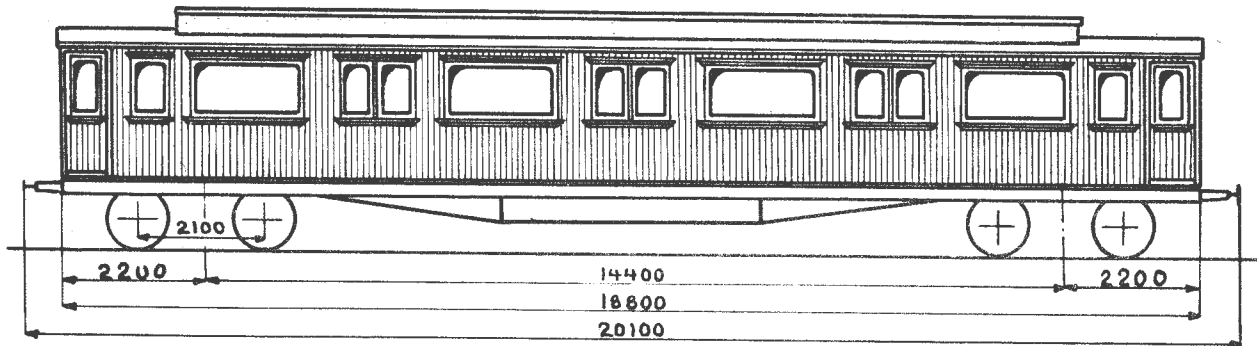

Grunnriss 1

Hovedt.
700
+958

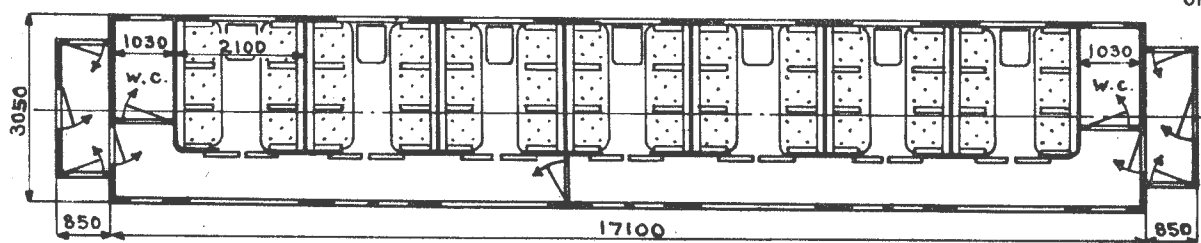

Grunnriss 2

Hovedt.
700
+958

Vogn nr.	Distriktsmerke	Fabrikant	Byggeår	Omr. vognvekt i tonn	Sittepl. 1.klasse	Grunnriss	El. varme i kW	Vognutstyr (se side 6)	Merknad
501	D	Skb	09	30,0	42	2		1H.3.5.12.28.39a	
502	"	"	"	31,5	"	1		1H.3.5.11.28.39a	
930	B	"	"	29,0	"	2		1H.3.5.11.28.39a	

Ao2b

TYPE 1

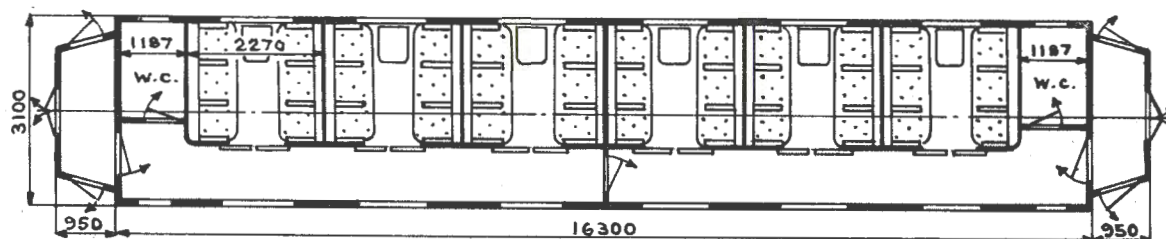
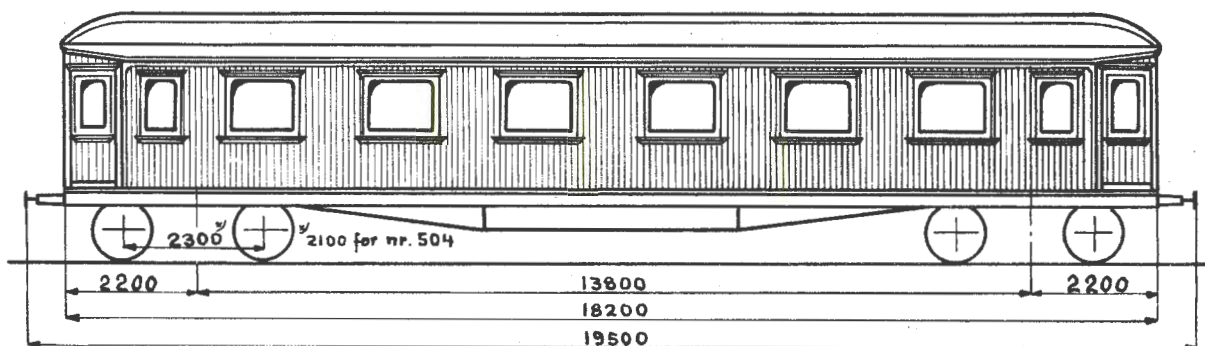

Hovedt. 1844
2026

Vogn nr.	Distriktsmerke	Fabrikant	Byggeår	Omtr. vognvekt i tonn	Sittepl. 1.klasse	Grunnriss	El.varme i kW	Vognutstyr (se side 6)	Merknad
504	D	Str	09	30,5	36			1H.3.5.11.28.39a	Oppr. hovedt. 699. Ny vognkasse Hovedt. 2026 Hovedt. 1844
247	O	"	13	34,5	"			1KK.3.5.11.28.35.39a	
209	"	"	15	"	"			1KK.3.5.11.28.35.39a	
18035	T	Skb	19	33,5	"			1H.3.5.11.28.39a	
18064	D	"	21	34,0	"			1H.3.5.11.28.39a	

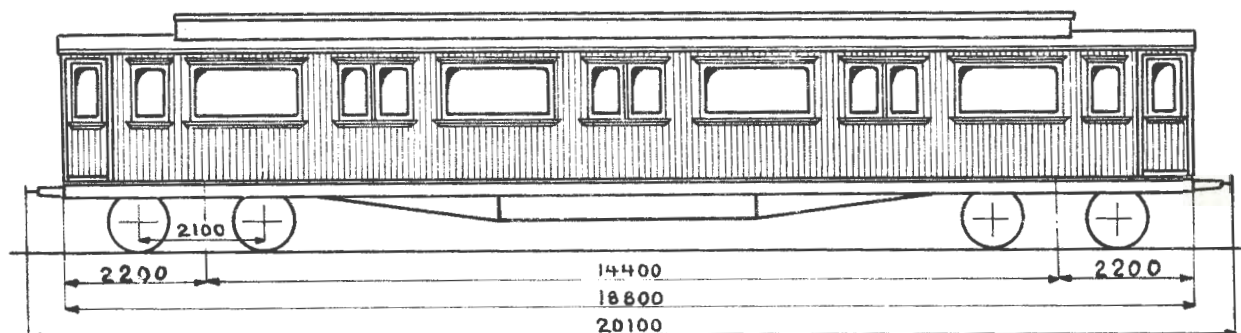

Grunnriss 1

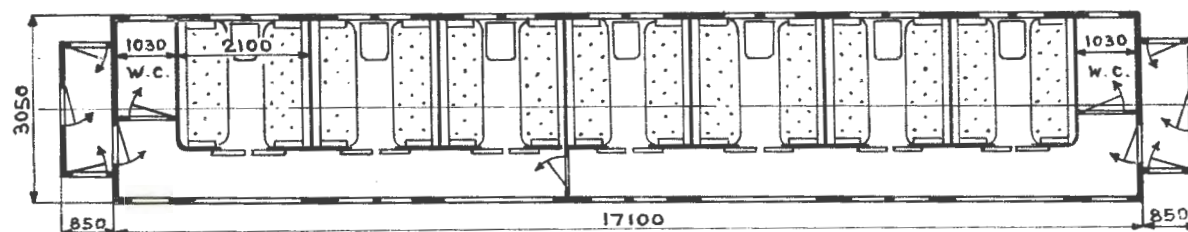

Hovedt.
700
+958

Grunnriss 2

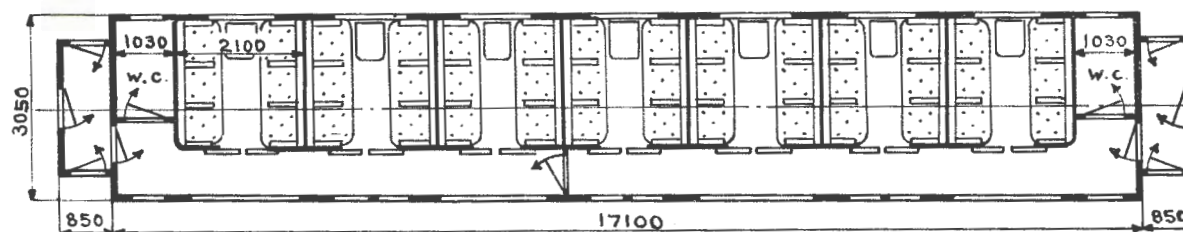

Hovedt.
700
+958

Vogn nr.	Distriktsmerke	Fabrikant	Byggeår	Omt. vognvekt i tonn	Sittepl. 1.klasse	Grunnriss	El. varme i kW	Vognutstyr (se side 6)	Merknad
501	D	Skb	09	34,5	42	2		1H.3.5.12.28.39a	
502	"	"	"	31,5	"	1		1H.3.5.11.28.39a	

Ao2b

TYPE 1

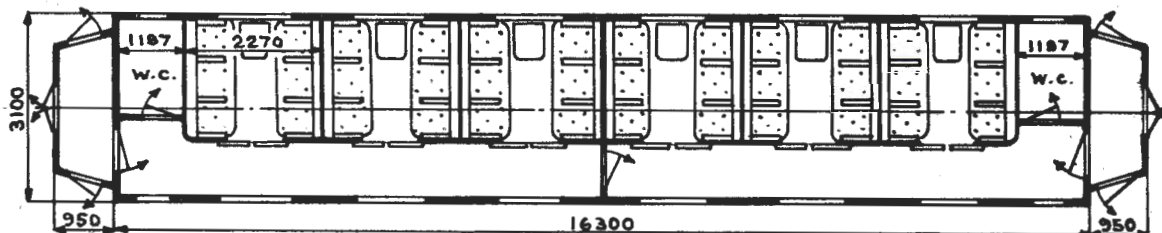
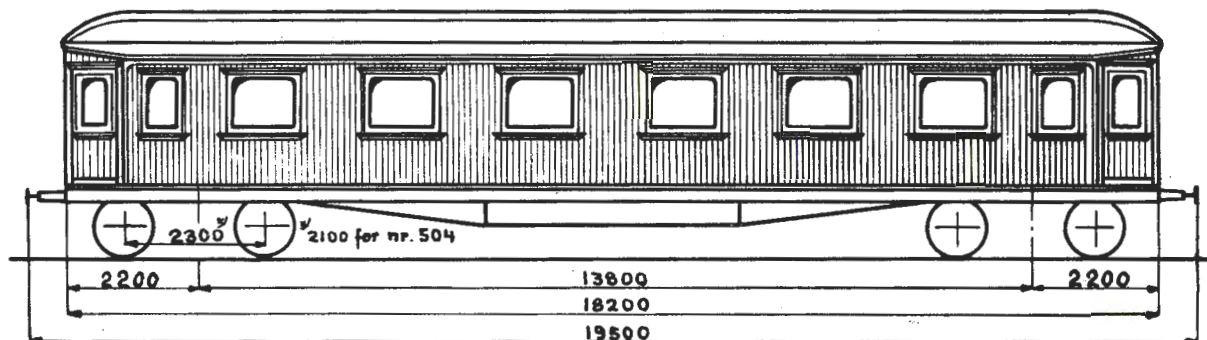

Hovedt. 1844
2026

Vogn nr.	Distriktsmerke	Fabrikant	Byggeår	Omr. vognvekt i tonn	Sittepl. 1.klasse	Grunnpriss	El.varme i kW	Vognutstyr (se side 6)	Merknad
504	D	Str	09	30,5	36			1H.3.5.11.28.39a	Oppr. hovedt. 699. Ny vognkasse Hovedt. 2026 Hovedt. 1844
247	O	"	13	34,5	"			1KK.3.5.11.28.35.39a	
209	"	"	15	"	"			1KK.3.5.11.28.35.39a	
18035	T	Skb	19	33,5	"			1H.3.5.11.28.39a	
18064	D	"	21	34,0	"			1H.3.5.11.28.39a	

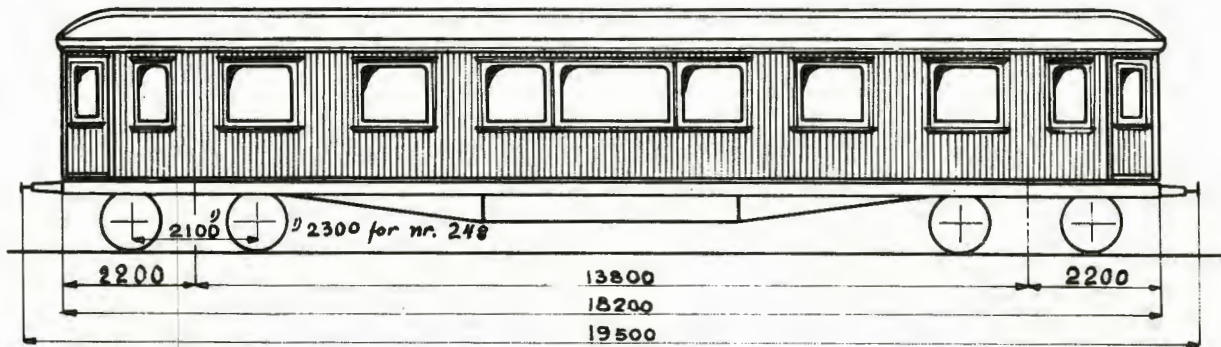

Grunnriss 1

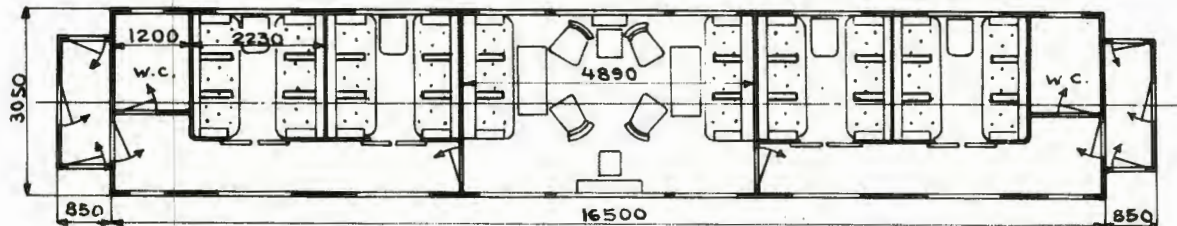

Hovedt. 1134

Grunnriss 2

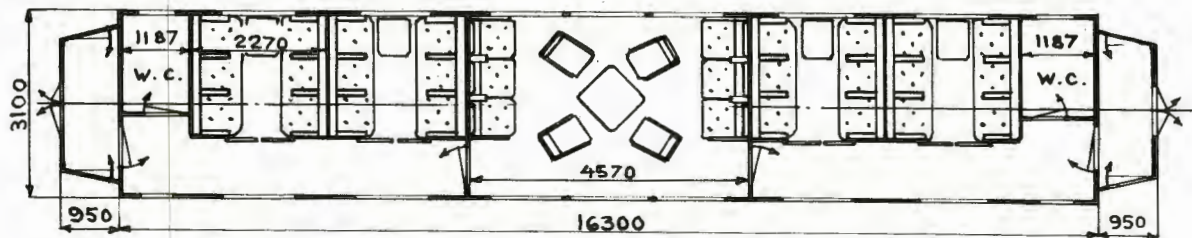

Oppr. hovedt. 2026²⁾

Vogn nr.	Distriktsmerke	Fabrikant	Byggeår	Omr. vognvekt i tonn	Sittepl. 1.klasse	Grunnriss	El. varme i kW	Vognutstyr (se side 6)	Merknad
248	O	Str	13	34,5	34 ³⁾	2		1KK.3.5.11.28.35.39a	
811	T	Skb	10	29,0	"	1		1H.3.5.11.28	
950	B	"	"	"	"	"		1H.3.5.11.28.39a	

2) Forandr. etter tegn. O.d. 3677

3) Herav 10 i salong

Ao2d

TYPE 1

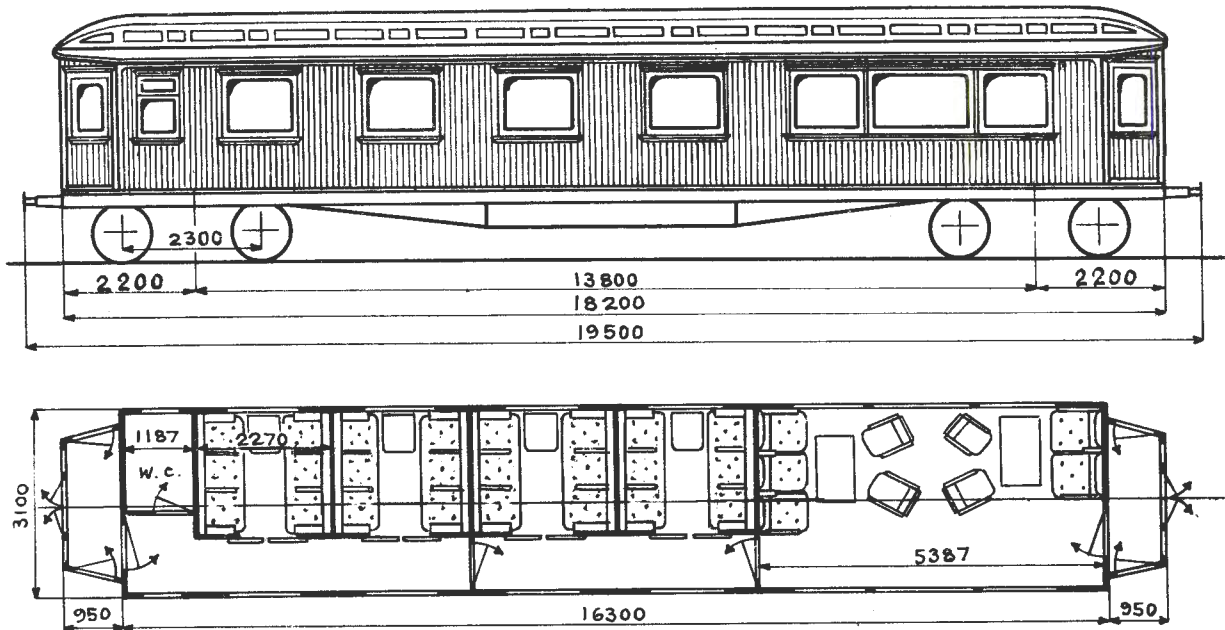

Oppr. hovedt. 1844

Vogn nr.	Distriktsmerke	Fabrikant	Byggeår	Omtr. vognvekt i tonn	Sittepl. 1.klasse	Grunnriss	El.varme i kW	Vognutstyr (se side 6)	Merknad
581	D	Skb	21	33,0	33 ¹⁾			1KK.3.5.11.28.35.39a	

1) Herav 9 i salong

Trykk nr. 751 1.7.57

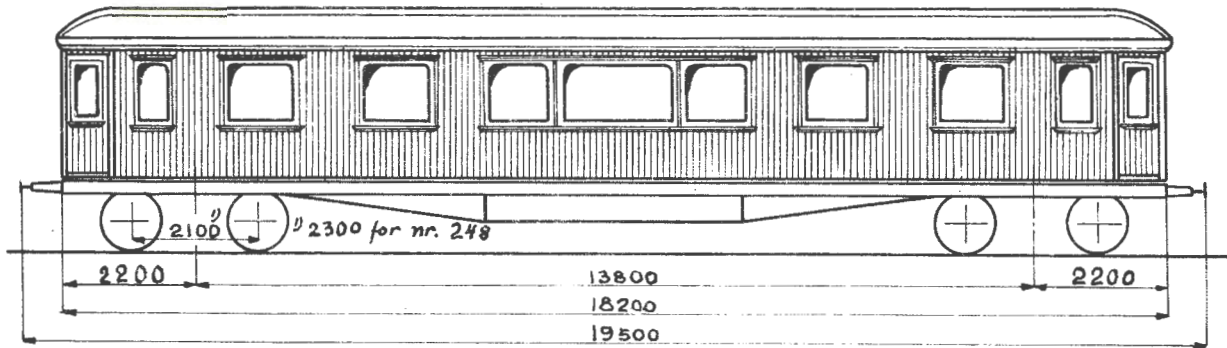

Grunnriss 1

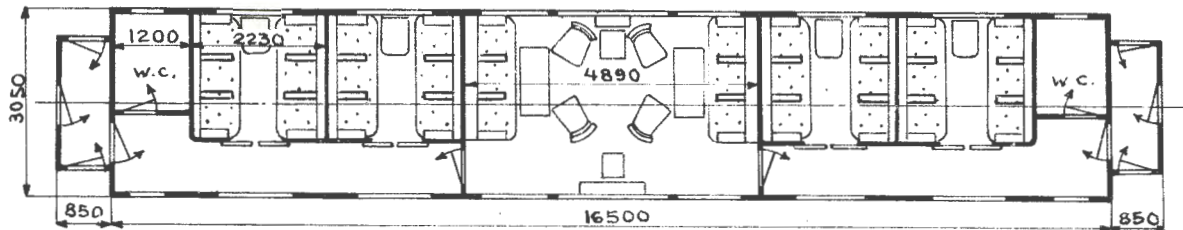

Hovedt. 1134

Grunnriss 2

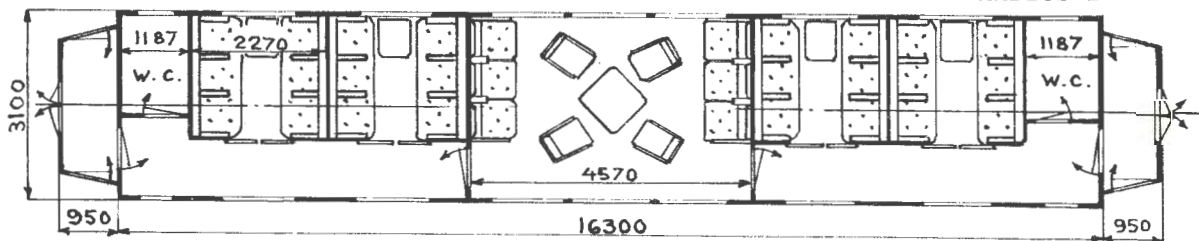

Oppr. hovedt. 2026²⁾

Vogn nr.	Distriktsmerke	Fabrikant	Byggeår	Omr. vognvekt i tonn	Sittepl. 1.klasse	Grunnriss	El. varme i kW	Vognutstyr (se side 6)	Merknad
248	O	Str	13	31,5	34 ³⁾	2		1KK.3.5.11.28.35.39a	
811	T	Skb	10	29,0	"	1		1H.3.5.11.28	
950	B	"	"	"	"	"		1H.3.5.11.28.39a	

2) Forandr. etter tegn. O.d. 3677

3) Herav 10 i salong

Ao2d

TYPE 1

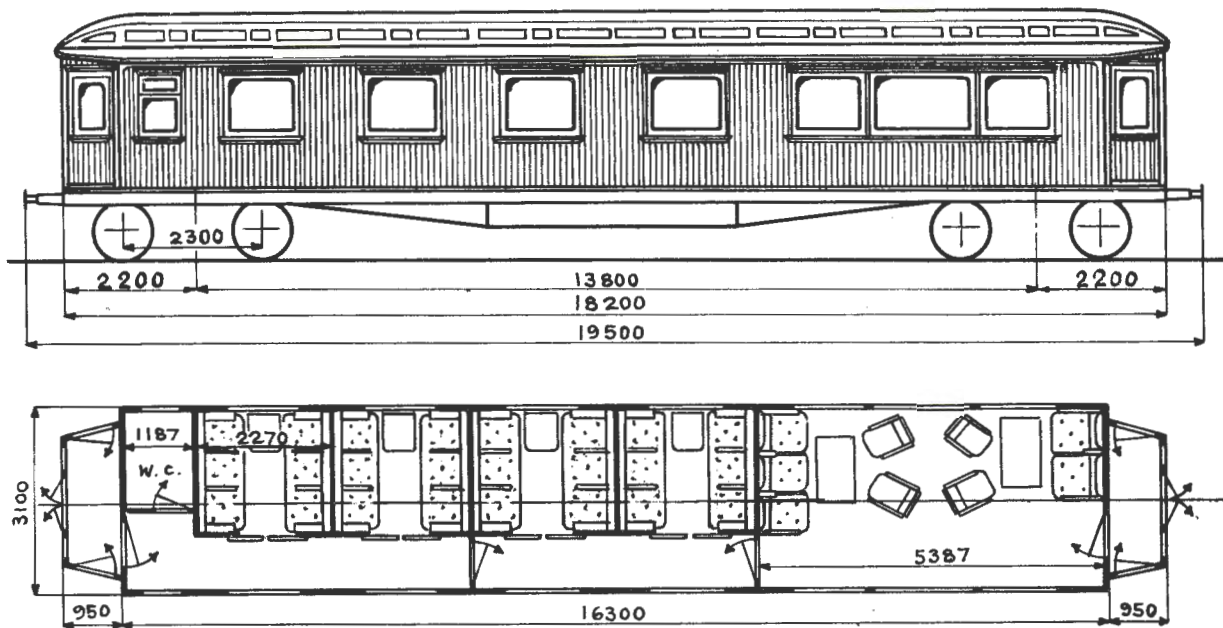

Oppr. hovedt. 1844

Vogn nr.	Distriktsmerke	Fabrikant	Byggeår	Omr. vognvekt i tonn	Sittepl. 1.klasse	Grunnriss	El. varme i kW	Vognutstyr (se side 6)	Merknad
581	D	Skb	21	33,0	33			1KK.3.5.11.28.35.39a	

1) Herav 9 i salong

Trykk nr. 751 1.7.57

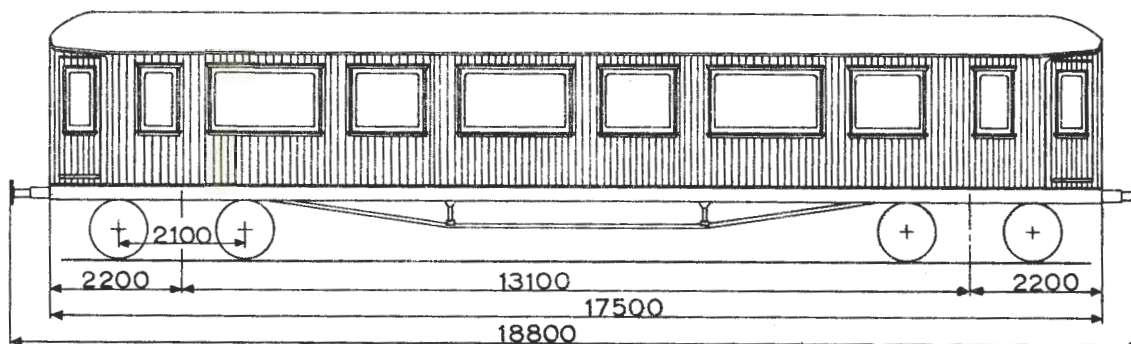

Grunnriss 1

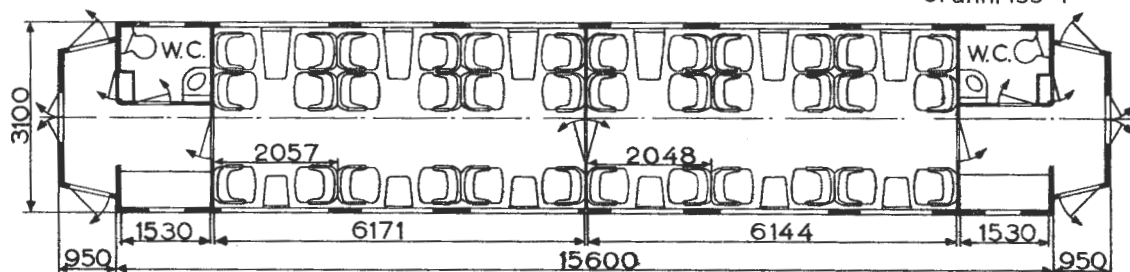

Oppr. hovedt. 2067¹⁾

Grunnriss 2

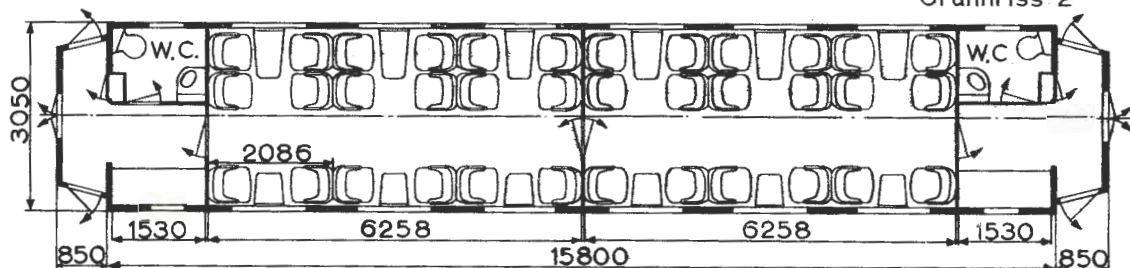

Oppr. hovedt. 993¹⁾

Vogn nr.	Distriktsmerke	Fabrikant	Byggeår	Omtr. vognvekt i tonn	Sittepl. 1. klasse	Grunnriss	El varme i kW	Vognutstyr (se side 6)	Merknad
900	O	Str	09	29,5	36	2		1H. 3. 5. 11. 28. 39a.	
690	"	"	10	29,0	"	"		1H. 3. 5. 11. 28. 39a.	
946	B	"	"	"	"	"		1H. 3. 5. 11. 28. 39a.	
947	"	"	"	28,0	"	"		1H. 3. 5. 11. 28. 39a.	
989	"	Skb	12	28,5	"	1		1H. 3. 5. 11. 28. 39a.	
990	"	"	"	"	"	"		1H. 3. 5. 11. 28. 39a.	

¹⁾ Forandr. etter tegn. 7072

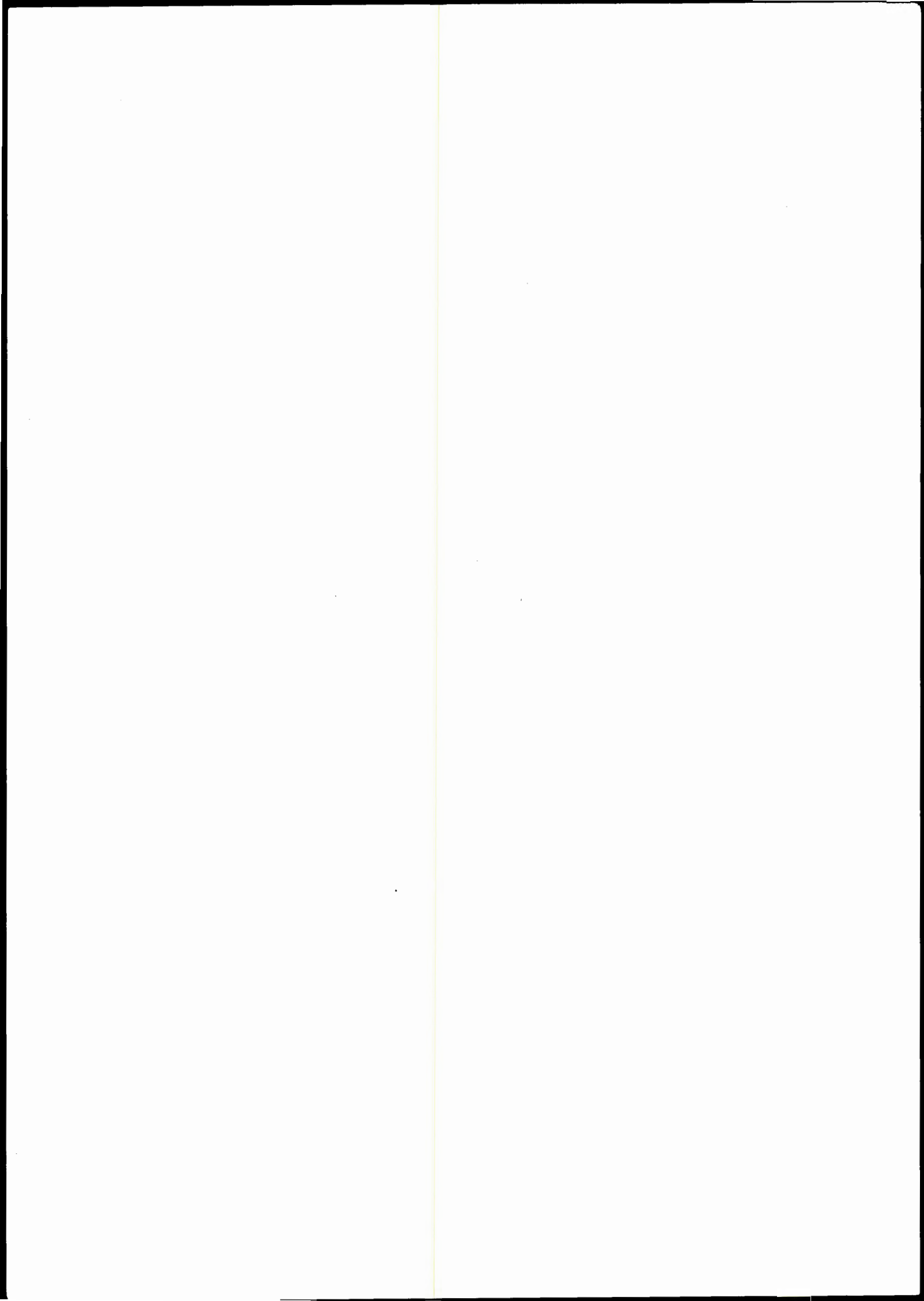

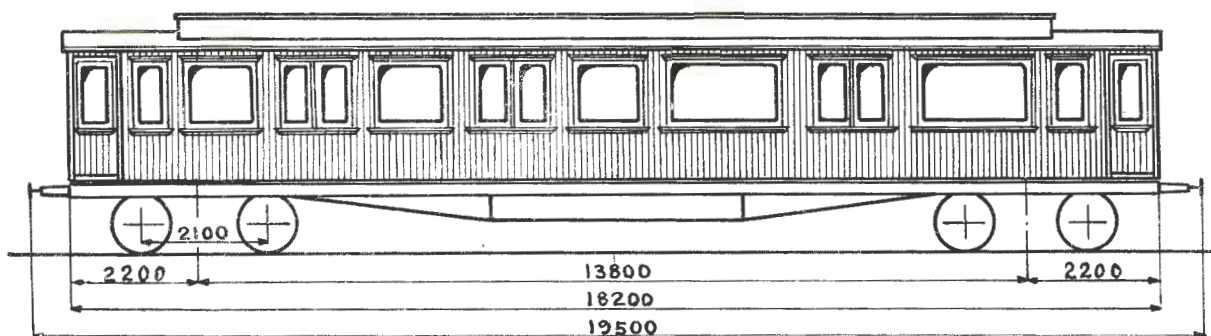

Grunnriss 1

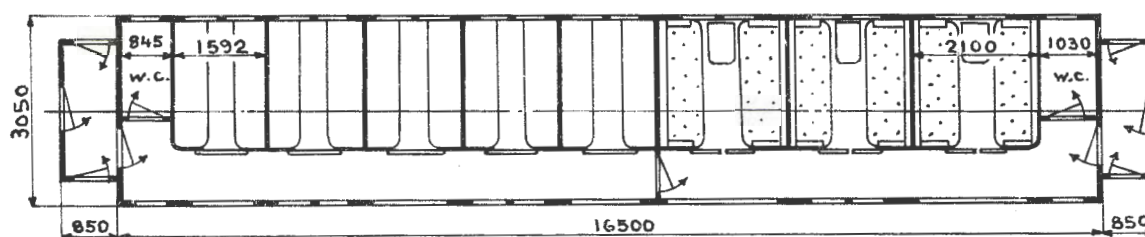

Hovedt.

699
+ 869

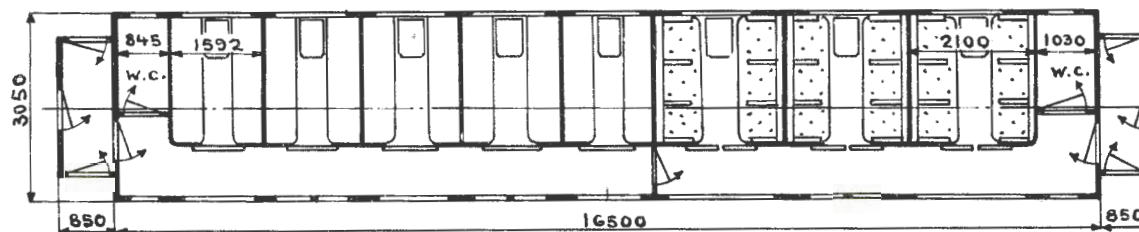

Grunnriss 2

Hovedt.

699
+ 869

Vogn nr.	Distriktsmerke	Fabrikant	Byggeår	Omtr. vognvekt i tonn	Sittepl. pr. vogn		Grunnriss	El. varme i kW	Vognutstyr (se side 6)	Merknad
					1	2				
304	O	Skb	08	30,5	18	40	2		1H.3.5.11.28.39a	Dobbelte plattformendedører
925	B	Str	"	29,0	"	"	1		1H.3.5.11.28.39a	
926	"	"	"	28,0	"	"	2		1H.3.5.11.28.39a	
927	"	"	"	29,0	"	"	1		1H.3.5.11.28.39a	
307	O	Skb	09	28,5	"	"	2		1H.3.5.11.28.39a	

ABo2b

TYPE 1

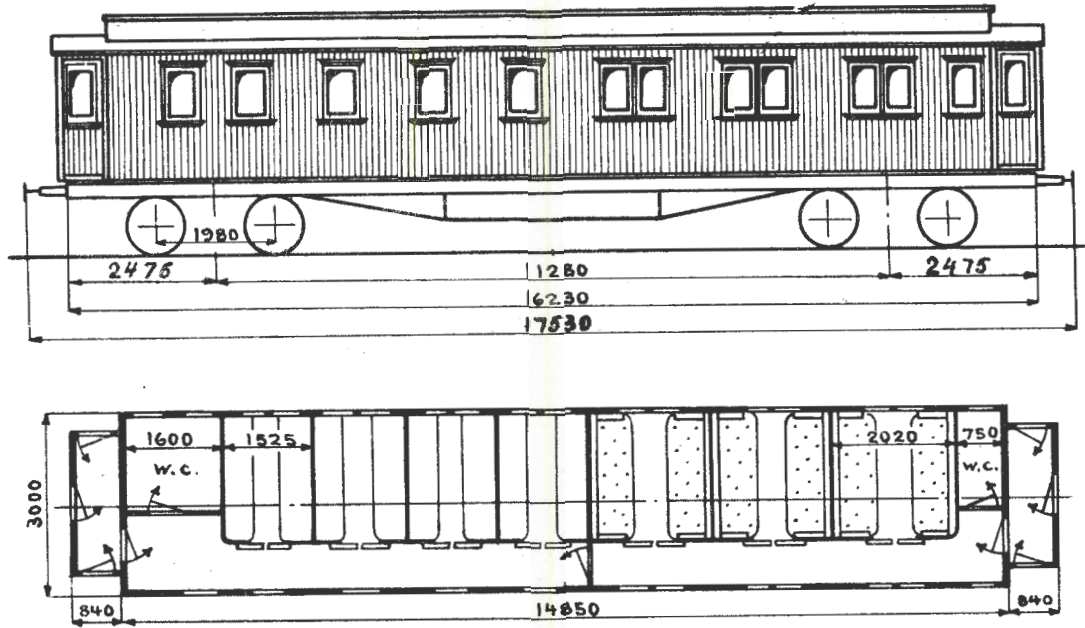

Hovedt. 367

Vogn nr	Distriktsmerke	Fabrikant	Byggeår	Omtr. vognvekt i tonn	Sittepl. pr. vogn		Grunnriss	El. varme i kW	Vognutstyr (se side 6)	Merknad
					1	2				
736	H	Str	96	23,0	18	32			1H.3.5.10	

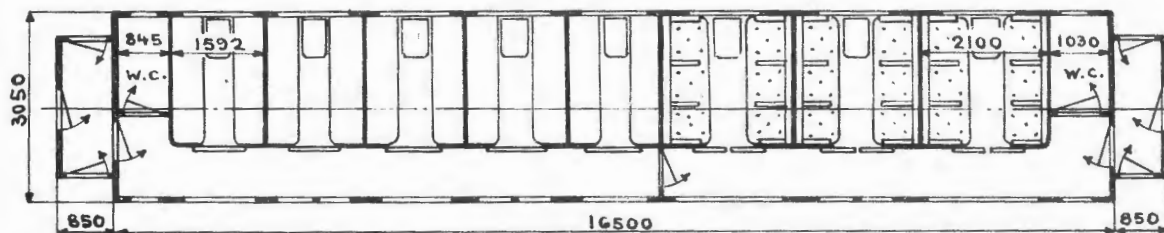
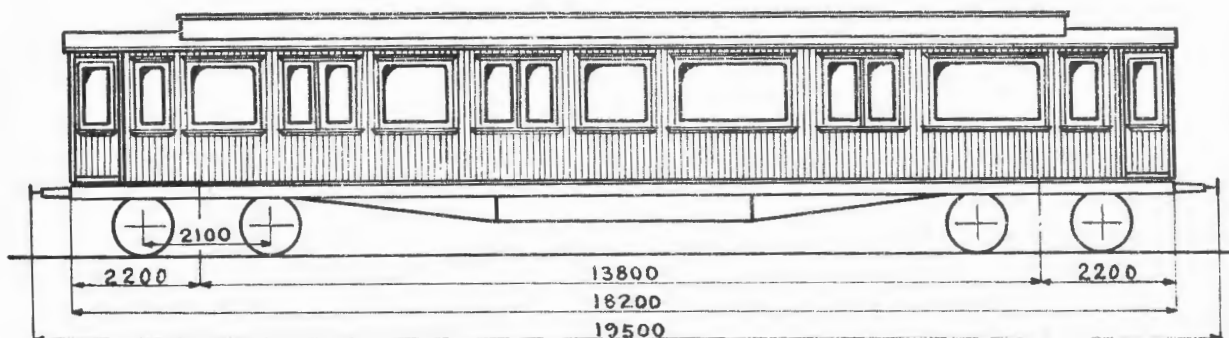

Hovedt. 699+869

Vogn nr.	Distriktsmerke	Fabrikant	Byggeår	Omr. vognvekt i tonn	Sittepl. pr vogn		Grunnriss	El. varme i kW	Vognutstyr (se side 6)	Merknad
					1	2				
304	0	Skb	08	30,5	18	40			1H.3.5.11.28.39a	1)
307	"	"	09	28,5	"	"			1H.3.5.11.28.39a	
926	B	Str	08	28,0	"	"			1H.3.5.11.28.39a	

1) Dobbelte plattformendedører

ABo2b

TYPE 1

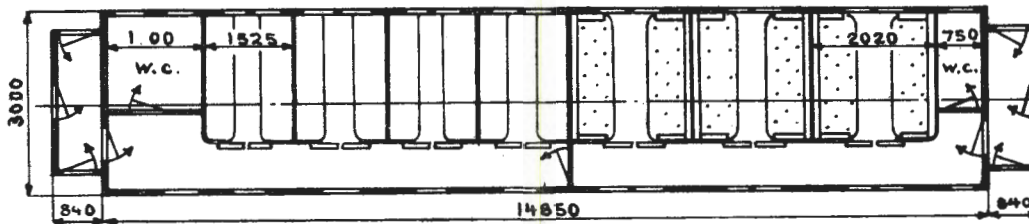
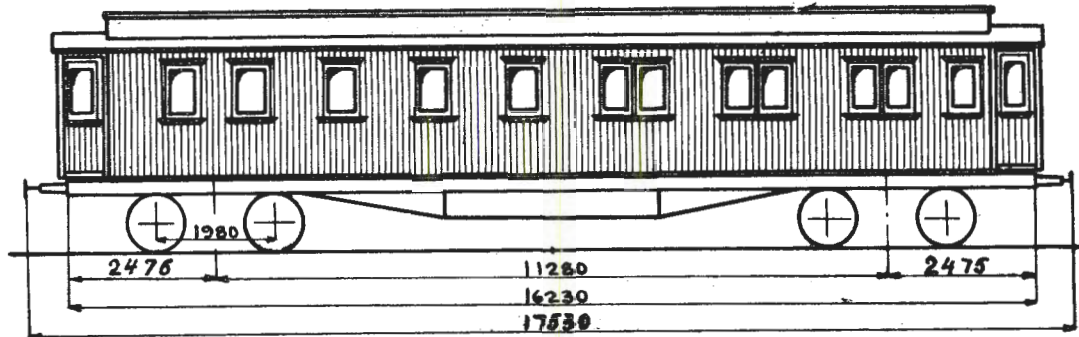

Hovedt. 367

Vogn nr.	Dis.rik smerke	Fabrikant	Byggear	Omr. vognvekt i tonn	Sittepl. pr vogn		Grunn-iss	El.varme i kW	Vognutstyr (se side 6)	Merknad
					1	2				
736	H	Str	96	23,0	18	32			1H.3.5.10	

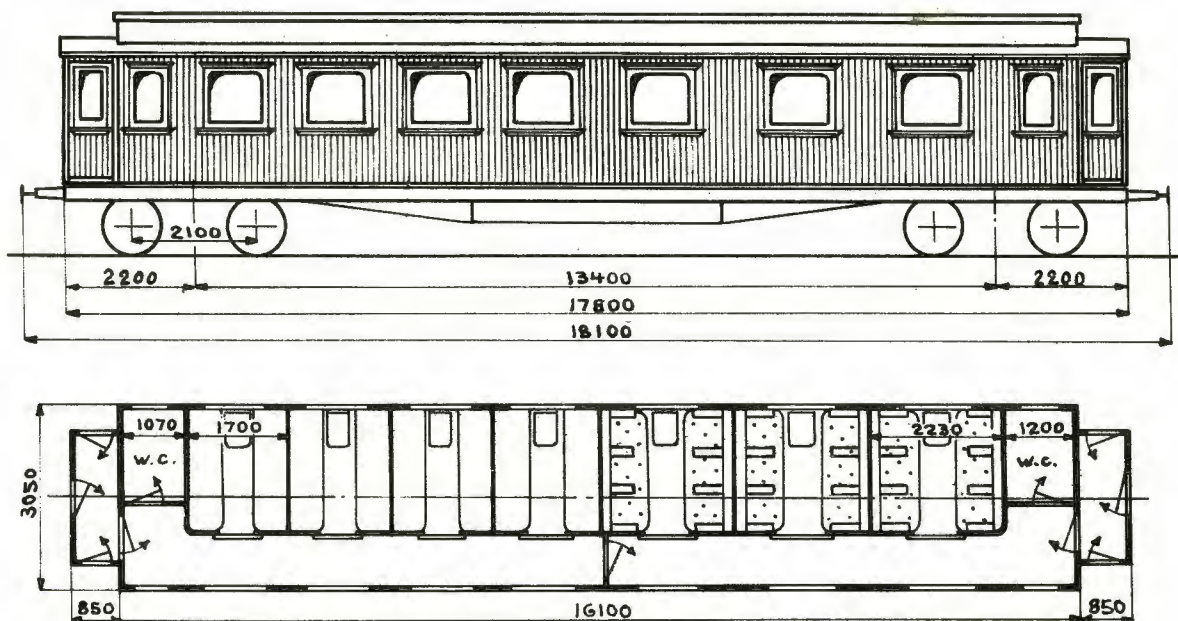

Hovedt. 1058

Vogn nr.	Distriktsmerke	Fabrikant	Byggeår	Omr. vognvekt i tonn	Sittepl. pr. vogn		Grunnriss	El. varme i kW	Vognutstyr (se side 6)	Merknad		
					1	2						
					klasse							
473	O	Str	11	31,0	18	32			1H.3.5.11.28.39a			
542	D	"	"	"	"	"			1H.3.5.11.28.39a			
543	"	"	"	30,0	"	"			1H.3.5.11.28.39a			
544	"	"	"	30,5	"	"			1H.3.5.11.28.39a			

ABo2b

TYPE 3

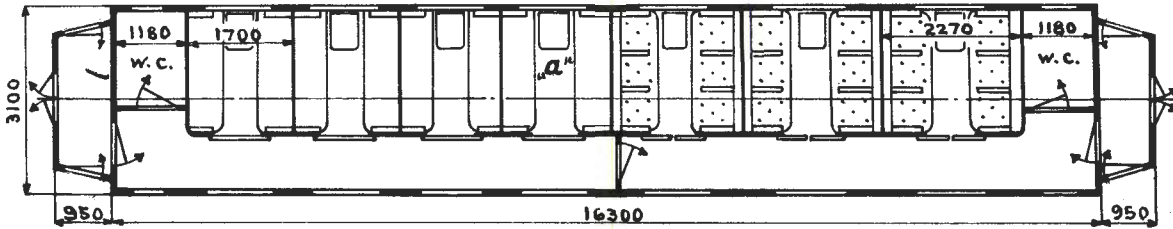
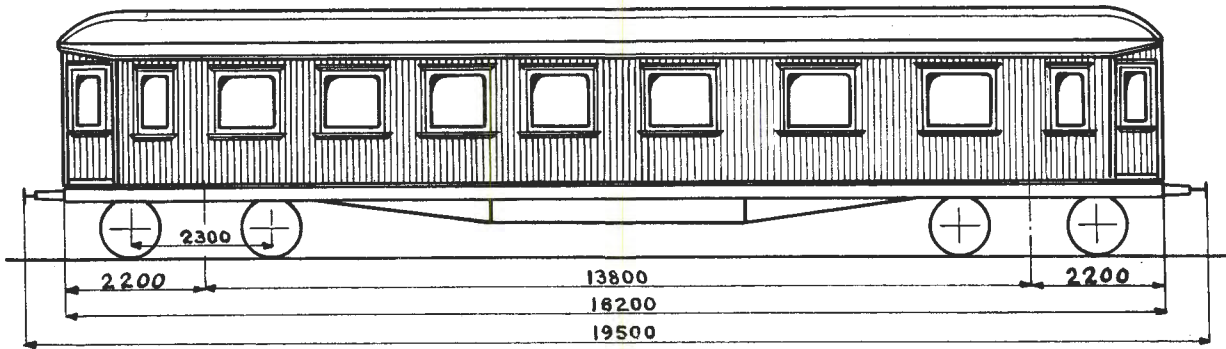

Hovedt. 1840
2089

Vogn nr	Distriktsmerke	Fabrikant	Byggeår	Omr. vognvekt i tonn	Sittepl. pr. vogn		Grunnriss	El. varme i kW	Vognutstyr (se side 6)	Merknad
					1	2				
136	O	Skb	15	34,0	18	32			1H.3.5.11.28.35.39a	
137	"	"	"	33,5	"	"			1KK.3.5.11.28.39a	
138	"	Str	18	34,0	"	"			1KK.3.5.11.28.39a	1)
139	"	"	"	33,5	"	"			1KK.3.5.11.28.39a	
348	"	"	17	32,5	"	"			1KK.3.5.11.28.39a	
349	"	"	18	"	"	"			1KK.3.5.11.28.39a	1)
350	"	"	"	33,0	"	"			1KK.3.5.11.28.39a	1)
351	"	"	"	"	"	"			1KK.3.5.11.28.39a	
352	"	"	"	33,5	"	"			1KK.3.5.11.28.39a	
573	D	Skb	15	"	"	"			1H.3.5.11.28.39a	
574	"	"	"	34,0	"	"			1H.3.5.11.28.39a	
740	H	Str	17	33,5	"	"			1H.3.5.11.28.39a	Sykekupé "a"
883	O	"	16	"	"	"			1KK.3.5.11.28.39a	
18002	T	"	13	33,0	"	"			1H.3.5.11.28	2) Sykekupé "a"
18018	"	Skb	15	"	"	"			1H.3.5.11.28	1)
18024	D	"	16	"	"	"			1H.3.5.11.28.39a	
18025	"	"	"	32,5	"	"			1H.3.5.11.28.39a	
18065	"	"	21	33,0	"	"			1H.3.5.11.28.39a	
18066	"	"	"	34,0	"	"			1H.3.5.11.28.39a	

1) Plattf.sidedører slår ut
2) Hovedt. 2089

Trykk nr. 751 1.7.57

Vogn nr.	Distriktsmerke	Fabrikant	Byggeår	Omr. vognvekt i tonn	Sittepl. pr vogn		Grunnriss	El. varme i kW	Vognutstyr (se side 6)	Merknad
					1	2				
					klasse					
138	O	Str	18	34,0	18	32	2	1KK.3.5.11.28.39a	PJ ttformsid dører låst	
139	"	"	"	33,5	"	"	"	1KK.3.5.11.28.39a		
349	"	"	"	32,5	"	"	"	1KK.3.5.11.28.39a		
350	"	"	"	33,0	"	"	1	1KK.3.5.11.28.39a		
351	"	"	"	"	"	"	2	1KK.3.5.11.28.39a		
352	"	"	"	33,5	"	"	"	1KK.3.5.11.28.39a		
18065	D	Skb	21	33,0	"	"	"	1H.3.5.11.28.39a		
18066	"	"	"	34,0	"	"	"	1H.3.5.11.28.39a		

ABo2c

TYPE 1

Stålvogner

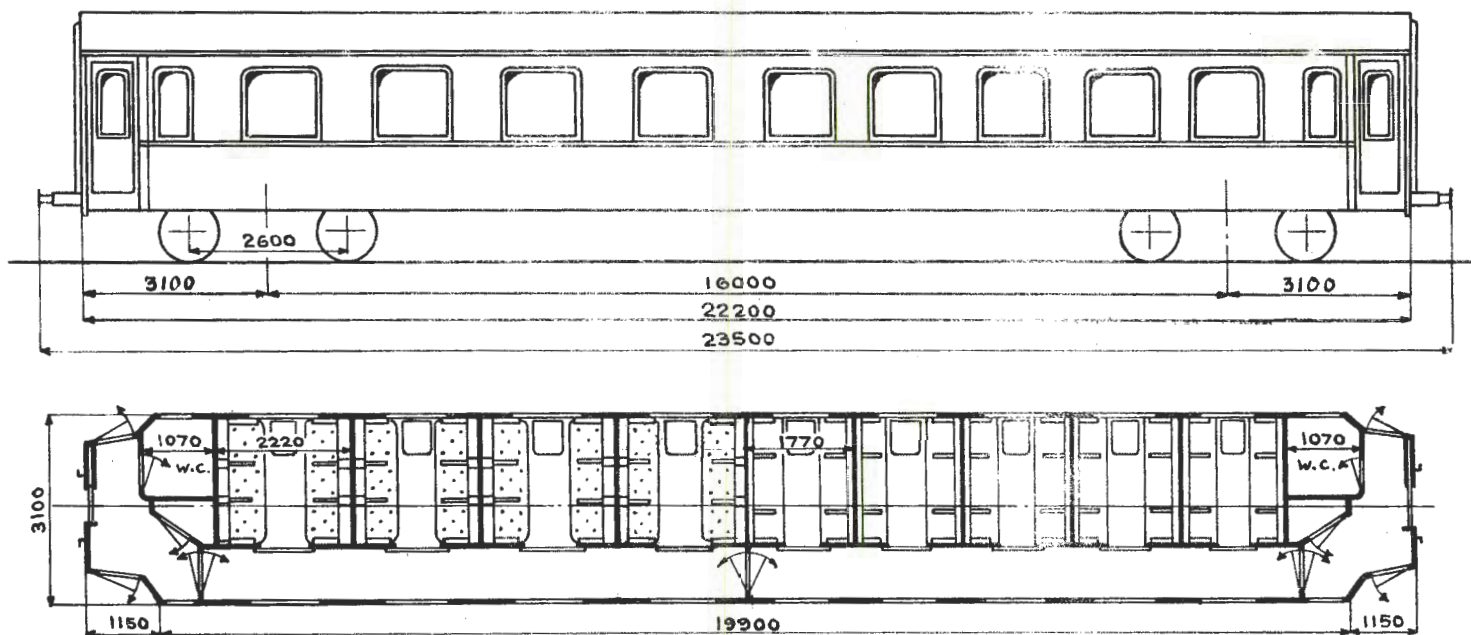

Hovedt. 3600

Vogn nr	Distriktsmerke	Fabrikant	Byggeår	Omtr. vognvekt i tonn	Sittepl. pr. vogn		Grunnriss	El. varme i kW	Vognutstyr (se side 6)	Merknad		
					1	2						
					klasse							
19061	0	Str	35	37,0	24	40		28	1KK.3.5.11.28.39a			
19062	"	"	"	36,0	"	"		"	1KK.3.5.11.28.39a			
19063	"	Skb	"	37,0	"	"		"	1KK.3.5.11.28.39a			

ABo2c

TYPE 1
Stålvogner

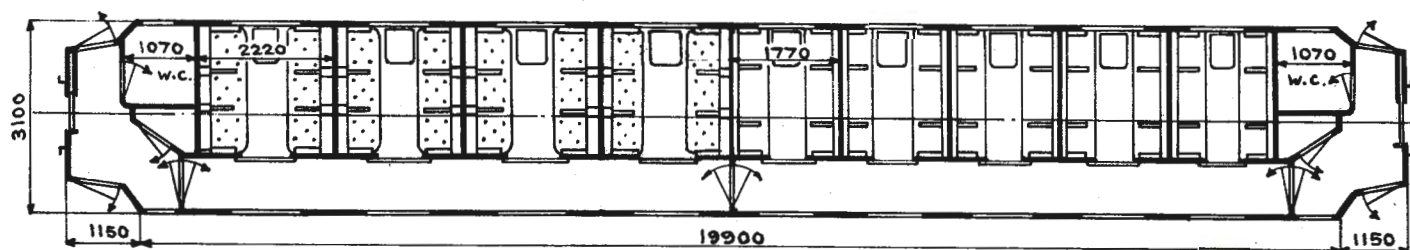
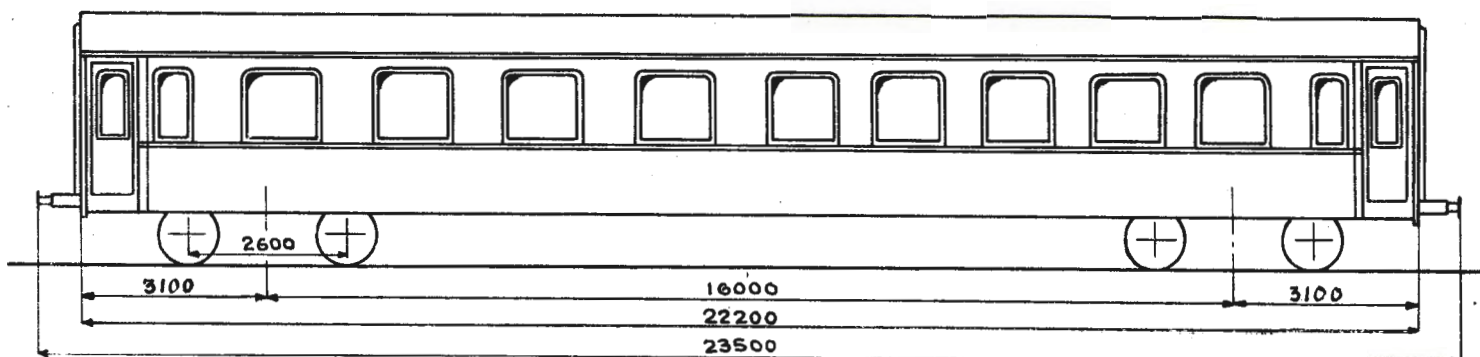

Hovedt. 3600

Vogn nr	Distriktsmerke	Fabrikant	Byggeår	Omr. vognvekt i tonn	Sittepl. pr. vogn		Grunnriss	El.varme i kW	Vognutstyr (se side 6)	Merknad
					1	2				
19061	0	Str	35	37,0	24	40		28	LKK.3.5.11.28.39a	
19062	"	"	"	36,0	"	"		"	LKK.3.5.11.28.39a	
19063	"	Skb	"	37,0	"	"		"	LKK.3.5.11.28.39a	

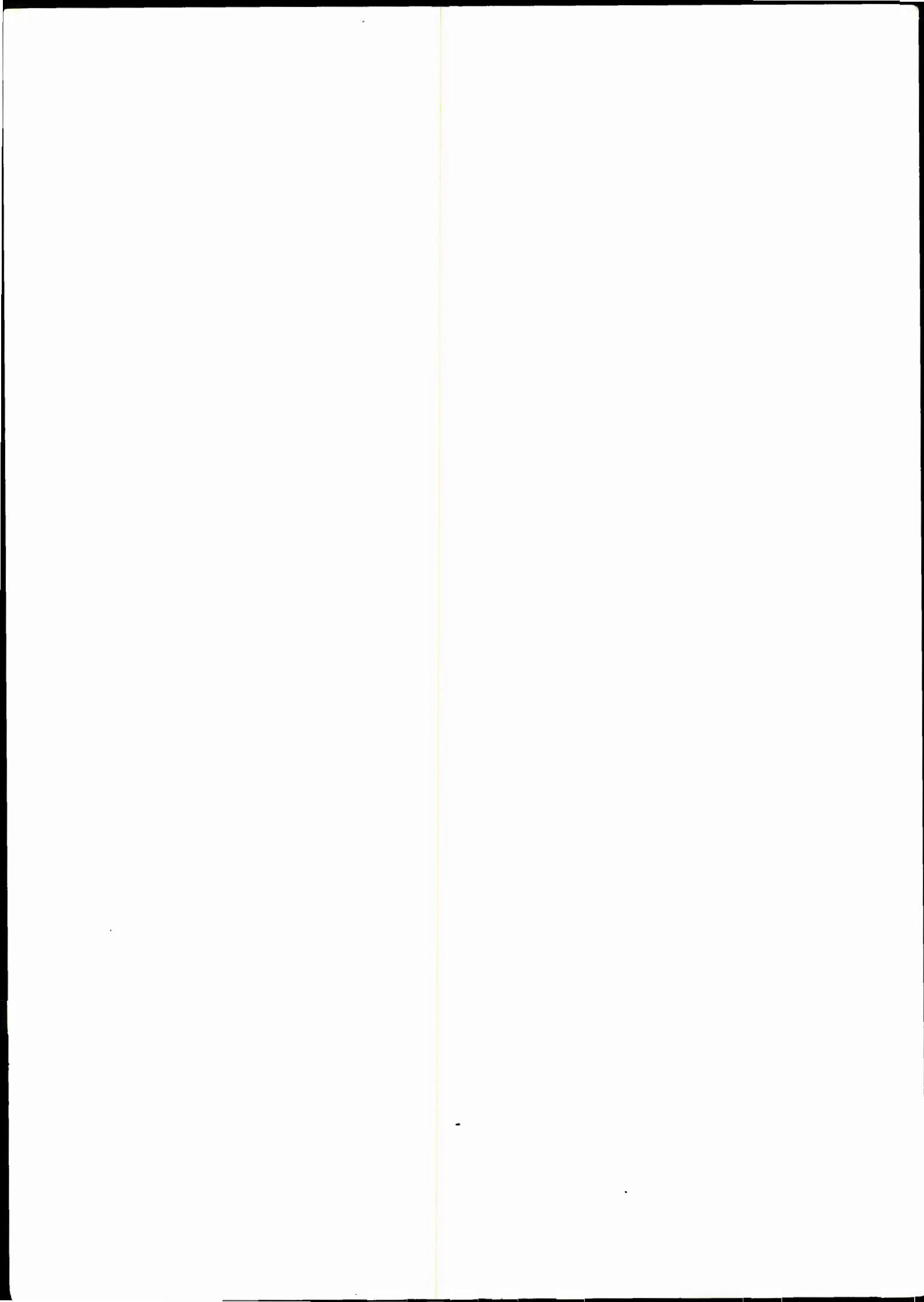

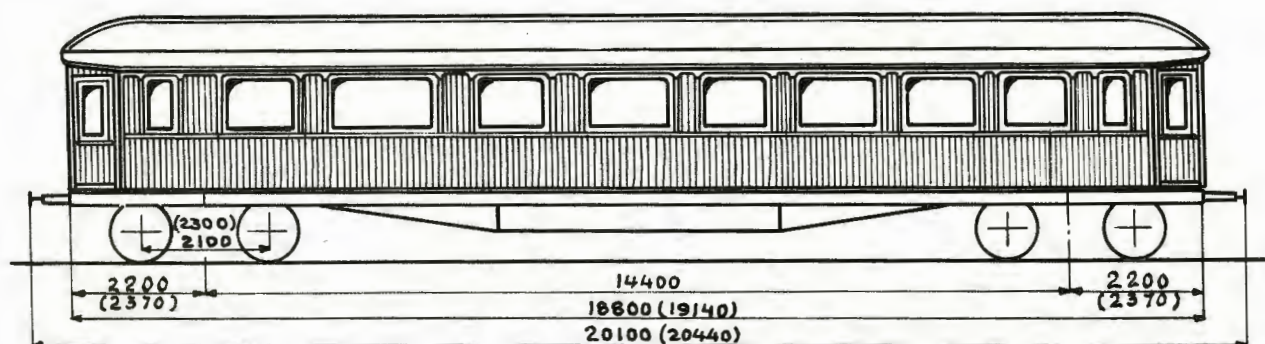

Måli () gjelder vogner etter grunnriss 2.

Grunnriss 1

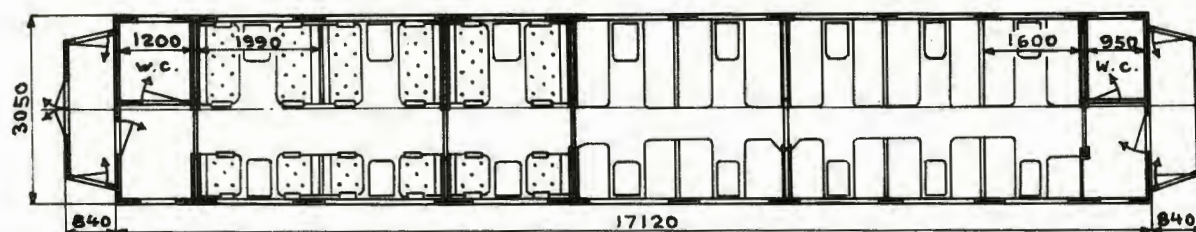

Hovedt.
B.205

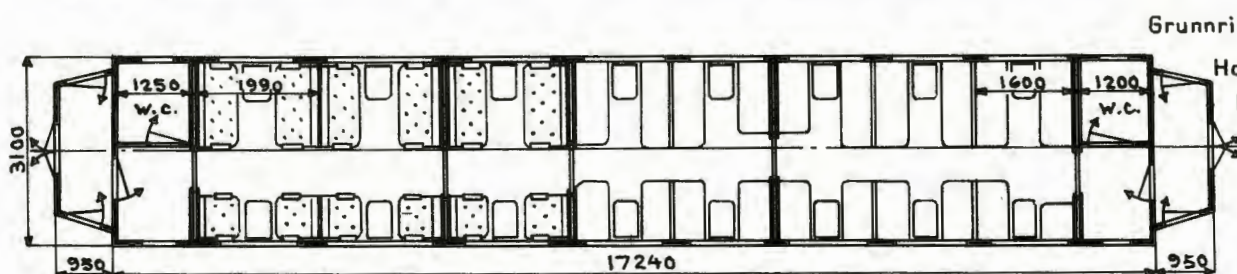

Grunnriss 2

Hovedt.
B.268

Vogn nr.	Distriktsmerke	Fabrikant	Byggeår	Omr. vognvekt i tonn	Sittepl. pr. vogn		Grunnriss	El. varme i kW	Vognutstyr (se side 6)	Merknad
					1	2				
34	0	Skb	09	30,0	18	49	1		1H.3.5.11.28.39a	
35	"	"	10	32,0	"	"	"		1H.3.5.11.28.39a	
36	"	Str	12	34,5	"	47	2		1H.3.5.11.28.39a	Faste seter m/ armlener i 1. kl. avd.
37	"	"	13	33,0	"	"	"		1H.3.5.11.28.39a	

ABFo2a

TYPE 1

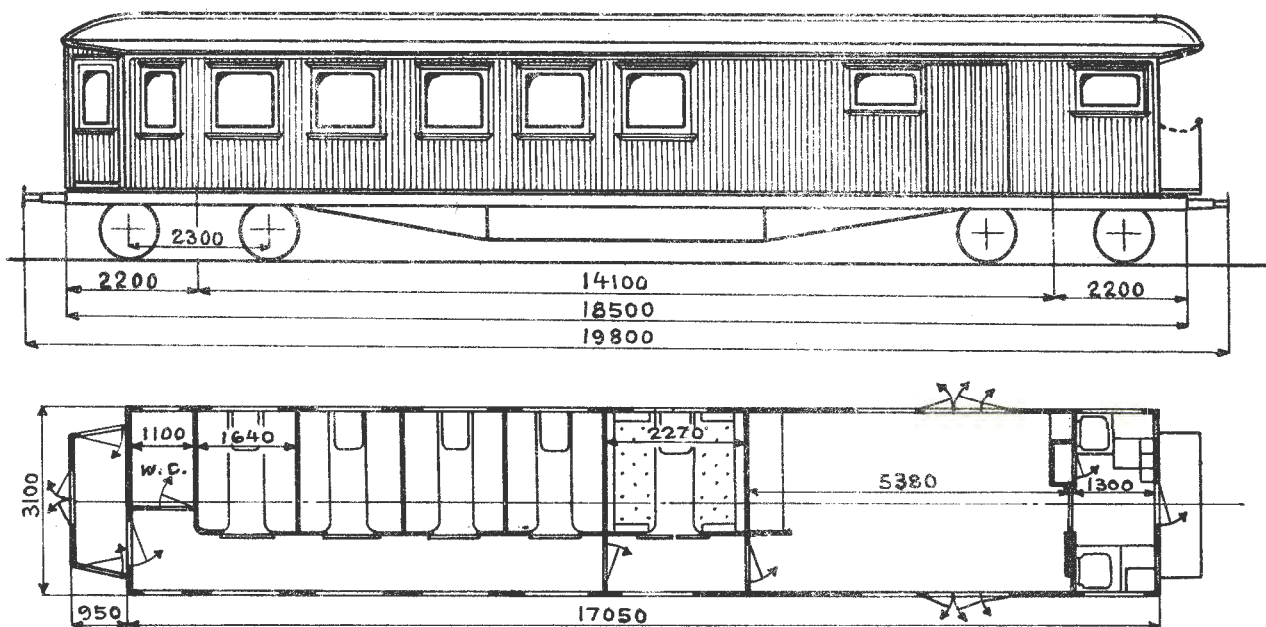

Oppr. hovedt. 1841¹⁾

Vogn nr.	Distriktsmerke	Fabrikant	Byggeår	Omr. vognvekt i tonn	Sittepl. pr vogn		Grunnriss	El. varme i kW	Vognutstyr (se side 6)	Merknad
					1	2				
799	H	Str	24	30,5	6	32			1H.3.5.8.11.28	

1) 1 kupé fjernet og 1 kupé omb. til 2. kl. kupé

ABZo2a

TYPE 1

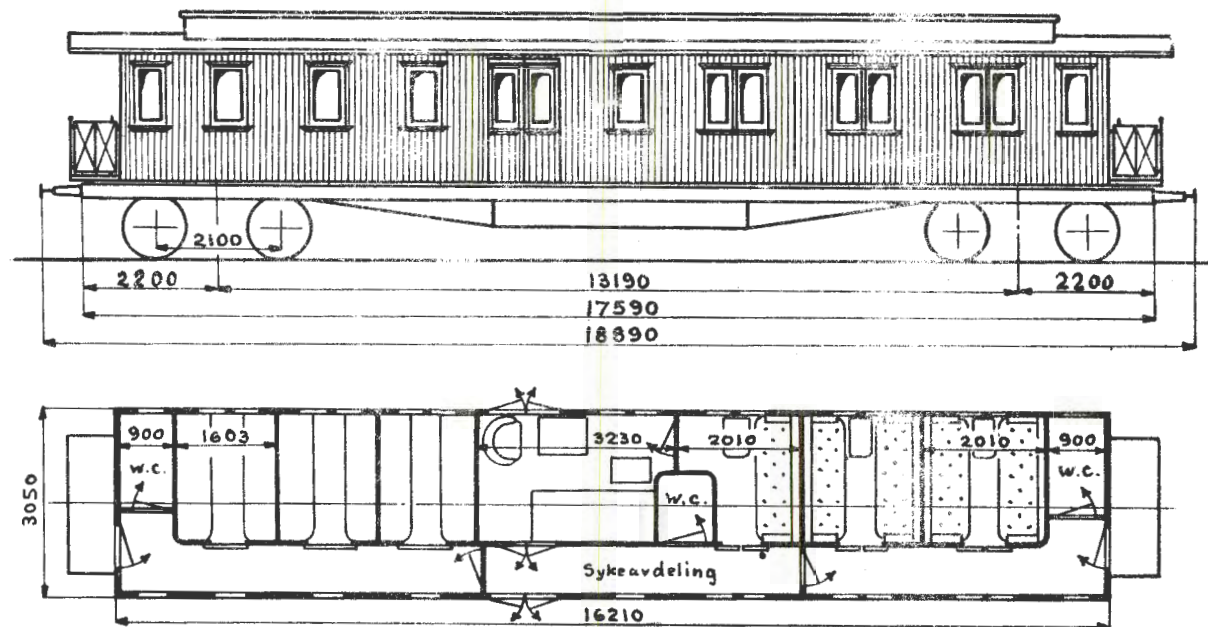

Oppr. hovedt. 469

Vogn nr.	Distriktsmerke	Fabrikant	Byggeår	Omtr. vognvekt i tonn	Sittepl. pr. vogn		Grunnriss	El. varme i kW	Vognutstyr (se side 6)	Merknad
					1	2				
					klasse					
133	H	Skb	00	27,5	12	24			1H.3.5.7.11	

ABZo2a

TYPE 2

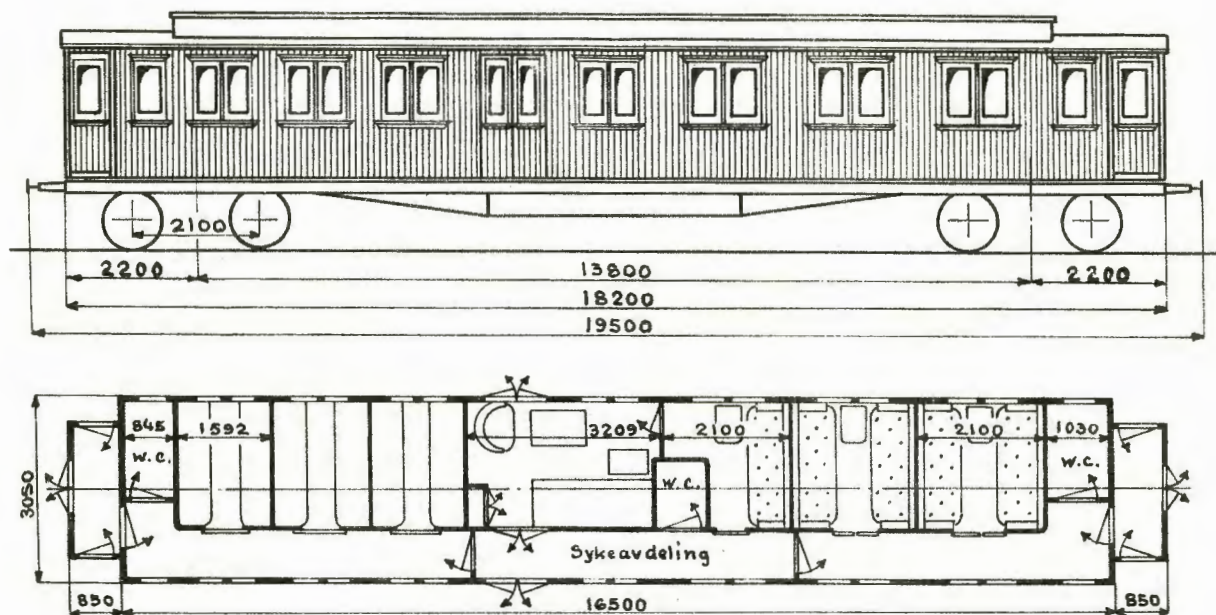

Oppr. hovedt. 699

Vogn nr	Distriktsmerke	Fabrikant	Byggeår	Omr. vognvekt i tonn	Sittepl. pr. vogn		Grunnriss	El.varme i kW	Vognutstyr (se side 6)	Merknad
					1	2				
135	O	Str	04	29,5	12	24			1KK.3.5.11.28.39a	Faste seter m/ armlener i 1. kl. avd.
924	B	"	05	"	"	"			1H.3.5.7.11.39a	

ABZo2b

TYPE 1

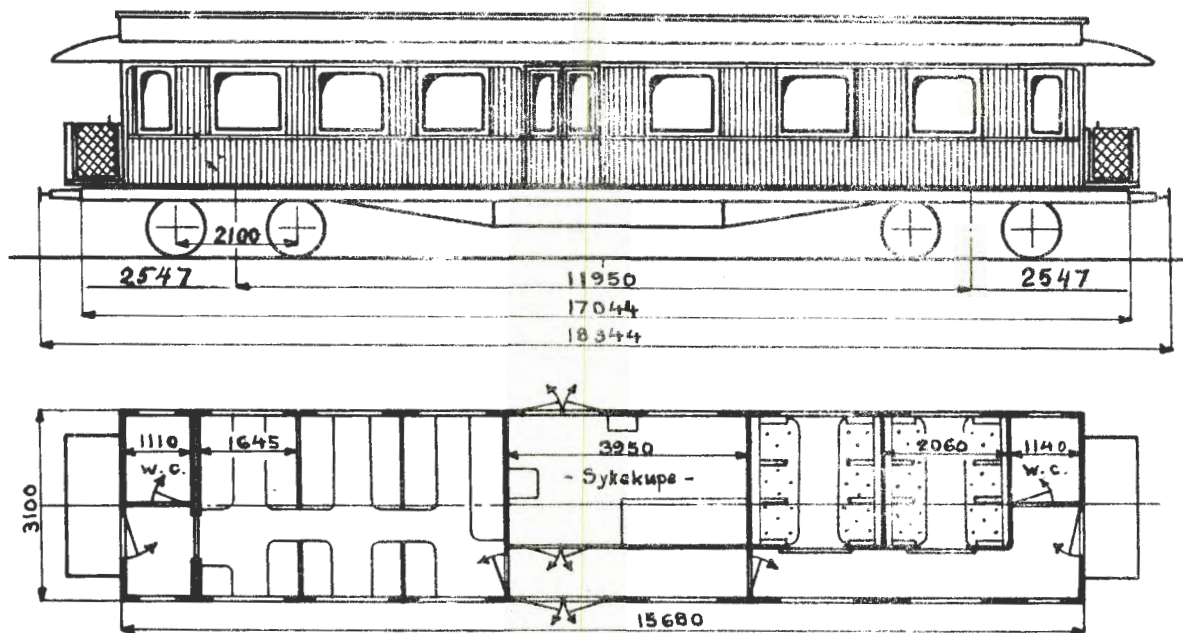

Hovedt. B. 438

Vogn nr.	Distriktsmerke	Fabrikant	Byggeår	Omr. vognvekt i tonn	Sittepl. pr. vogn		Grunnriss	El.varme i kW	Vognutstyr (se side 6)	Merknad
					1	2				
31	0	Skb	95	30,5	12	28			1H.3.5.8.11.39a	Ny vognkasse i 1919

ABZo2a

TYPE 2

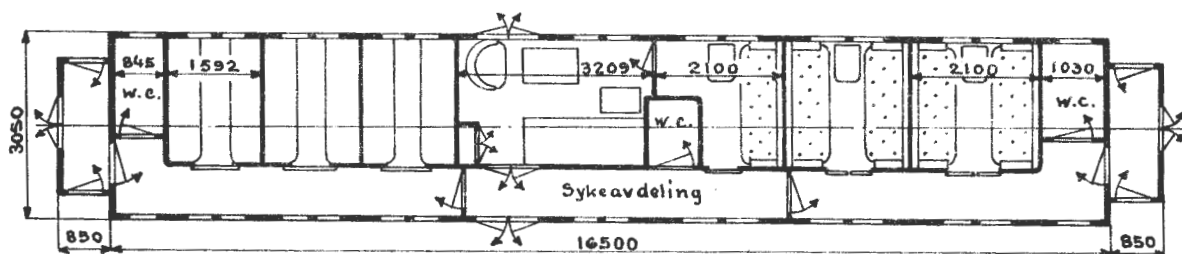
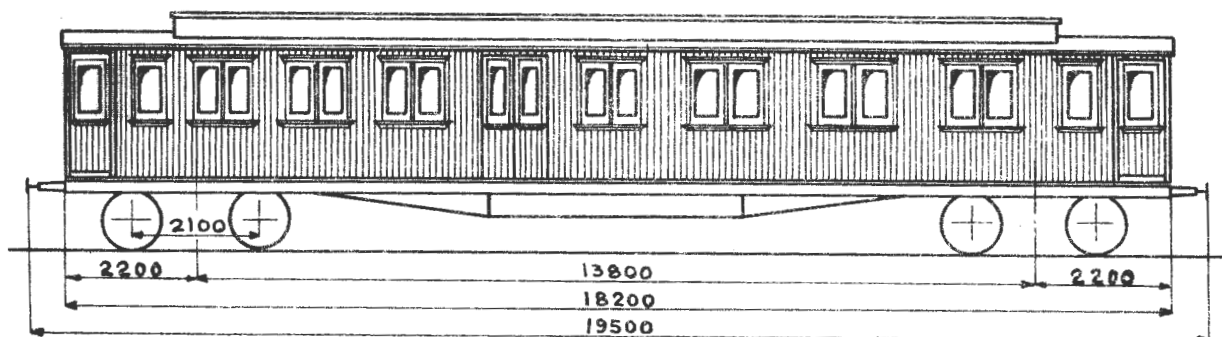

Oppr. hovedt. 699

Vogn nr	Distriktsmerke	Fabrikant	Byggeår	Omtr. vognvekt i tonn	Sittepl. pr. vogn		Grunnriis	El. varme i kW	Vognutstyr (se side 6)	Merknad
					1	2				
135	0	Str	04	29,5	12	24			1KK.3.5.11.28.39a	1)
924	B	"	05	"	"	"			1H.3.5.7.11.28.39a	2)

- 1) Elektrisk utstyr for jernlunge
- 2) Faste seter m/ armlener i 1. kl. avd.

ABZo2b

TYPE 1

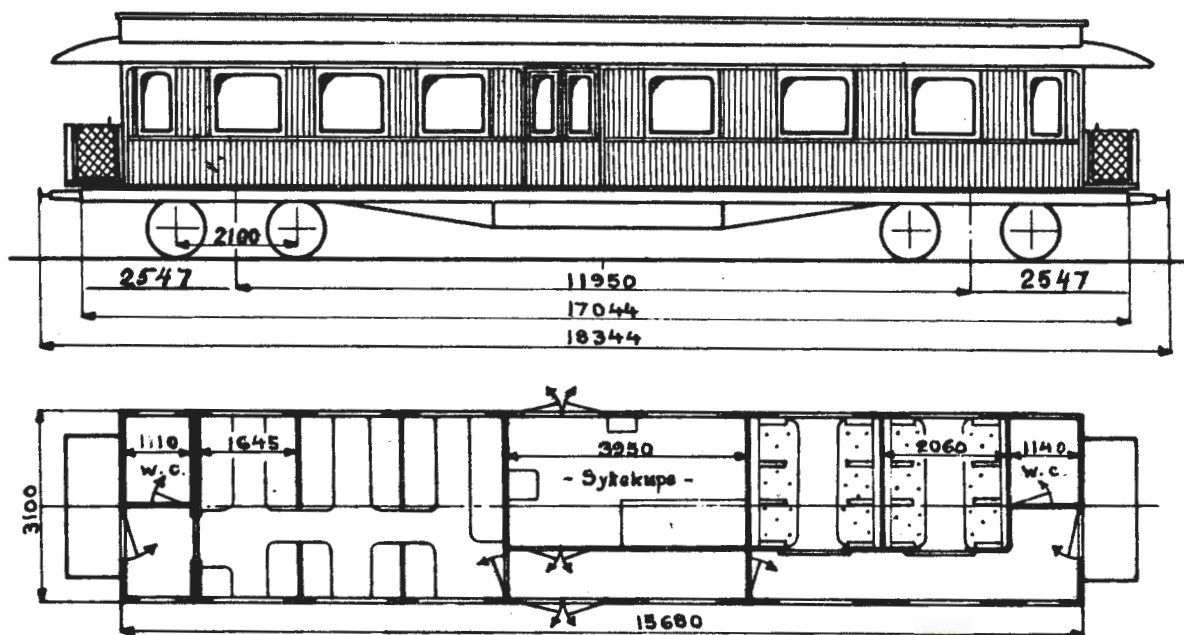

Hovedt. B. 438

Vogn nr	Distriktsmerke	Fabrikant	Byggeår	Omtr. vognvekt i tonn	Sittepl. pr vogn		Grunnriss	El. varme i kW	Vognutstyr (se side 6)	Merknad
					1	2				
31	0	Skb	95	30,5	12	28			1H.3.5.8.11.39a	Ny vognkasse i 1919

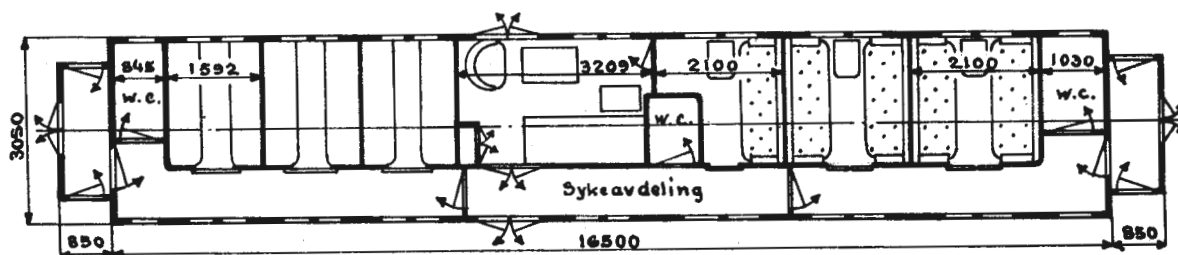
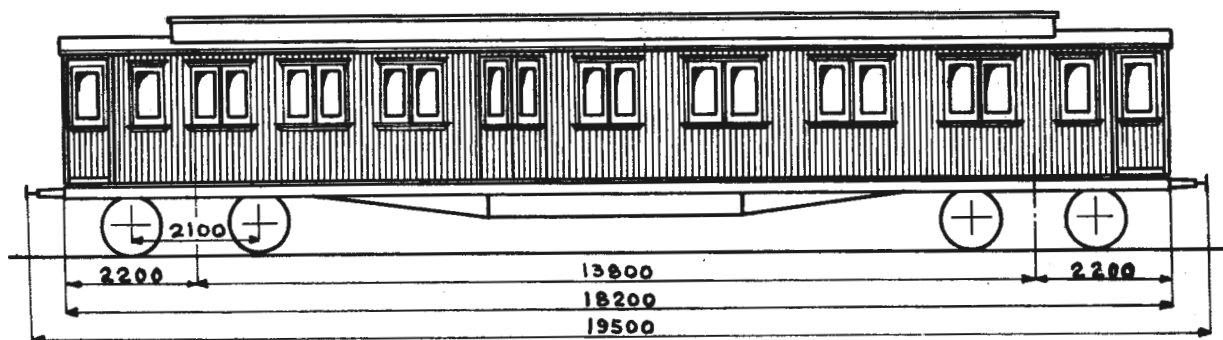

Oppr. hovedt. 699

Vogn nr	Distriktsmerke	Fabrikant	Byggeår	Omr. vognvekt i tonn	Sittepl. pr. vogn		Gr unnriss	El. varme i kW	Vognutstyr (se side 6)	Merknad		
					1	2						
					klasse							
135	0	Str	04	29,5	12	24			1KK.3.5.11.28.39a	Faste seter m/ armlener i 1. kl. avd.		
924	B	"	05	"	"	"			1H.3.5.7.11.28.39a			

ABZo2b

TYPE 1

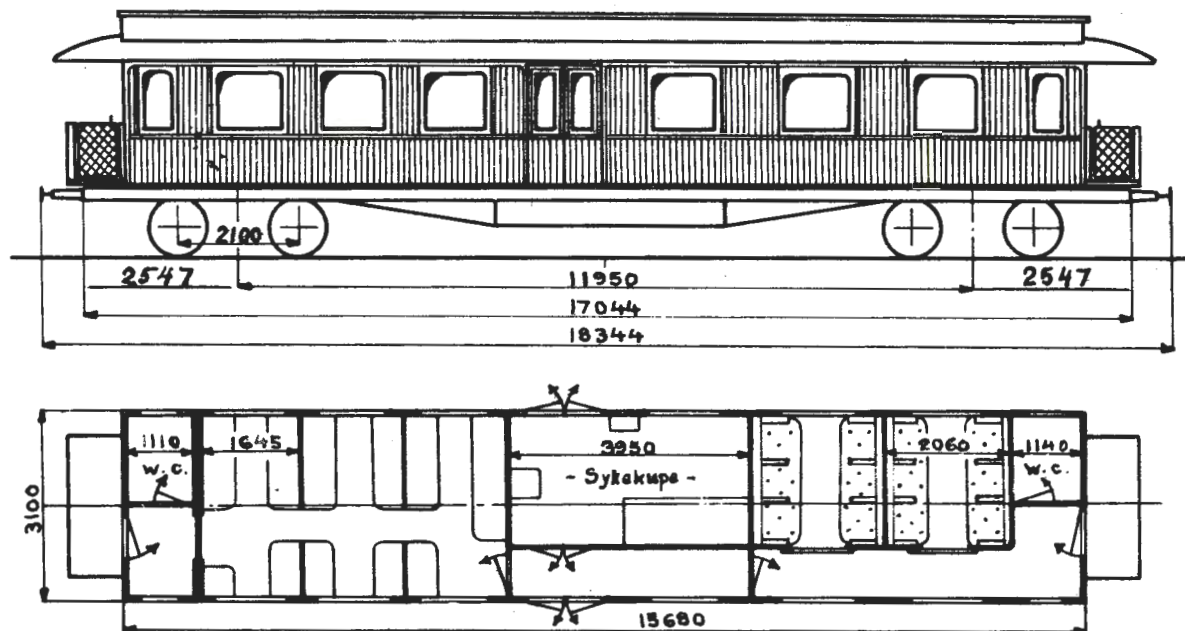

Hovedt. B. 438

Vogn nr.	Distriktsmerke	Fabrikant	Byggeår	Omtr. vognvekt i tonn	Sittepl. pr vogn		Grunnriss	El.varme i kW	Vognutstyr (se side 6)	Merknad
					1	2				
31	0	Skb	95	30,5	12	28			1H.3.5.8.11.39a	Ny vognkasse i 1919

ABZo2b

TYPE 2

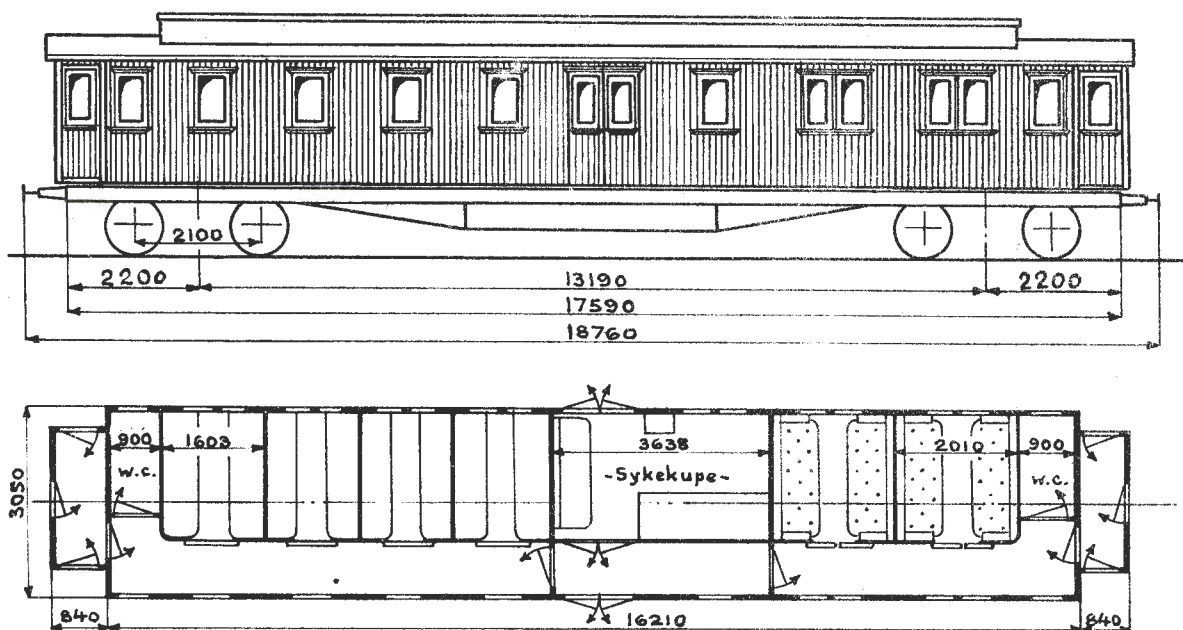

Oppr. hovedt. 469¹⁾

Vogn nr	Distriktsmerke	Fabrikant	Byggeår	Omr. vognvekt i tonn	Sittepl. pr vogn		Grunnriss	El. varme i kW	Vognutstyr (se side 6)	Merknad
					1	2				
844	T	Skb	01	26,5	12	32			1H.3.5.8.11.28	

1) Forandr. etter tegn. Tv. 1292
Trykk nr. 751 1.7.56

AFo2a

TYPE 1

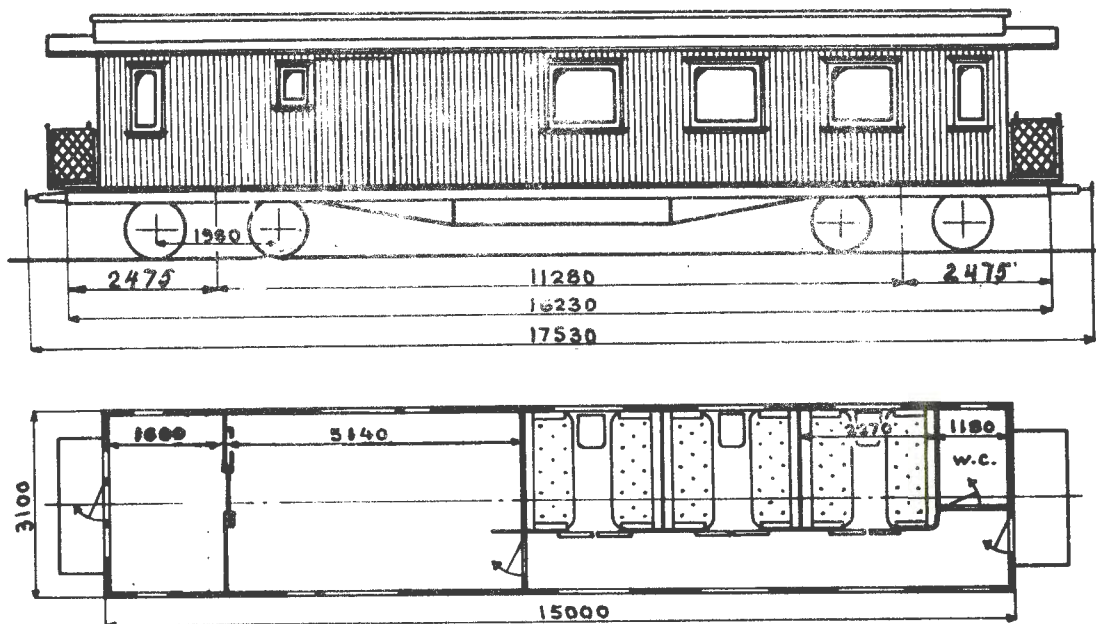

Oppr. hovedt. 7¹⁾

Vogn nr.	Distriktsmerke	Fabrikant	Byggeår	Omtrentlig vognvekt i tonn	Sittepl. 1. klasse	Grunnriss	El. varme i kW	Vognutstyr (se side 6)	Merknad
242	0	Skb	87	27,0	18			1H.3.5.11	

1) Forandr. etter tegn O.d. 1171
Trykk nr. 751 1.7.56

B3
 TYPE 1
 Stålvogner

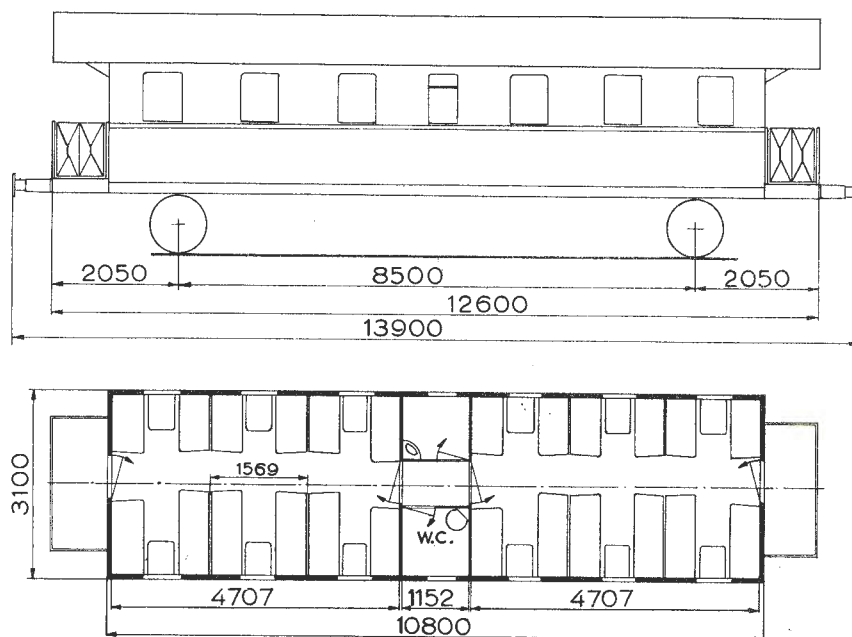

Hovedt. skisse 878

Vogn nr.	Distriktsmerke	Fabrikant	Byggeår	Omt. vognvekt i tonn	Sittepl. 2.klasse	Grunnriss	El. varme i kW	Vognutstyr (se side 6)	Merknad
19913	O			19,0	56			1H. 3. 5. 11. 24	
19914	D			"	"			1H. 3. 5. 11. 24	
19915	O			"	"			1H. 3. 5. 11.	
19916	"			19,5	"			1H. 3. 5. 11. 24	
19918	"			20,0	"			1H. 3. 5. 11. 24	
19919	"			19,0	"			1KK. 3. 5. 11	
19920	"			"	"			1H. 3. 5. 11	
19921	"			"	"			1KK. 3. 5. 11	

WLBo1a

TYPE 1

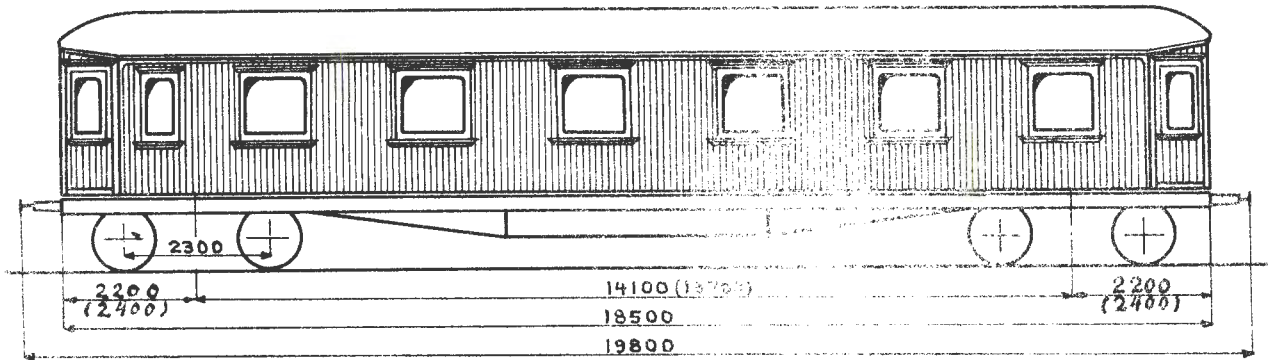

Mått (1) för vagnar efter teqn. 3140.

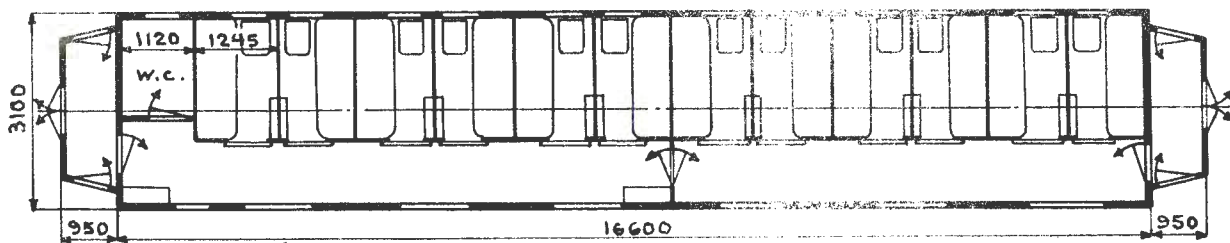

1304
Hovedt. 2249
3140

Vogn nr.	Distriktsmerke	Fabrikant	Byggeår	Omr. vognvekt i tonn	Sittepl. pr. vogn		Liggepl. pr. vogn		Grunnriis	El. varme i kW	Vognutstyr (se side 6)	Merknad
					1	2	1	2				
					klasse		klasse					
890	O	Str	12	37,0		48		36				Plattf.sidedörer slår ut
891	"	"	"	37,5	"	"	"	"				
983	B	"	13	37,0	"	"	"	"				Hovedt. 1304
984	"	"	"	35,5	"	"	"	"				
158	O	"	14	36,5	"	"	"	"				Plattf.sidedörer slår ut
159	"	"	"	"	"	"	"	"				
18005	T	"	"	35,5	"	"	"	"				Plattf.sidedörer slår ut
155	O	"	17	37,0	"	"	"	"				
152	"	"	20	36,5	"	"	"	"				Plattf.sidedörer slår ut
579	D	"	"	36,0	"	"	"	"				
996	B	"	"	"	"	"	"	"				Plattf.sidedörer slår ut
18056	D	"	"	38,0	"	"	"	"				
18063	"	"	"	37,0	"	"	"	"				Hovedt. 2249
786	H	Kok	21	35,5	"	"	"	"				
18102	T	"	"	36,5	"	"	"	"				Plattf.sidedörer slår ut
18103	"	"	"	35,5	"	"	"	"				
18116	B	Skb	25	37,0	"	"	"	"				Plattf.sidedörer slår ut
18117	"	"	"	"	"	"	"	"				
199	O	Str	30	37,5	"	"	"	"				Hovedt. 3140
200	"	"	"	38,0	"	"	"	"				

B3
TYPE 1
Stålvogner

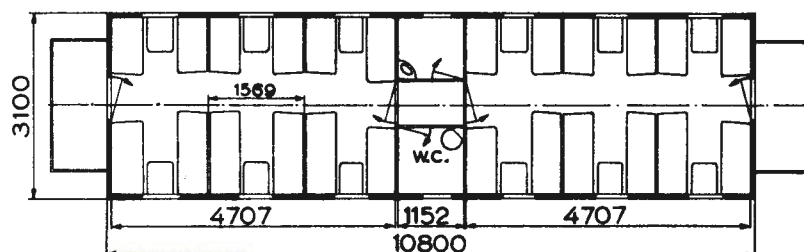
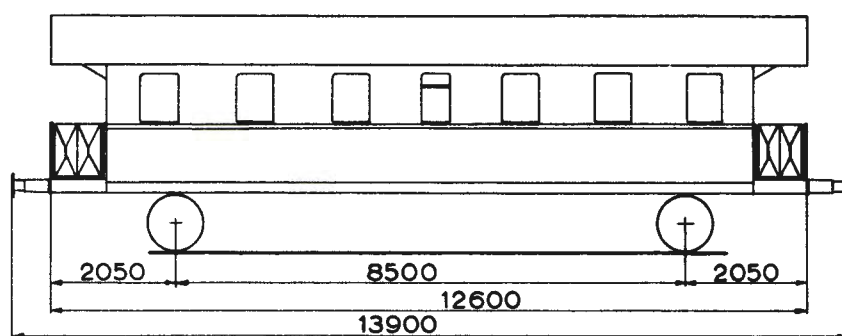

Hovedt. skisse 878

Vogn nr.	Distriktsmerke	Fabrikant	Byggeår	Omr. vognvekt i tonn	Sittepl. 2. klasse	Grunnriss	El. varme i kW	Vognutstyr (se side 6)	Merknad
19913	O		29	19,0	56			1H. 3. 5. 11. 24	
19914	D		"	"	"			1H. 3. 5. 11. 24	
19915	O		"	"	"			1H. 3. 5. 11.	
19916	"		"	19,5	"			1H. 3. 5. 11. 24	
19918	"		30	20,0	"			1H. 3. 5. 11. 24	
19919	"		"	19,0	"			1H. 3. 5. 11	
19920	"		"	"	"			1H. 3. 5. 11	
19921	"		"	"	"			1KK.3. 5. 11	

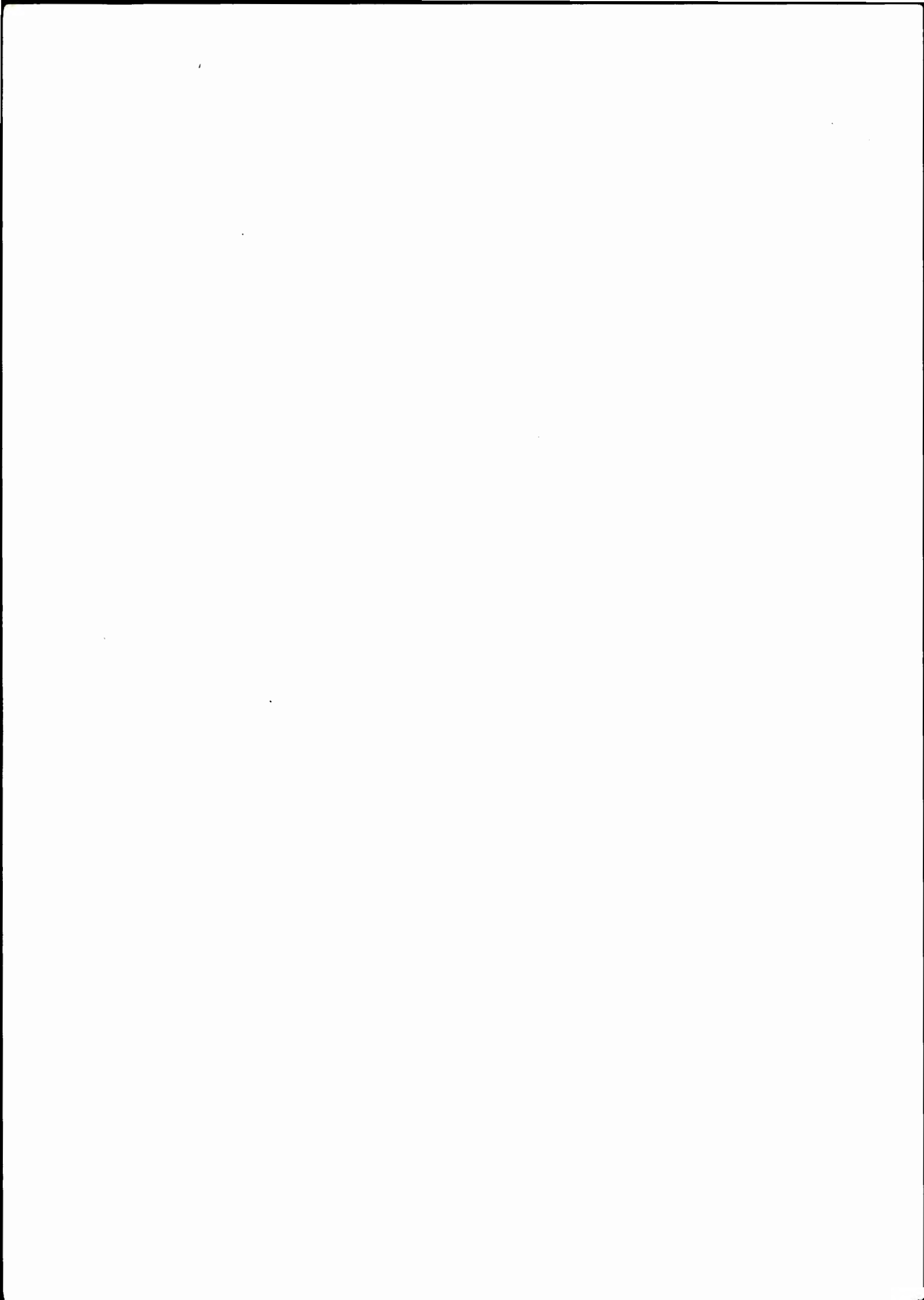

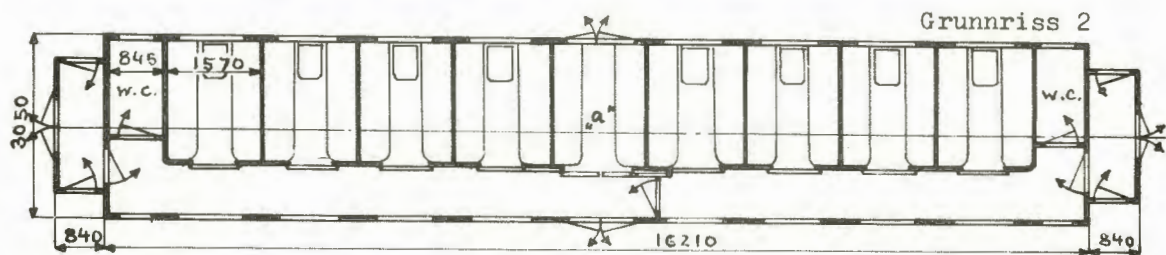
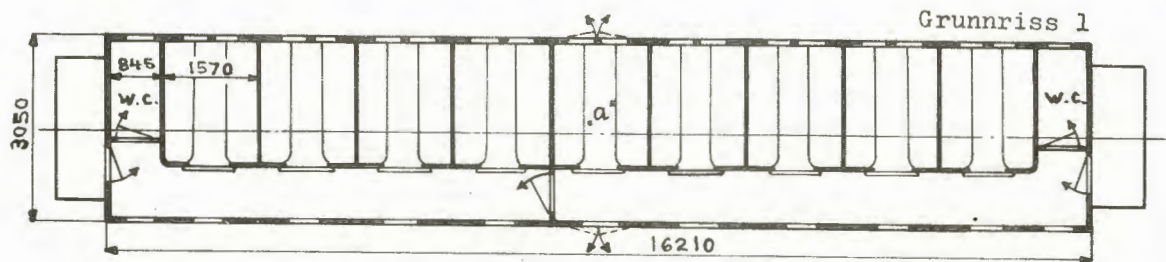
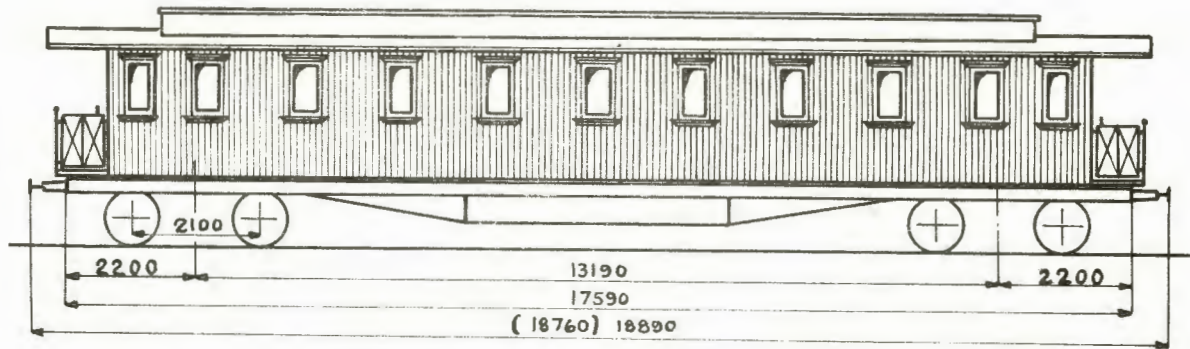

Hovedt. 439

Vogn nr.	Distriktsmerke	Fabrikant	Byggeår	Omr. vognvekt i tonn	Sittepl. 2.klasse	Grunnriss	El. varme i kW	Vognutstyr (se side 6)	Merknad
164	0	Str	01	25,0	72	1		1H.3.5.11	Sykekupé "a"
167	"	"	"	26,0	"	"		1H.3.5.11.39a	
168	"	"	"	24,5	"	"		1H.3.5.11	
327	"	"	00	24,5	"	"		1H.3.5.11	
328	"	"	"	25,0	"	"		1H.3.5.11	
329	"	"	01	25,0	"	"		1H.3.5.7.11	
330	"	"	"	28,0	"	"		1H.3.5.7.11	
331	"	"	"	25,5	"	"		1H.3.5.7.11	
332	"	"	"	24,5	"	"		1H.3.5.11	
333	"	"	"	"	"	"		1H.3.5.11	
334	"	"	"	25,0	"	"		1H.3.5.11	

Bo2a

TYPE 1

Vogn nr.	Distriktsmerke	Fabrikant	Byggeår	Omr. vognvekt i tonn	Sittepl. 2.klasse	Grunnriss	El. varme i kW	Vognutstyr (se side 6)	Merknad
335	0	Str	01	26,0	72	1		1H.3.5.11.39a	
336	"	"	"	24,0	"	"		1H.3.5.11	
337	"	"	"	26,0	"	"		1H.3.5.11	
835	T	"	00	28,0	"	2		1H.3.5.11.28	} Sykekupé "a"
841	"	Skb	01	"	"	"		1H.3.5.11.28	
842	"	"	"	24,5	"	1		1H.3.5.11	
843	"	"	"	25,0	"	"		1H.3.5.11	
849	"	Str	"	27,0	"	2		1H.3.5.11.28	} Sykekupé "a"
850	"	Skb	02	27,5	"	"		1H.3.5.11.28	
908	0	Str	00	25,5	"	1		1H.3.5.11	
909	"	"	"	26,0	"	"		1H.3.5.11	
910	"	"	01	27,0	"	"		1H.3.5.11	

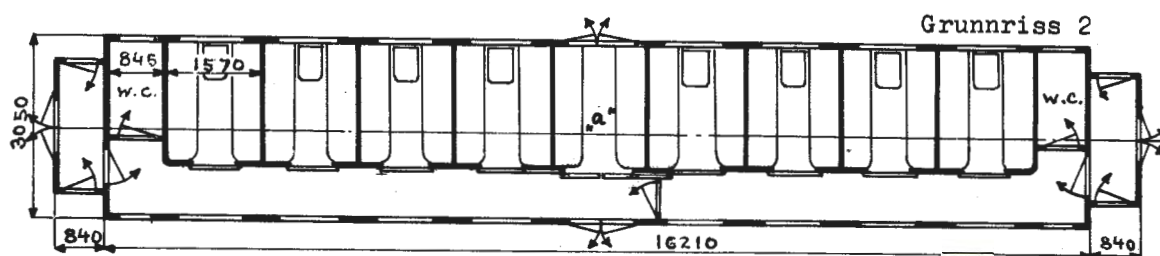
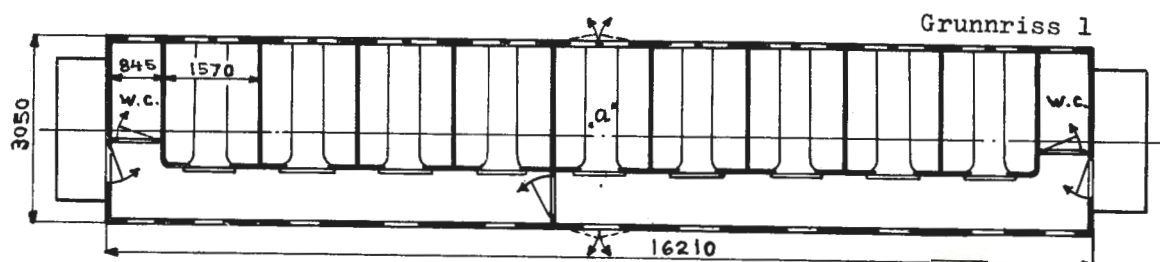
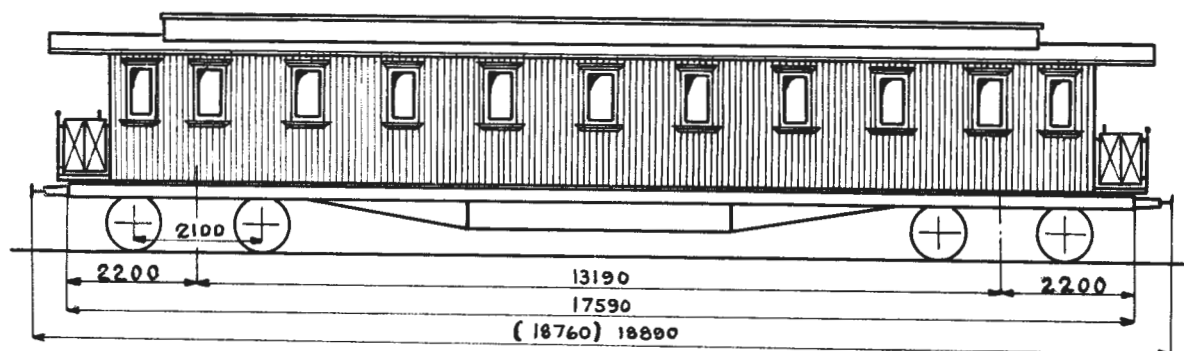

Hovedt. 439

Vogn nr.	Distriktsmerke	Fabrikant	Byggeår	Omr. vognvekt i tonn	Sittepl. 2.klasse	Grunnriss	El. varme i kW	Vognutstyr (se side 6)	Merknad
164	0	Str	01	25,0	72	1		1H.3.5.11	Sykekupé "a"
167	"	"	"	26,0	"	"		1H.3.5.11	
168	"	"	"	24,5	"	"		1H.3.5.11	
327	"	"	00	24,5	"	"		1H.3.5.11	
328	"	"	"	25,0	"	"		1H.3.5.11	
329	"	"	01	25,0	"	"		1H.3.5.7.11	
330	"	"	"	28,0	"	"		1H.3.5.7.11	
331	"	"	"	25,5	"	"		1H.3.5.7.11	
332	"	"	"	24,5	"	"		1H.3.5.11	
333	"	"	"	"	"	"		1H.3.5.11	
334	"	"	"	25,0	"	"		1H.3.5.11	

Bo2a

TYPE 1

Vogn nr.	Distriktsmerke	Fabrikant	Byggeår	Omr. vognvekt i tonn	Sittepl. 2.klasse	Grunnriss	El. varme i kW	Vognutstyr (se side 6)	Merknad
335	0	Str	01	26,0	72	1		1H.3.5.11	
336	"	"	"	24,0	"	"		1H.3.5.11	
337	"	"	"	26,0	"	"		1H.3.5.11	
835	T	"	00	28,0	"	2		1H.3.5.11.28	} Sykekupé "a"
841	"	Skb	01	"	"	"		1H.3.5.11.28	
842	"	"	"	24,5	"	1		1H.3.5.11	
843	"	"	"	25,0	"	"		1H.3.5.11	
849	"	Str	"	27,0	"	2		1H.3.5.11.28	} Sykekupé "a"
850	"	Skb	02	27,5	"	"		1H.3.5.11.28	
908	0	Str	00	25,5	"	1		1H.3.5.11	
909	"	"	"	26,0	"	"		1H.3.5.11	
910	"	"	01	27,0	"	"		1H.3.5.11	

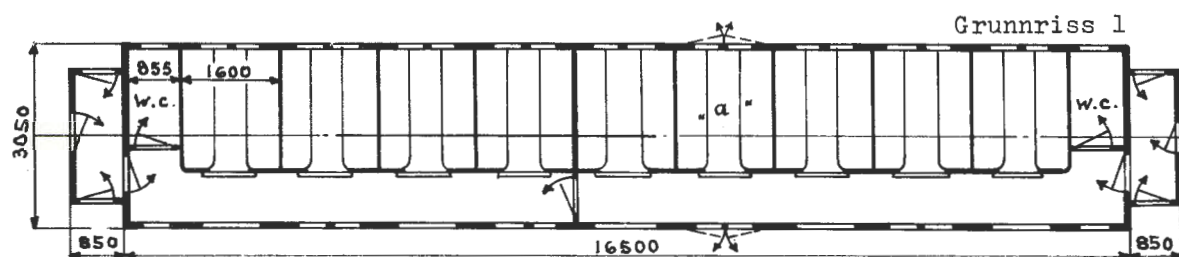
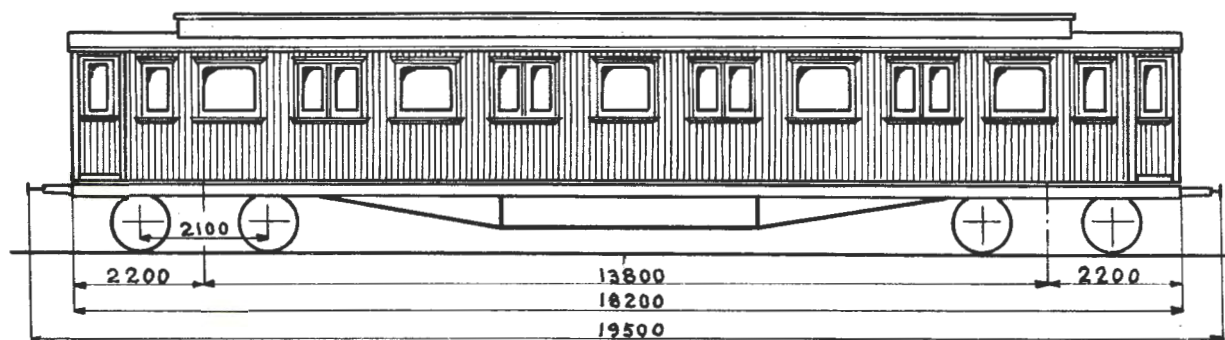

Hovedt. 695
813

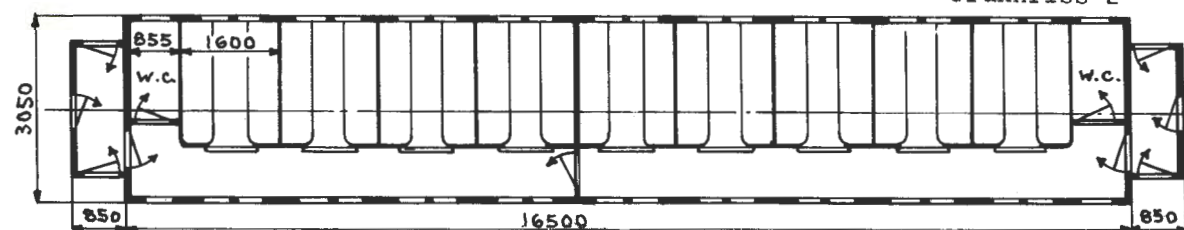

Grunnriss 2

Hovedt. 695

Vogn nr.	Distriktsmerke	Fabrikant	Byggeår	Omr. vognvekt i tonn	Sittepl. 2.klasse	Grunnriss	El. varme i kW	Vognutstyr (se side 6)	Merknad
509	D	Skb	09	27,5	72	1		1H.3.5.10.39a	Sykekupé "a"
510	"	"	"	30,0	"	"		1H.3.5.11.28.39a	
511	"	"	"	30,5	"	"		1H.3.5.11.28.39a	
931	B	Str	06	29,5	"	2		1H.3.5.11.28.39a	
932	"	"	"	30,0	"	"		1H.3.5.11.28.39a	
934	"	Skb	07	29,5	"	"		1H.3.5.11.28.39a	
935	"	"	08	28,0	"	1		1H.3.5.11.28.39a	
943	"	"	"	29,0	"	"		1H.3.5.11.28.39a	
957	"	"	04	29,5	"	2		1H.3.5.11	
958	"	"	"	28,5	"	"		1H.3.5.11.28.39a	
959	"	"	"	27,5	"	"		1H.3.5.11.28	

Bo2a

TYPE 2

Vogn nr.	Distriktsmerke	Fabrikant	Byggeår	Omr. vognvekt i tonn	Sittepl. 2.klasse	Grunnriss	El. varme i kW	Vognutstyr (se side 6)	Merknad
961	B	Str	04	29,0	72	2		1H.3.5.11.28.39a	
962	"	"	"	28,0	"	"		1H.3.5.10.28	

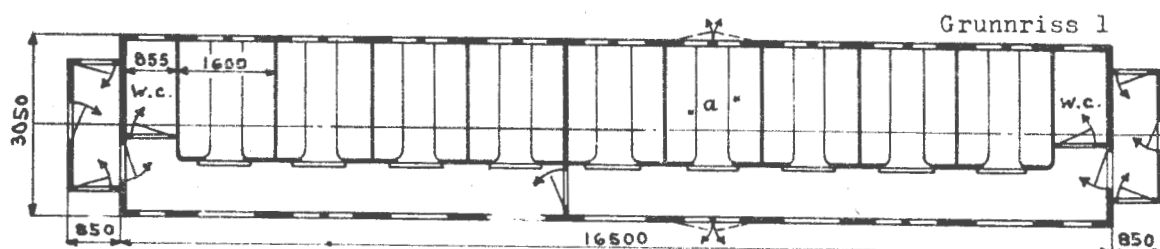
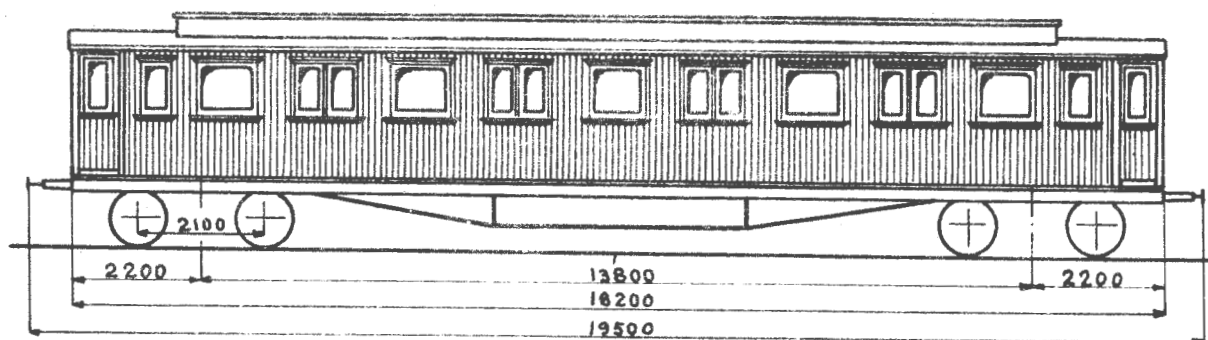

Hovedt. 695
813

Grunnriss 2

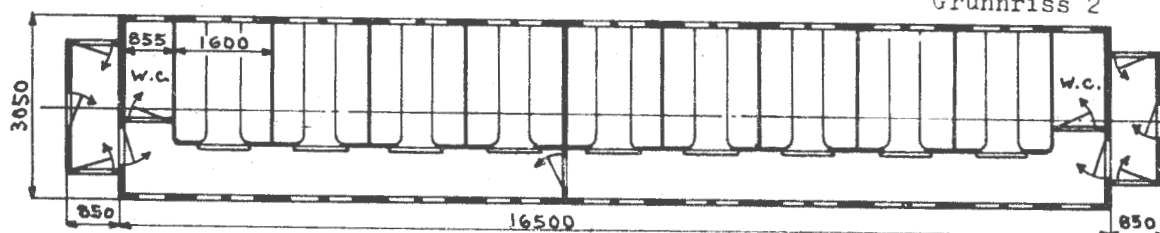

Hovedt. 695

Vogn nr.	Distriktsmerke	Fabrikant	Byggeår	Omtr. vognvekt i tonn	Sittepl. 2.klasse	Grunnriss	El.varme i kW	Vognutstyr (se side 6)	Merknad
509	D	Skb	09	27,5	72	1		1H.3.5.10.39a	Sykekupé "a"
510	"	"	"	30,0	"	"		1H.3.5.11.28.39a	
511	"	"	"	30,5	"	"		1H.3.5.11.28.39a	
931	B	Str	06	29,5	"	2		1H.3.5.11.28.39a	
932	"	"	"	30,0	"	"		1H.3.5.11.28.39a	
934	"	Skb	07	29,5	"	"		1H.3.5.11.28.39a	
935	"	"	08	28,0	"	1		1H.3.5.11.28.39a	
943	"	"	"	29,0	"	"		1H.3.5.11.28.39a	
957	"	"	04	29,5	"	2		1H.3.5.11.28.39a	
958	"	"	"	28,5	"	"		1H.3.5.11.28.39a	
959	"	"	"	27,5	"	"		1H.3.5.11.28.39a	

Bo2a

TYPE 2

Vogn nr.	Distriktsmerke	Fabrikant	Byggear	Omtr. vognvekt i tonn	Sittepl. 2.klasse	Grunnriss	El. varme i kW	Vognutstyr (se side 6)	Merknad
961	B	Str	04	29,0	72	2		1H.3.5.11.28.39a	
962	"	"	"	28,0	"	"		1H.3.5.10.28	

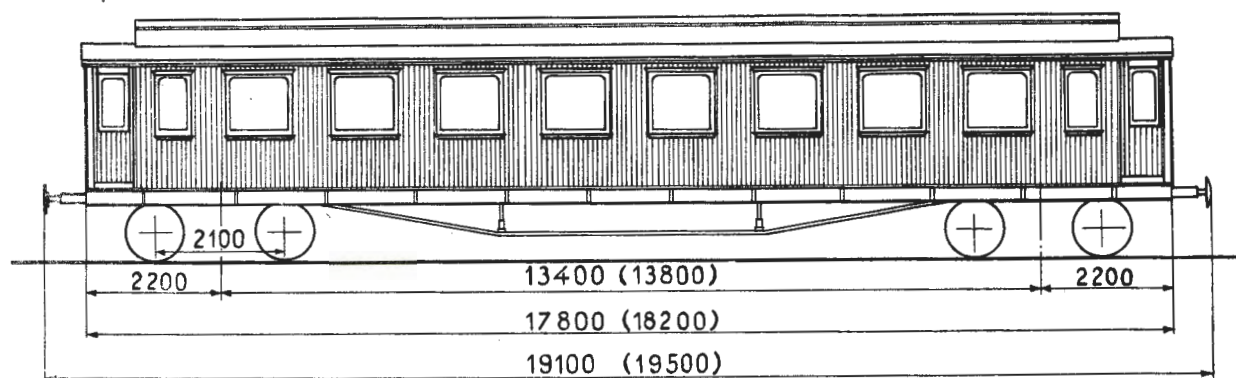

Mål i () gjelder for vogner etter grunnriss 2

Grunnriss 1

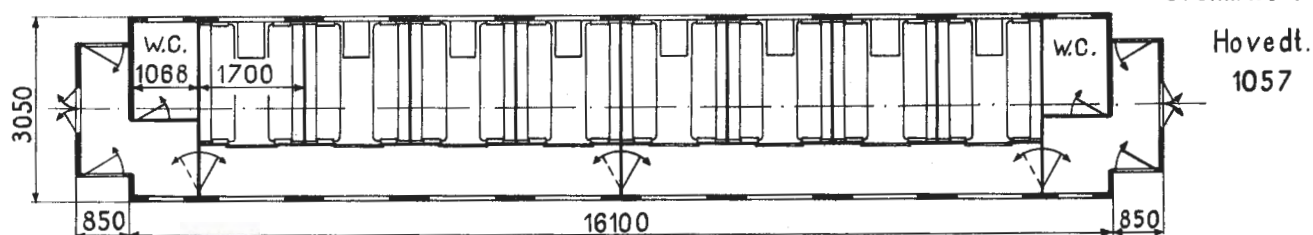
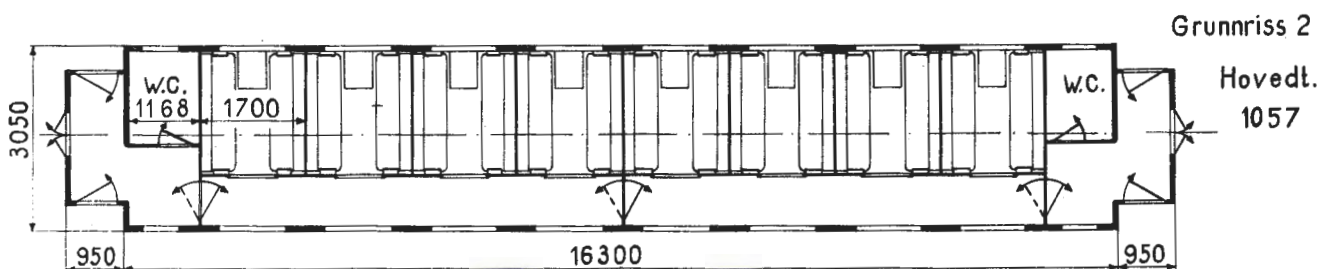
Hovedt.
1057

Grunnriss 2

Hovedt.
1057

Vogn nr.	Distriktsmerke	Fabrikant	Byggeår	Omtr. vognvekt i tonn	Sittepl. 2.klasse	Grunnriss	El. varme i kW	Vognutstyr (se side 6)	Merknad
476	O	Str	11	30,0	64	1		1H.3.5.11.28.39a	Ikke utvidet plattform
477	"	"	"	"	"	"		1H.3.5.11.28.39a	
539	D	Skb	"	30,5	"	"		1H.3.5.11.28.39a	Ikke utvidet plattform, ikke stål-rørseater.
540	"	"	"	30,0	"	"		1H.3.5.11.28.39a	
541	"	"	"	29,5	"	"		1H.3.5.11.28.39a	
769	H	"	"	25,0	"	"		1H.3.5.11.28.39a.41	
981	B	Str	"	30,5	"	2		1H.3.5.11.28.39a	
982	"	"	"	31,0	"	"		1H.3.5.11.28.39a	Ikke utvidet plattform

Bo2b

TYPE 2

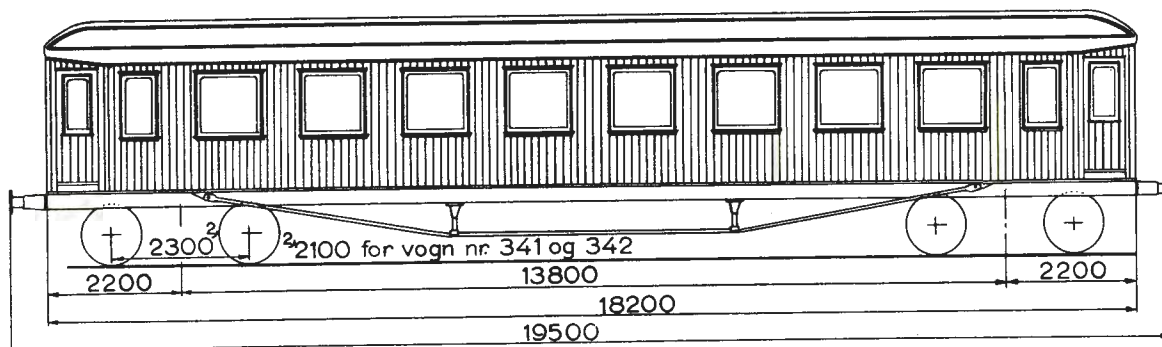

Grunnriss 1

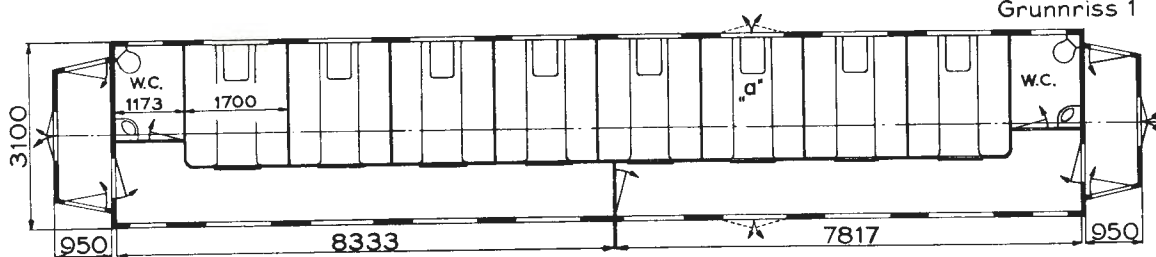

Grunnriss 2[↓]

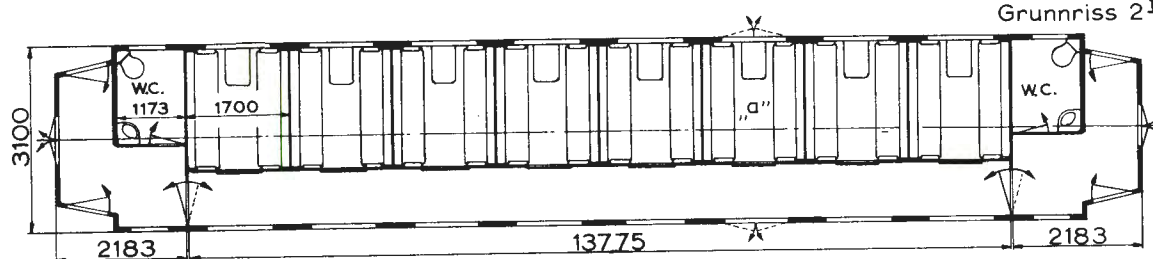

Hovedt. 2090
2120

Vogn nr.	Distriktsmerke	Fabrikant	Byggeår	Omtr. vognvekt i tonn	Sittepl. 2.klasse	Grunnriss	El. varme i kW	Vognutstyr (se side 6)	Merknad
153	O	Skb	20	32,5	64	1		1H. 3. 5. 11. 28. 39a	
154	"	"	"	31,5	"	"		1H. 3. 5. 11. 28. 39a	
156	"	Str	15	32,0	"	"		1H. 3. 5. 11. 28. 39a	
157	"	"	"	32,5	"	"		1H. 3. 5. 11. 28. 39a	
171	"	Skb	22	33,0	"	2		1H. 3. 5. 11. 28. 39a	
172	"	"	"	"	"	1		1H. 3. 5. 11. 28. 39a	
173	"	"	"	31,5	"	"		1H. 3. 5. 11. 28. 39a	
174	"	"	"	33,0	"	2		1H. 3. 5. 11. 28. 39a	
280	"	"	21	31,5	"	1		1KK. 3. 5. 11. 28. 39a	
281	"	"	"	37,5	"	"		1H. 3. 5. 11. 28. 39a	

[↓]Utvidet plattform etter tegn. 6559

Trykk nr. 751 1.7.57

Vogn nr.	Distriktsmerke	Fabrikant	Byggeår	Omtr. vognvekt i tonn	Sittepl. 2.klasse	Grunnriss	El. varme i kW	Vognutstyr (se side 6)	Merknad
282	0	Skb	21	33,5	64	2		1H.3.5.11.28.39a	
284	"	"	"	"	"	"		1KK.3.5.11.28.39a	
285	"	"	"	"	"	"		1KK.3.5.11.28.39a	
290	"	Kok	"	34,0	"	"		1KK.3.5.11.28.39a	Plattformsidedører slår ut
291	"	"	"	32,5	"	1		1KK.3.5.11.28.39a	
292	"	"	"	"	"	"		1KK.3.5.11.28.39a	
293	"	"	"	"	"	"		1KK.3.5.11.28.39a	
341	"	Str	12	29,5	64	2		1H.3.5.11.28.39a	2)
342	"	"	"	"	"	1		1H.3.5.11.39a	2)
343	"	"	15	32,5	"	2		1H.3.11.39a	
344	"	"	"	32,0	"	"		1H.3.5.11.28.39a	
345	"	Skb	17	32,5	"	1		1H.3.5.11.39a	
346	"	"	"	34,0	"	"		1H.3.5.11.28.39a	
347	"	"	20	33,0	"	"		1H.3.5.11.39a	
563	D	Str	15	31,5	"	"		1H.3.5.10.39a	
564	"	"	"	32,5	"	2		1H.3.5.11.28.39a	
565	"	"	"	31,5	"	"		1H.3.11.39a	
566	"	"	"	33,5	"	"		1H.3.5.11.39a	
567	"	"	"	34,0	"	"		1H.3.5.11.28.39a	
568	"	Skb	"	33,0	"	"		1H.3.5.11.39a	
569	"	"	"	32,0	"	"		1H.3.11.28.39a	
570	"	"	"	32,5	"	"		1H.3.5.11.28.39a	
571	"	"	"	"	"	"		1H.3.11.28.39a	
572	"	"	"	34,0	"	"		1H.3.5.11.28.39a	
580	"	"	21	33,5	"	"		1H.3.5.11.28.39a	
623	"	"	22	"	"	"		1H.3.5.11.28.39a	
637	"	Str	24	33,0	"	1		1H.3.5.11.28.39a	
638	"	"	"	"	"	2		1H.3.5.11.39a	
639	"	"	"	34,0	"	"		1H.3.5.11.28.39a	
640	"	"	"	33,5	"	"		1H.3.5.11.28.39a	
744	H	"	25	32,5	"	"		1H.3.5.11.28.39a	
745	"	"	"	31,5	"	1		1H.3.5.11.28.39a	
770	"	Skb	17	32,0	"	2		1H.3.5.11.28.39a	
771	"	"	18	31,5	"	1		1H.3.5.11.28.39a	
782	"	"	15	32,0	"	"		1H.3.5.11.28.39a	
783	"	"	"	31,0	"	"		1H.3.5.11.28.39a	
876	0	"	21	31,5	"	"		1H.3.5.11.39a	
877	"	Str	19	"	"	"		1H.3.5.11.39a	
878	"	"	"	31,0	"	"		1H.3.5.11.28.39a	
880	"	Skb	20	"	"	"		1H.3.5.10.28.39a	
884	"	"	18	34,0	"	2		1H.3.5.11.28.39a	Sykekupé "a"
885	"	"	19	31,5	"	"		1H.3.5.11.28.39a	" "

2) Hovedt. 2090

Trykk nr. 751 1.7.57

Bo2b

TYPE 2

Vogn nr.	Distriktsmerke	Fabrikant	Byggeår	Omtr. vognvekt i tonn	Sittepl. 2.klasse	Grunnriss	El. varme i kW	Vognutstyr (se side 6)	Merknad
✓ 18012	T	Skb	15	32,5	64	1		1H.3.5.11.28	
✓ 18013	"	"	"	"	"	"		1H.3.5.11.28.39a	
✓ 18014	"	"	"	32,0	"	2		1H.3.5.11.28	
✓ 18026	D	Str	"	33,5	"	"		1H.3.5.11.28.39a	
✓ 18027	"	"	"	"	"	1		1H.3.5.11.28.39a	
✓ 18028	"	"	16	"	"	2		1H.3.5.11.39a	
✓ 18037	T	Skb	18	33,0	"	"		1H.3.5.11.28	
✓ 18042	"	"	"	34,0	"	"		1H.3.5.11.28.39a	
✓ 18057	D	"	21	"	"	"		1H.3.5.11.28.39a	
✓ 18058	"	"	"	32,5	"	1		1H.3.5.11.39a	
✓ 18062	"	"	"	34,5	"	2		1H.3.5.11.28.39a	
✓ 18099	B	Kok	"	33,0	"	1		1H.3.5.11.28.39a	

Vogn nr.	Distriktsmerke	Fabrikant	Byggeår	Omtr. vognvekt i tonn	Sittepl. 2.klasse	Grunnriss	Elvarme i kW	Vognutstyr (se side 6)	Merknad
282	0	Skb	21	33,5	64	2		1H.3.5.11.28.39a	
284	"	"	"	"	"	"		1KK.3.5.11.28.39a	
285	"	"	"	"	"	"		1KK.3.5.11.28.39a	
290	"	Kok	"	34,0	"	"		1KK.3.5.11.28.39a	2)
291	"	"	"	32,5	"	1		1KK.3.5.11.28.39a	
292	"	"	"	33,0	"	2		1H.3.5.11.28.39a	
293	"	"	"	"	"	1		1KK.3.5.11.28.39a	
341	"	Str	12	29,5	"	2		1H.3.5.11.28.39a	3)
342	"	"	"	"	"	1		1H.3.5.11.39a	3)
343	"	"	15	32,5	"	2		1H.3.11.39a	
344	"	"	"	32,0	"	"		1H.3.5.11.28.39a	
345	"	Skb	17	32,5	"	1		1H.3.5.11.39a	
346	"	"	"	34,0	"	"		1H.3.5.11.28.39a	
347	"	"	20	33,0	"	"		1H.3.5.11.39a	
563	D	Str	15	33,5	"	2		1H.3.5.11.28.39a	
564	"	"	"	32,5	"	"		1H.3.5.11.28.39a	
565	"	"	"	31,5	"	"		1H.3.11.39a	
566	"	"	"	33,5	"	"		1H.3.5.11.39a	
567	"	"	"	34,0	"	"		1H.3.5.11.28.39a	
568	"	Skb	"	33,0	"	"		1H.3.5.11.39a	
569	"	"	"	32,0	"	"		1H.3.11.28.39a	
570	"	"	"	32,5	"	"		1H.3.5.11.28.39a	
571	"	"	"	"	"	"		1H.3.11.28.39a	
572	"	"	"	34,0	"	"		1H.3.5.11.28.39a	
580	"	"	21	33,5	"	"		1H.3.5.11.28.39a	
623	"	"	22	"	"	"		1H.3.5.11.28.39a	
637	"	Str	24	33,0	"	1		1H.3.5.11.28.39a	
638	"	"	"	"	"	2		1H.3.5.11.39a	
639	"	"	"	33,5	"	"		1H.3.5.11.28.39a	
640	"	"	"	"	"	"		1H.3.5.11.28.39a	
744	H	"	25	32,5	"	"		1H.3.5.11.28.39a	
745	"	"	"	31,5	"	1		1H.3.5.11.28.39a	
770	"	Skb	17	32,0	"	2		1H.3.5.11.28.39a	
771	"	"	18	31,5	"	1		1H.3.5.11.28.39a	
782	"	"	15	32,0	"	"		1H.3.5.11.28.39a	
783	"	"	"	31,0	"	"		1H.3.5.11.28.39a	
876	0	"	21	33,5	"	2		1H.3.5.11.28.39a	
877	"	Str	19	33,0	"	"		1H.3.5.11.28.39a	
878	"	"	"	31,0	"	1		1H.3.5.11.28.39a	
880	"	Skb	20	"	"	"		1H.3.5.10.28.39a	
884	"	"	18	34,0	"	2		1H.3.5.11.28.39a	4)
885	"	"	19	31,5	"	"		1H.3.5.11.28.39a	

2) Plattformsidedører slår ut

3) Hovedt. 2090

4) Sykekupé "a"

Trykk nr. 751 1.7.58

Bo2b

TYPE 2

Vogn nr.	Distriktsmerke	Fabrikant	Byggeår	Omtr. vognvekt i tonn	Sittepl. 2. Klasse	Grunnriss	El. varme i kW	Vognutstyr (se side 6)	Merknad
18012	T	Skb	15	32,5	64	1		1H.3.5.11.28	
18013	"	"	"	"	"	2		1H.3.5.11.28.39a	
18014	"	"	"	32,0	"	"		1H.3.5.11.28	
18026	D	Str	"	33,5	"	"		1H.3.5.11.28.39a	
18027	"	"	"	"	"	1		1H.3.5.11.28.39a	
18028	"	"	16	"	"	2		1H.3.5.11.39a	
18037	T	Skb	18	33,0	"	"		1H.3.5.11.28	
18042	"	"	"	34,0	"	"		1H.3.5.11.28.39a	
18057	D	"	21	"	"	"		1H.3.5.11.28.39a	
18058	"	"	"	32,5	"	1		1H.3.5.11.39a	
18062	"	"	"	34,5	"	2		1H.3.5.11.28.39a	
18099	B	Kok	"	33,0	"	1		1H.3.5.11.28.39a	

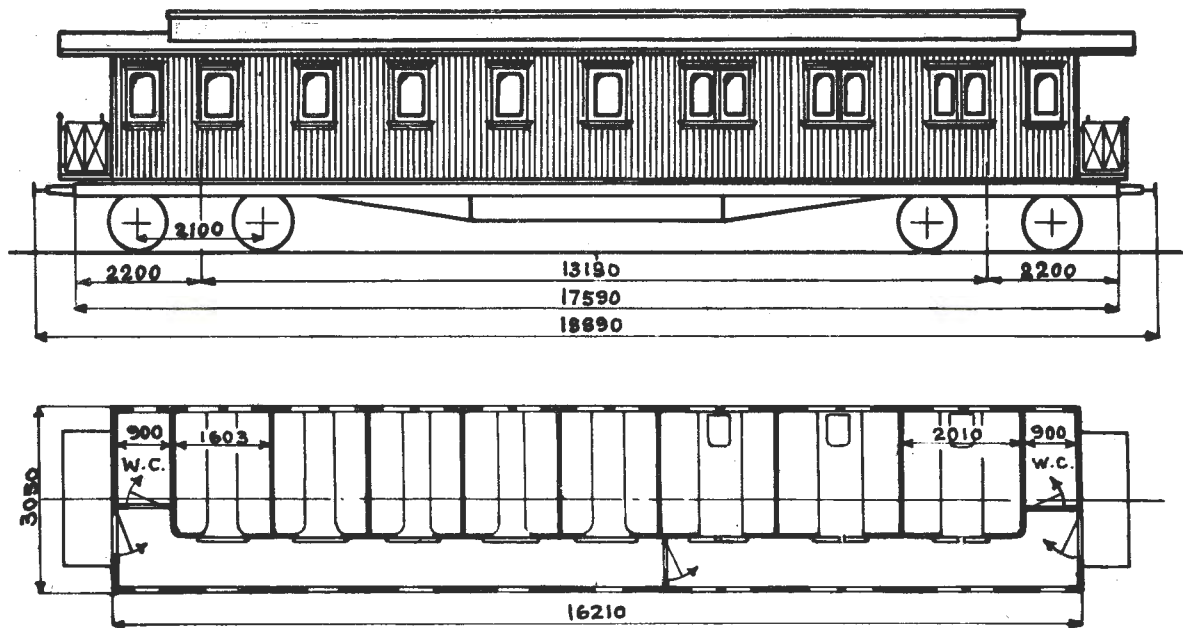

Hovedt. 469

Vogn n.:	Distriktsmerke	Fabrikant	Byggeår	Omt. vognvekt i tonn	Sittepl. 2.klasse	Grunnriss	El.varme i kW	Vognutstyr (se side 6)	Merknad
902	0	Skb	00	27,0	64	1		1H.3.5.11	
903	"	"	"	26,0	"	"		1H.3.5.11	
737	H	"	01	27,0	"	"		1H.3.5.11	

Bo2b

TYPE 6

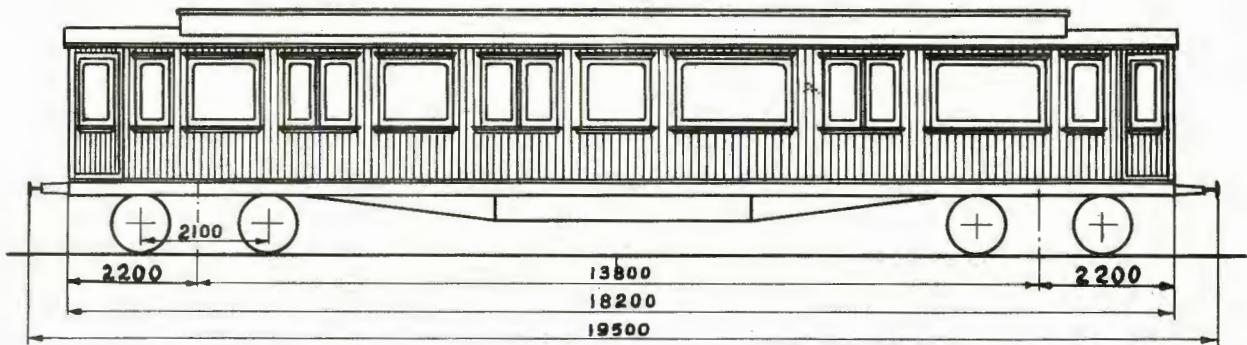

Grunnriss 1

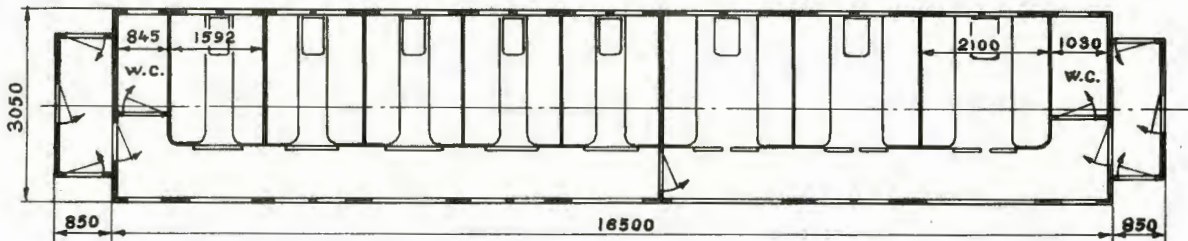

Hovedt
oppr. 699
+ 869

Grunnriss 2

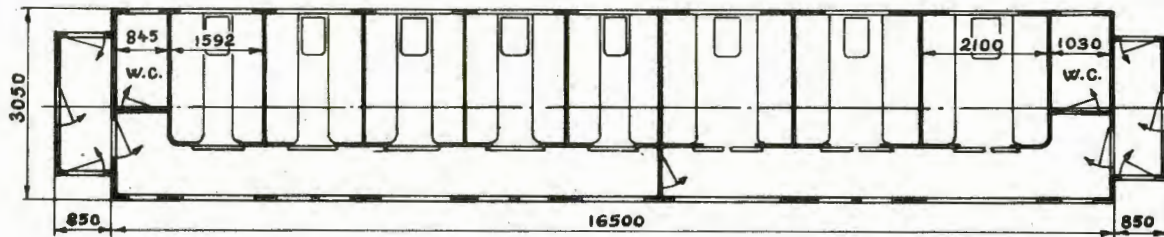

Hovedt,
oppr. 699
+ 869

Vogn nr.	Distriktsmerke	Fabrikant	Byggeår	Omtr. vognvekt i tonn	Sittepl. 2.klasse	Grunnriss	El.varme i kW	Vognutstyr (se side 6)	Merknad
503	D	Str	09	30,0	64	2		1H.3.5.11.28.39a	
505	"	"	"	28,0	"	1		1H.3.5.11.28.39a	
506	"	"	"	30,0	"	2		1H.3.5.11.28.39a	
507	"	"	"	30,5	"	"		1H.3.5.11.28.39a	Dobbelte plattformendedører
508	"	"	"	"	"	1		1H.3.5.11.28.39a	
918	O	Skb	08	29,0	"	2		1H.3.5.11.39a	Dobbelte plattformendedører
923	B	Str	05	30,5	"	"		1H.3.5.11.28.39a	
956	"	"	04	29,5	"	"		1H.3.5.11.28.39a	

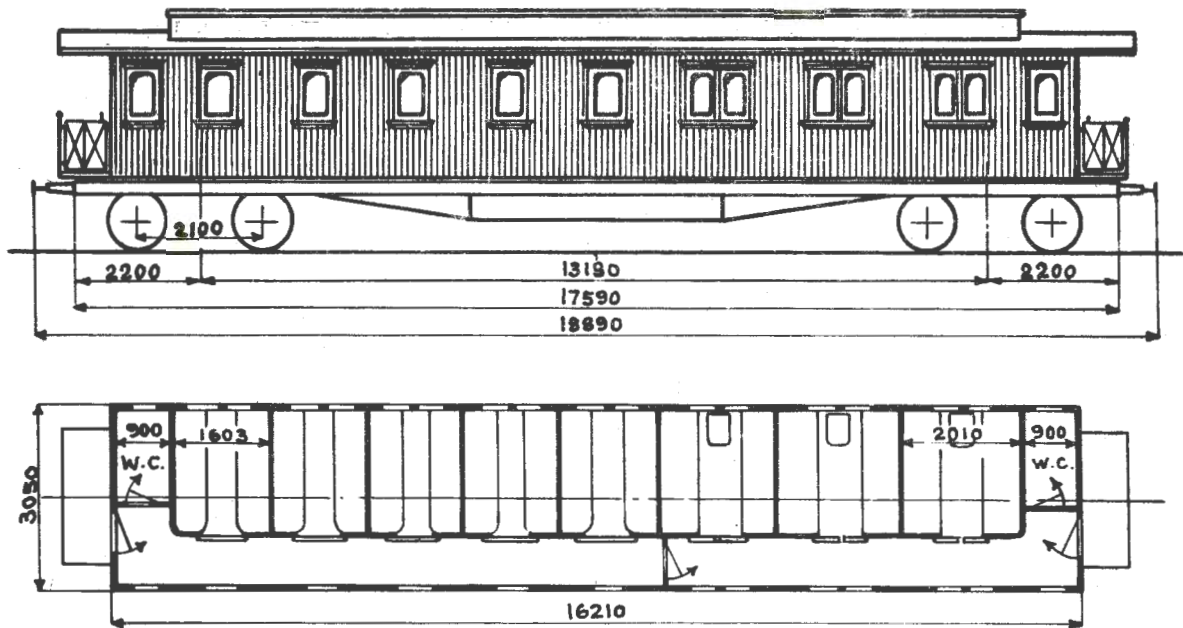

Hovedt. 469

Vogn nr.	Distriktsmerke	Fabrikant	Byggeår	Omtr. vognvekt i tonn	Sittepl. 2.klasse	Grunnriss	El. varme i kW	Vognutstyr (se side 6)	Merknad
902	0	Skb	00	27,0	64	1		1H.3.5.11	
903	"	"	"	26,0	"	"		1H.3.5.11	
737	H	"	01	27,0	"	"		1H.3.5.11	

Bo2b

TYPE 6

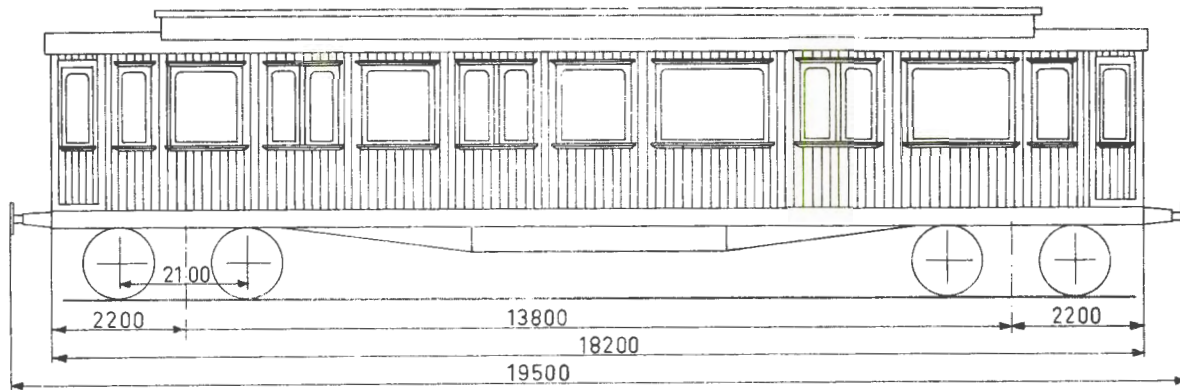

Grunnriss 1

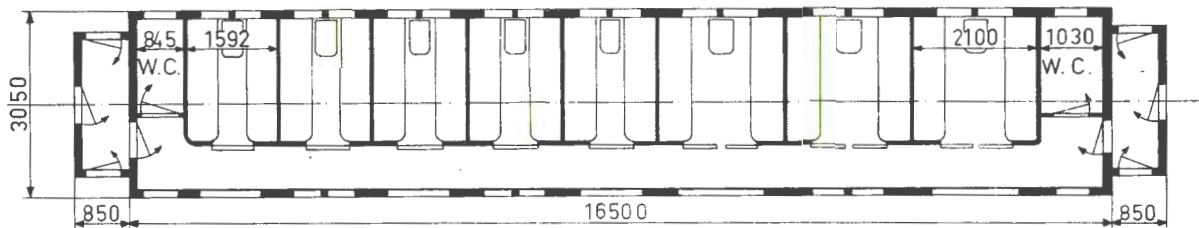

Grunnriss 2

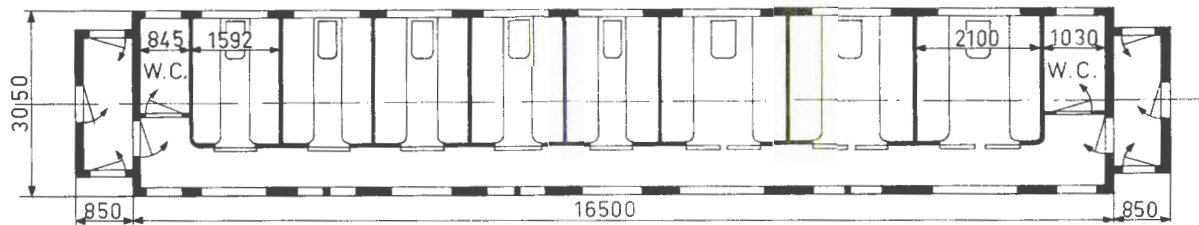

Grunnriss 3

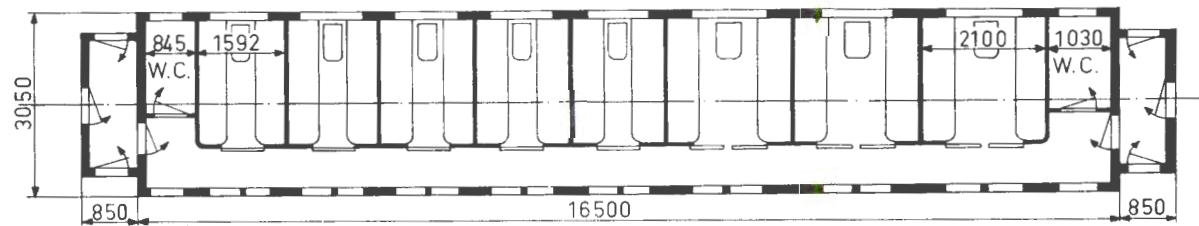

Hovedt. oppr. 699-869

Vogn nr.	Distriktsmerke	Fabrikant	Byggeår	Omr. vognvekt i tonn	Sittepl. 2. klasse	Grunnriss	EL varme i kW	Vognutstyr (se side 6)	Merknad
503	D	Str	09	30,0	64	2		1H.3.5.11.28.39a	
505	"	"	"	28,0	"	1		1H.3.5.11.28.39a	
506	"	"	"	30,0	"	2		1H.3.5.11.28.39a	
507	"	"	"	"	"	"		1H.3.5.11.28.39a	
508	"	"	"	"	"	1		1H.3.5.11.28.39a	1)2)
918	O	Skb	08	29,0	"	2		1H.3.5.11.39a	1)
921	H	"	05	28,5	"	3		1H.3.5.11.39a	2)
923	B	Str	"	30,5	"	2		1H.3.5.11.28.39a	
925	"	"	08	29,5	"	1		1H.3.5.11.28.39a	

1) Brede enkeltvinduer på begge vognsider

2) Dobbelte plattformendedører

Vogn nr.	Distriktsmerke	Fabrikant	Byggeår	Omr. vognvekt i tonn	Sittepl. 2.klasse	Grunnriss	El. varme i kW	Vognutstyr (se side 6)	Merknad
927	B	Str	08	29,0	64	1		1H.3.5.11.28.39a	
955	H	"	04	29,5	"	3		1H.3.5.11.28.39a	
956	B	"	"	"	"	2		1H.3.5.11.28.39a	

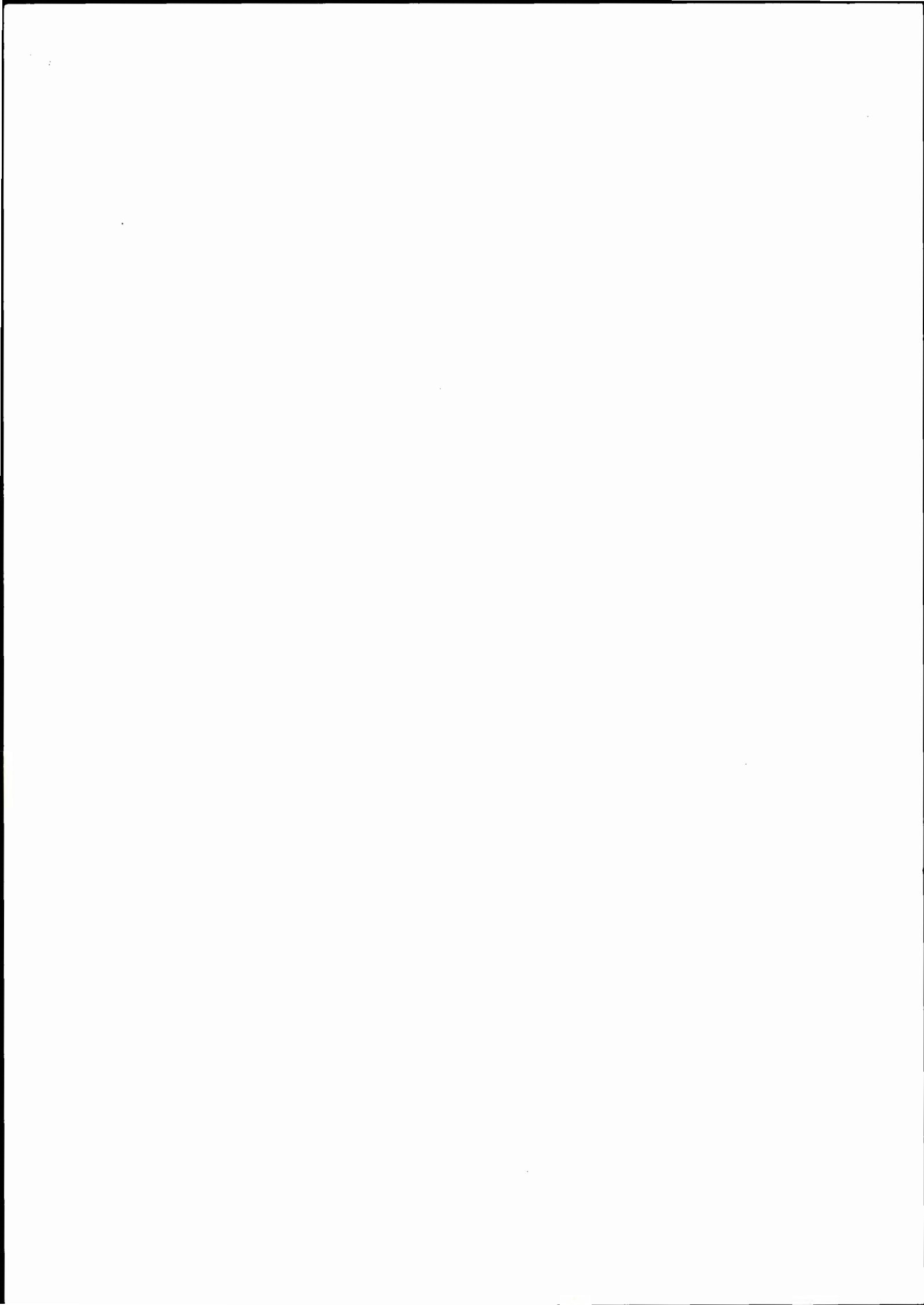

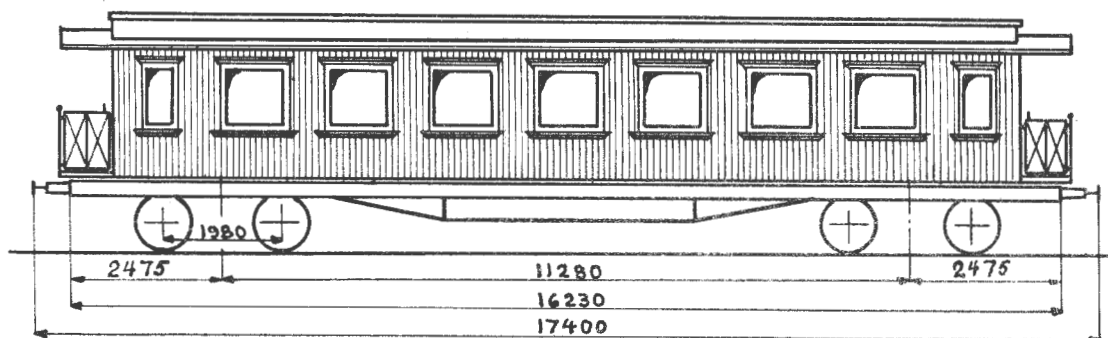

Grunnriss 1

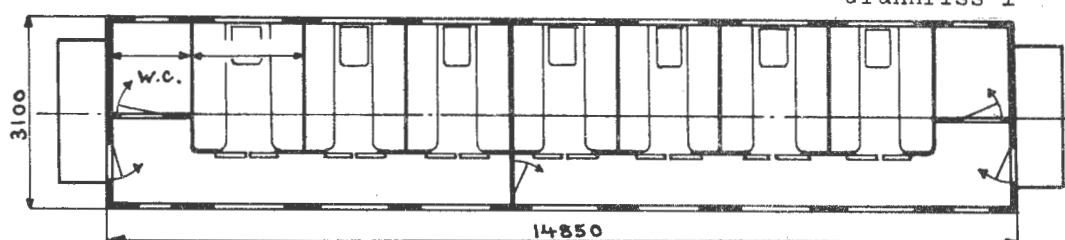

Oppr. hovedt. 312b

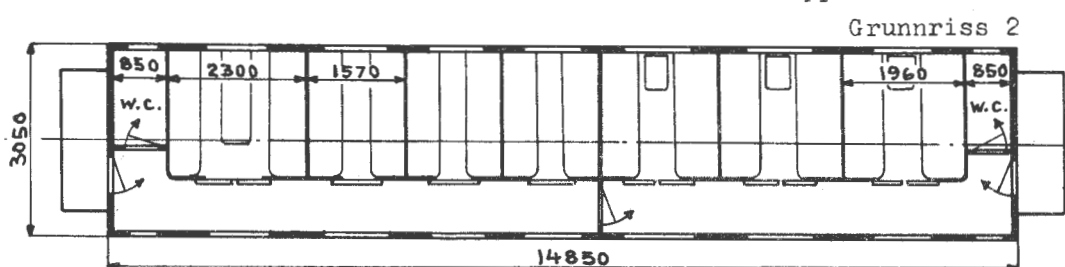
Oppr. hovedt. 205¹⁾

Vogn nr.	Distriktsmerke	Fabrikant	Byggeår	Omr. vognvekt i tonn	Sittepl. 2.klasse	Grunnriss	El.varme i kW	Vognutstyr (se side 6)	Merknad
131	0	At1	93	24,5	56	2		1H.3.5.10	
762	B	Str	94	26,0	"	1		1H.3.5.10	

1) Forandr. etter O.d. tegn. 866

Bo2c

TYPE 2

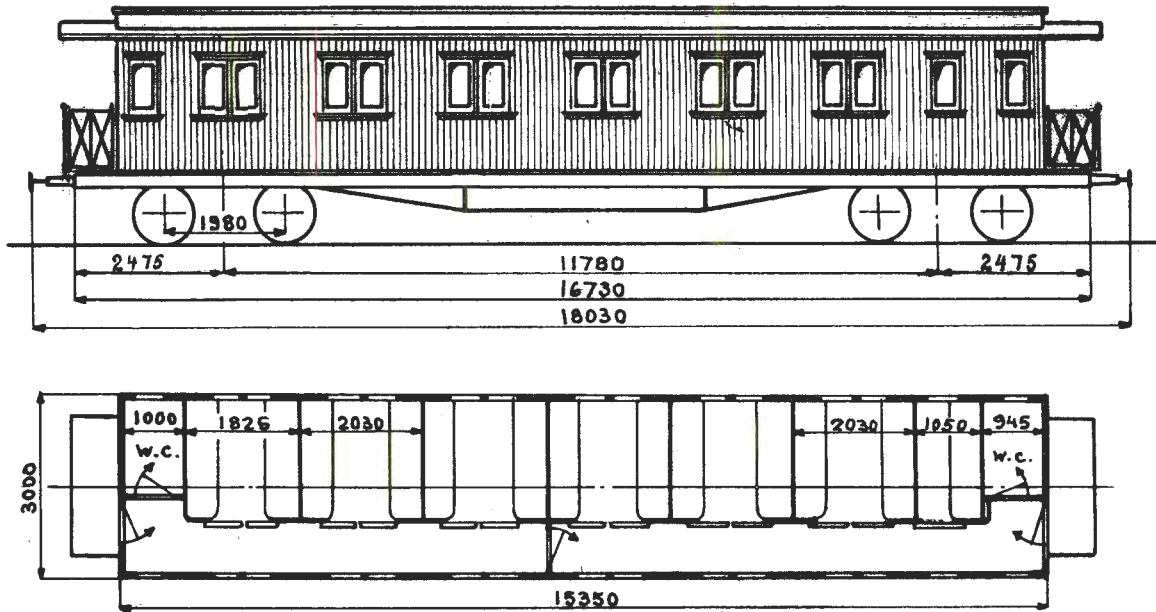

Oppr. hovedt. 366

Vogn nr.	Distriktsmerke	Fabrikant	Byggear	Omtr. vognvekt i tonn	Sittepl. 2.klasse	Grunnriss	El. varme i kW	Vognutstyr (se side 6)	Merknad
125	0	Str	98	24,0	52			1H.3.5.10	

Bo2c

TYPE 3

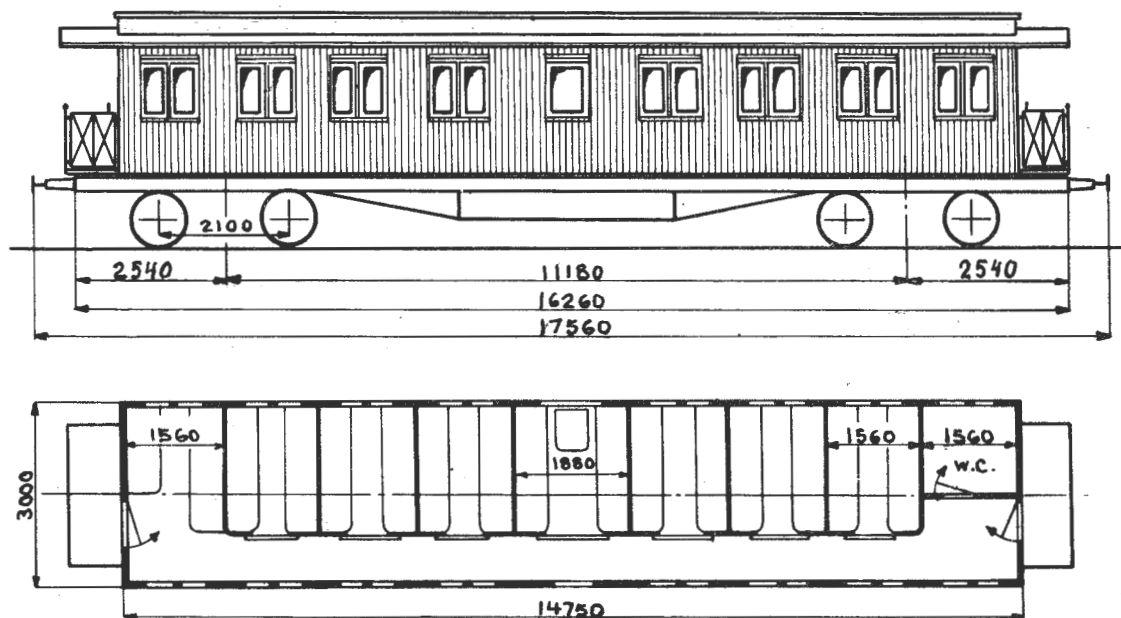

Hovedt. B. 65

Vogn nr.	Distriktsmerke	Fabrikant	Byggeår	Omr. vognvekt i tonn	Sittepl. 2.klasse	Grunnriss	El.varme i kW	Vognutstyr (se side 6)	Merknad
66	0	Str	99	23,0	63			1H.3.5.11	

Bo2c

TYPE 4

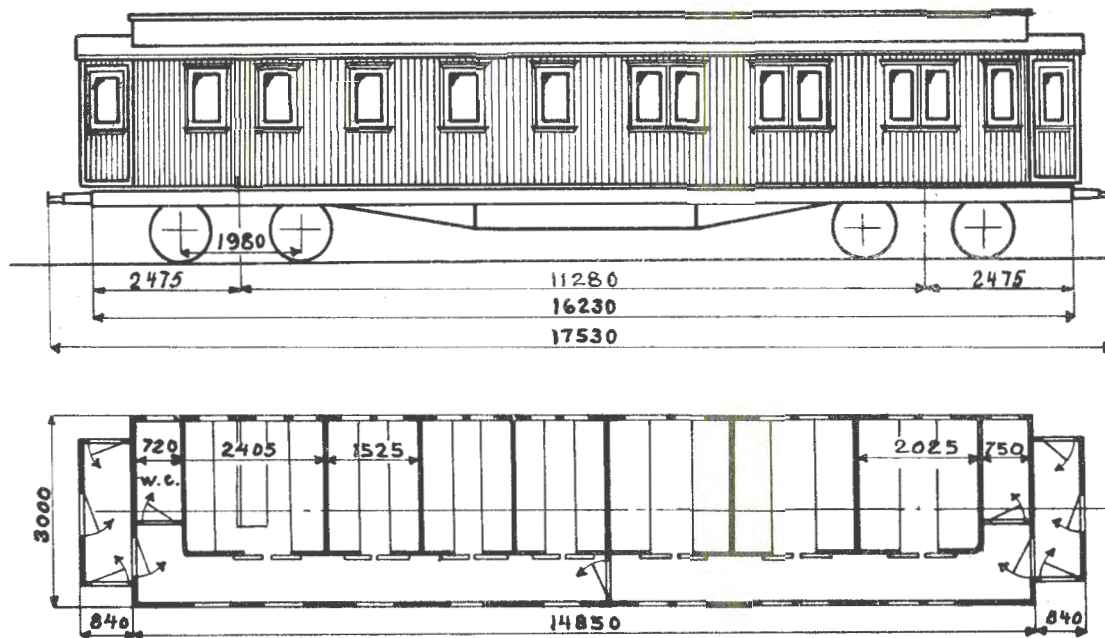

Oppr. hovedt. 367

Vogn nr.	Distriktsmerke	Fabrikant	Byggeår	Omr. vognvekt i tonn	Sittepl. 2.klasse	Grunnriss	El.varme i kW	Vognutstyr (se side 6)	Merknad
901	0	Skb	97	23,0	59			1H.3.5.13	

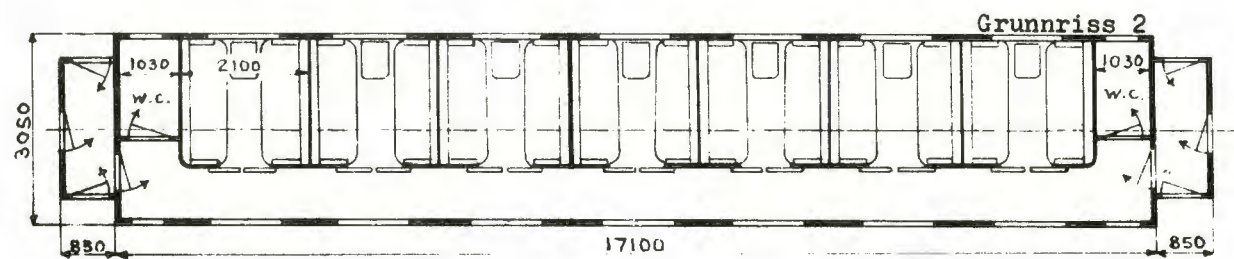
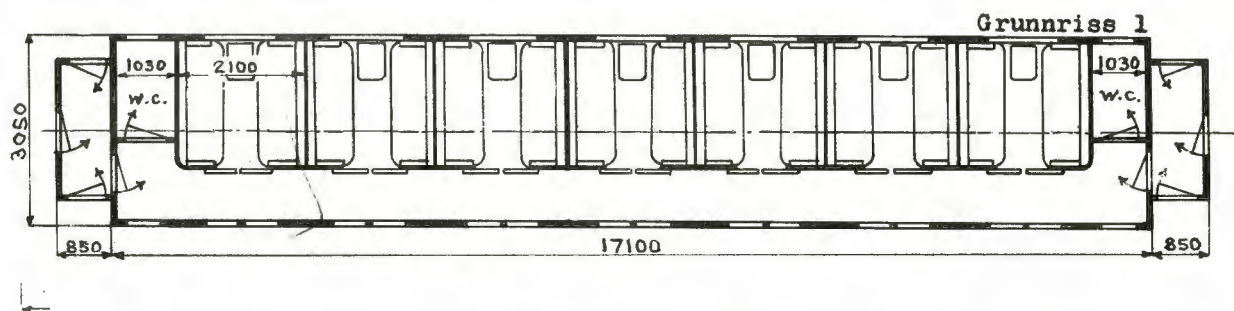
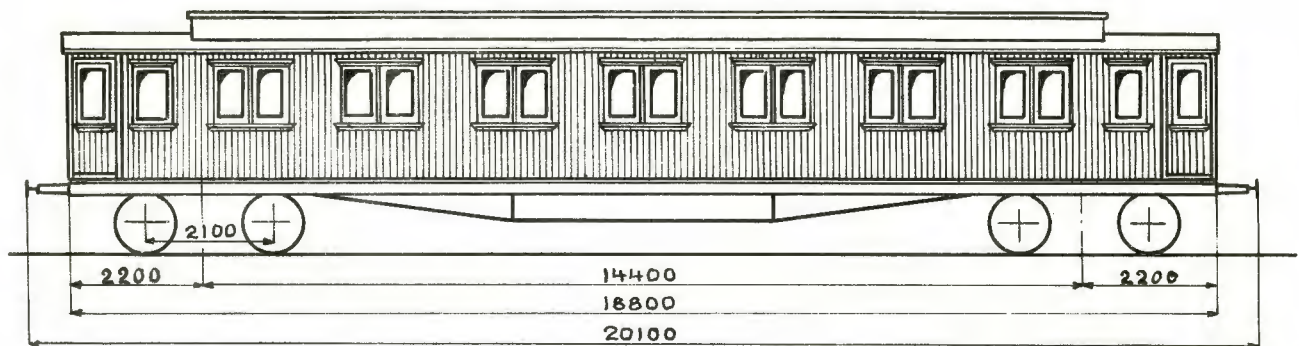

Oppr. hovedt. 700

Vogn nr.	Distriktsmerke	Fabrikant	Byggeår	Omtrentlig vognvekt i tonn	Sittepl. 2.klasse	Grunnriss	El. varme i kW	Vognutstyr (se side 6)	Merknad
928	B	Skb	05	29,5	56	1		1H.3.5.11.28.39a	
929	"	"	"	"	"	2		1H.3.5.11.28.39a	
930	"	"	09	30,0	"	"		1H.3.5.11.28.39a	

Bo2d

TYPE 1

Stålvogner

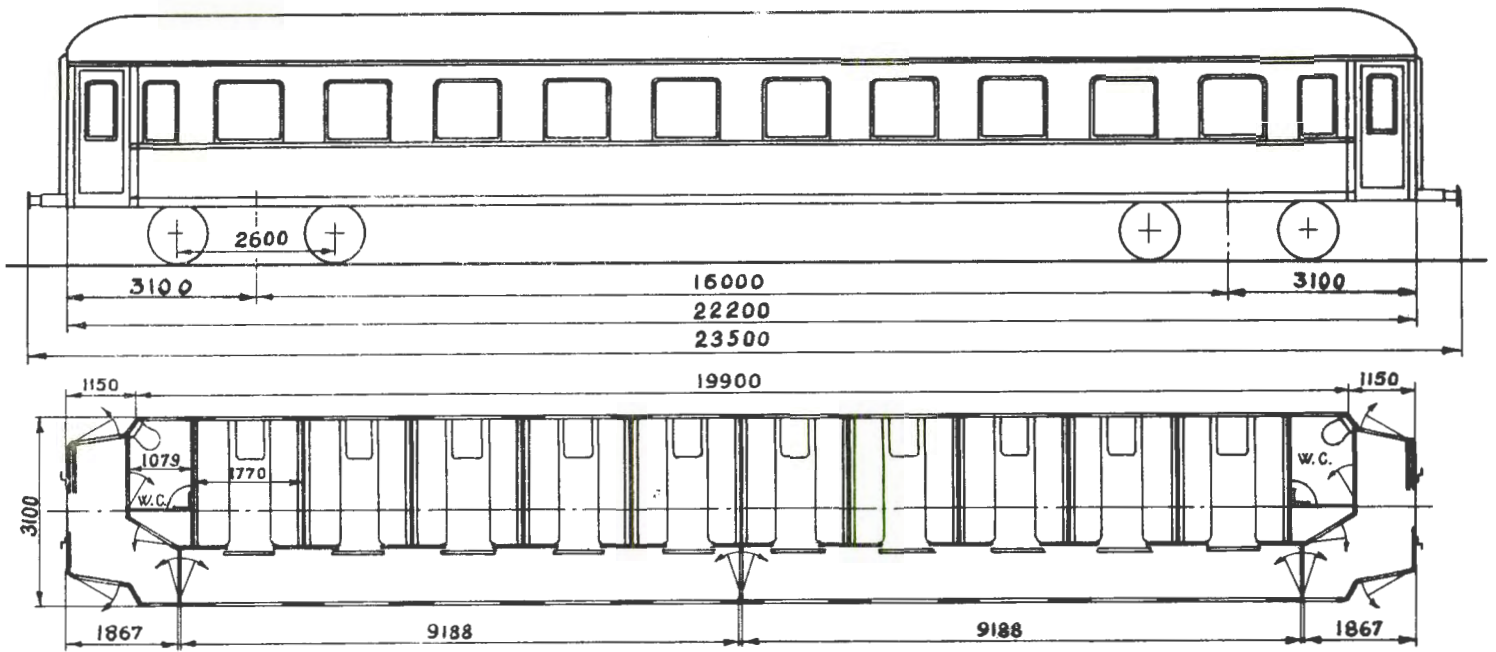

Hovedt. 5550

Vogn nr.	Distriktsmerke	Fabrikant	Byggeår	Omr. vognvekt i tonn	Sittepl. 2.klasse	Grunnriss	El. varme i kW	Vognutstyr (se side 6)	Merknad
19001	0	SJv	47	37,5	80	31	1H.3.5.11.28.39a		
19002	"	"	"	"	"	"	1Hs.3.5.11.28.39a		
19003	"	"	"	"	"	"	1Hs.3.5.11.28.39a		
19004	"	"	"	"	"	"	1H.3.5.11.28.39a		
19005	"	"	"	"	"	"	1H.3.5.11.28.39a		
19006	"	"	"	37,0	"	"	1H.3.5.11.28.39a		
19007	D	"	"	38,0	"	"	1H.3.5.11.28.39a		
19008	"	"	"	37,5	"	"	1H.3.5.11.28.39a		
19009	"	"	"	38,5	"	"	1H.3.5.11.28.39a		
19010	"	"	"	37,5	"	"	1H.3.5.11.28.39a		
19011	"	"	"	"	"	"	1H.3.5.11.28.39a		
19012	"	"	"	"	"	"	1H.3.5.11.28.39a		
19013	"	"	"	38,0	"	"	1H.3.5.11.28.39a		
19014	"	"	"	37,5	"	"	1H.3.5.11.28.39a		
19015	"	"	"	"	"	"	1H.3.5.11.28.39a		
19016	"	"	"	"	"	"	1H.3.5.11.28.39a		
19017	"	"	"	"	"	"	1H.3.5.11.28.39a		
19018	"	"	"	38,0	"	"	1H.3.5.11.28.39a	} Barnekupé	
19019	"	"	"	37,5	"	"	1H.3.5.11.28.39a		

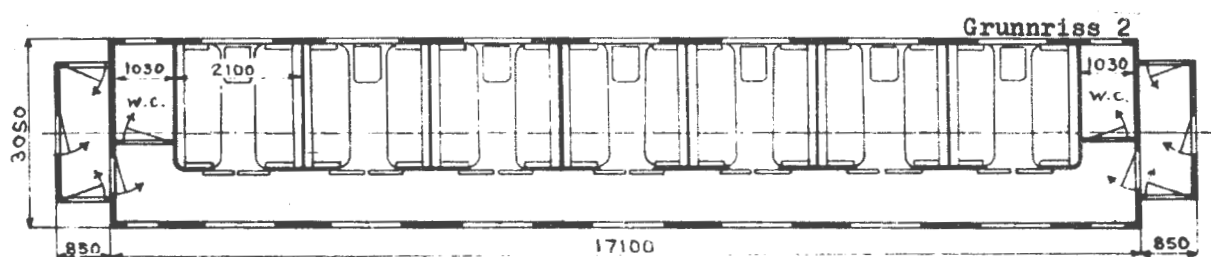
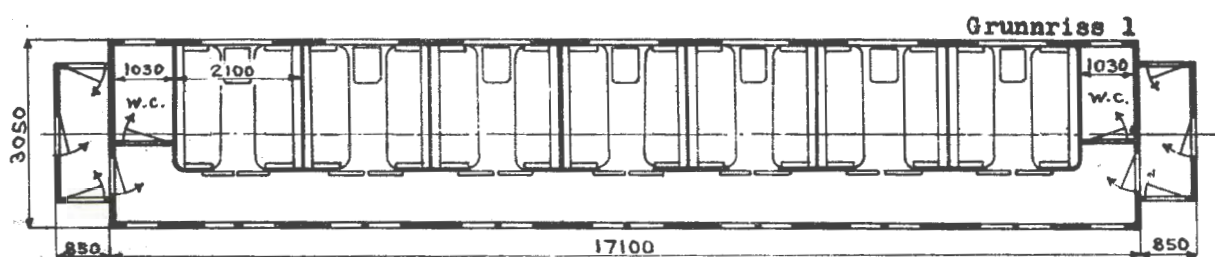
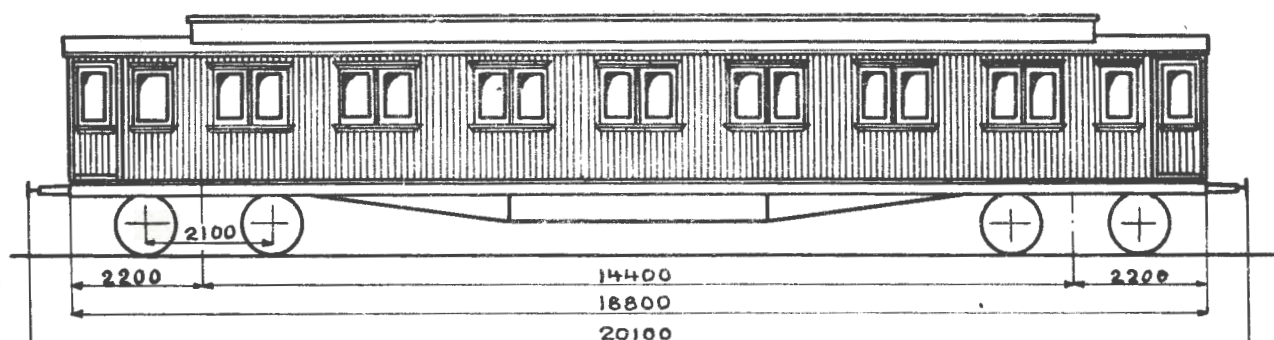

Oppr. hovedt. 700

Vogn nr.	Distriktsmerke	Fabrikant	Byggeår	Omtr. vognvekt i tonn	Sittepl. 2.klasse	Grunnriss	El. varme i kW	Vognutstyr (se side 6)	Merknad
928	B	Skb	05	29,5	56	1		1H.3.5.11.28.39a	
929	"	"	"	"	"	2		1H.3.5.11.28.39a	
930	"	"	09	30,0	"	"		1H.3.5.11.28.39a	
953	"	"	04	30,5	"	1		1H.3.5.11.28.39a	

Bo2d

TYPE 1

Stålvogner

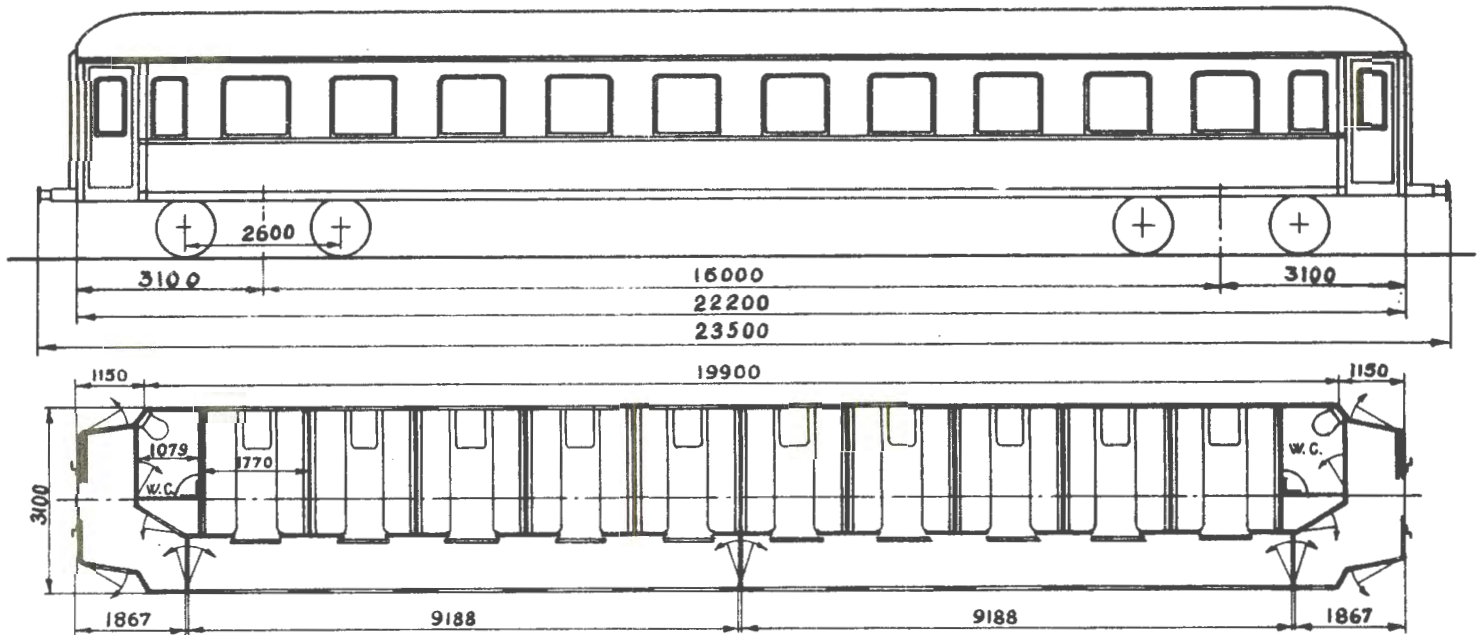

Hovedt. 5550

Vogn nr.	Distriktsmerke	Fabrikant	Byggeår	Omr. vognvekt i tonn	Sittepl. 2.klasse	Grunnriss	El. varme i kW	Vognutstyr (se side 6)	Merknad
19001	0	SJv	47	37,5	80		31	1Hs.3.5.11.28.39a	
19002	"	"	"	"	"		"	1Hs.3.5.11.28.39a	
19003	"	"	"	"	"		"	1Hs.3.5.11.28.39a	
19004	"	"	"	37,0	"		"	1H.3.5.11.28.39a	
19005	"	"	"	37,5	"		"	1H.3.5.11.28.39a	
19006	"	"	"	37,0	"		"	1H.3.5.11.28.39a	
19007	D	"	"	38,0	"		"	1H.3.5.11.28.39a	
19008	"	"	"	37,5	"		"	1H.3.5.11.28.39a	
19009	"	"	"	38,5	"		"	1H.3.5.11.28.39a	
19010	"	"	"	37,5	"		"	1H.3.5.11.28.39a	
19011	"	"	"	"	"		"	1H.3.5.11.28.39a	
19012	"	"	"	"	"		"	1H.3.5.11.28.39a	
19013	"	"	"	38,0	"		"	1H.3.5.11.28.39a	
19014	"	"	"	37,5	"		"	1H.3.5.11.28.39a	
19015	"	"	"	"	"		"	1H.3.5.11.28.39a	
19016	"	"	"	38,5	"		"	1H.3.5.11.28.39a	
19017	"	"	"	38,0	"		"	1H.3.5.11.28.39a	} Barnekupé
19018	"	"	"	"	"		"	1H.3.5.11.28.39a	
19019	"	"	"	37,5	"		"	1H.3.5.11.28.39a	

Vogn nr.	Distriktsmerke	Fabrikant	Byggeår	Omr. vognvekt i tonn	Sittepl. 2.klasse	Grunnriss	El. varme i kW.	Vognutstyr (se side 6)	Merknad
19020	D	SJv	47	38,5	80		31	1H.3.5.11.28.39a	} Barnekupe
19021	"	"	"	38,0	"		"	1H.3.5.11.28.39a	
19022	O	"	"	37,5	"		"	1H.3.5.11.28.39a	
19023	"	"	"	38,0	"		"	1H.3.5.11.28.39a	
19024	"	"	"	"	"		"	1H.3.5.11.28.39a	
19025	"	"	"	"	"		"	1H.3.5.11.28.39a	
19026	"	"	"	38,5	"		"	1H.3.5.11.28.39a	
19027	"	"	"	38,0	"		"	1H.3.5.11.28.39a	
19028	"	"	"	37,5	"		"	1H.3.5.11.28.39a	
19029	"	"	"	37,0	"		"	1H.3.5.11.28.39a	
19030	"	"	"	37,5	"		"	1H.3.5.11.28.39a	

Bo3a

TYPE 1

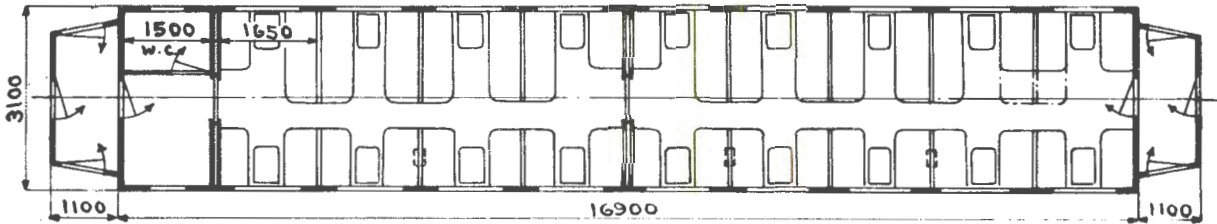
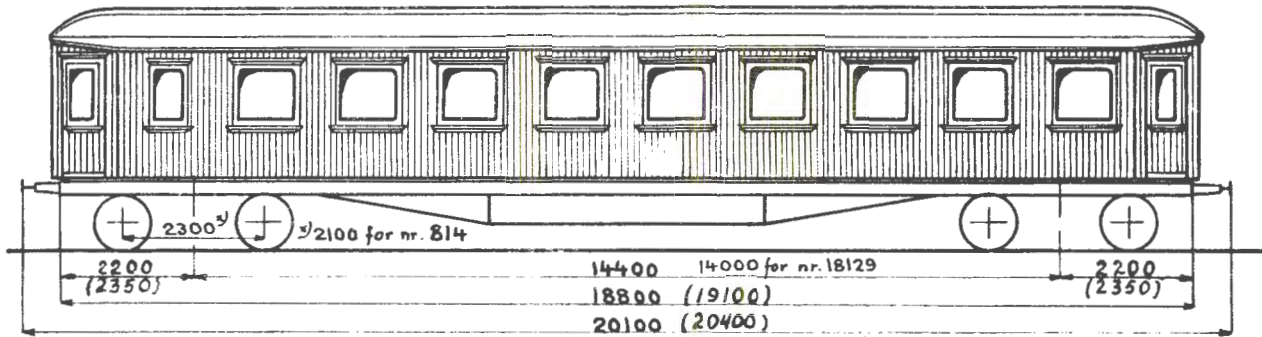

Mål i () gjelder vogner som har fått montert overgangsbelger (post 28 i utstyrsrubrikken).

1843
Hovedt. 2062
2966

Vogn nr.	Distriktsmerke	Fabrikant	Byggeår	Omtr. vognvekt i tonn	Sittepl. 2.klasse	Grunnriss	El. varme i kW	Vognutstyr (se side 6)	Merknad
175	0	Skb	23	31,5	84			1H.3.5.11.39a	1)
176	"	Str	25	32,5	"			1H.3.5.11.39a	1)
177	"	"	"	32,0	"			1H.3.5.11.39a	1)
179	"	"	"	33,5	"			1KK.3.5.11.28.39a	1) 3) 4)
180	"	"	"	31,5	"			1KK.3.5.11.28.39a	1) 4)
186	"	"	"	"	"			1H.3.5.11.39a	1)
187	"	"	"	31,0	"			1H.3.5.11.39a	1)
217	"	"	30	30,5	"			1H.3.11.39a	2)
219	"	"	"	31,0	"			1H.3.5.11.39a	2)
603	K	Kok	20	31,5	"			1H.3.5.11.28.39a	1) 4)
631	D	Skb	23	"	"			1H.3.5.11.39a	1)
633	"	"	"	31,0	"			1H.3.5.11.39a	1)
634	"	"	"	28,5	"			1H.3.5.11.39a	1)
635	"	"	"	30,0	"			1H.3.5.11.28.39a	1) 4)
636	"	"	24	32,0	"			1H.3.5.11.39a	1)
643	"	Str	26	31,0	"			1H.3.5.11.39a	2)
644	"	"	"	32,0	"			1H.3.5.11.39a	2)

- 1) Hovedt. 1843
 - 2) " 2966. Hvelvet tak
 - 3) Plattformsidedører slår ut
 - 4) Dobbelte plattformendedører
- Trykk nr. 751 1.7.58

Vogn nr.	Distriktsmerke	Fabrikant	Byggeår	Omtr. vognvekt i tonn	Sittepl. 2.klasse	Grunnriss	El. varme i kW	Vognutstyr (se side 6)	Merknad
19020	D	SJv	47	38,5	80		31	1H.3.5.11.28.39a	} Barnekupé
19021	"	"	"	38,0	"		"	1H.3.5.11.28.39a	
19022	0	"	"	37,5	"		"	1H.3.5.11.28.39a	
19023	"	"	"	38,0	"		"	1H.3.5.11.28.39a	
19024	"	"	"	"	"		"	1H.3.5.11.28.39a	
19025	"	"	"	"	"		"	1H.3.5.11.28.39a	
19026	"	"	"	38,5	"		"	1H.3.5.11.28.39a	
19027	"	"	"	38,0	"		"	1H.3.5.11.28.39a	
19028	"	"	"	37,5	"		"	1H.3.5.11.28.39a	
19029	"	"	"	37,0	"		"	1H.3.5.11.28.39a	
19030	"	"	"	37,5	"		"	1H.3.5.11.28.39a	

Bo3a

TYPE 1

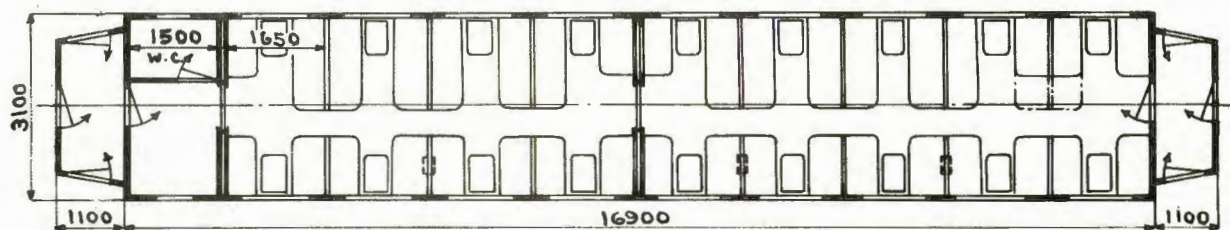
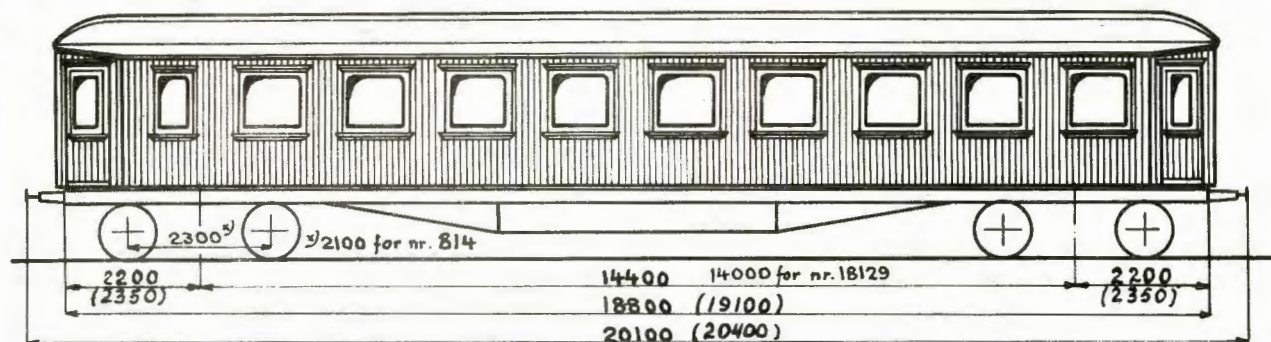

Mål i () gjelder vogner som har fått montert overgangsbelger (post 28 i utstyrsrubrikken).

Hovedt. 1843
2062
2966

Vogn nr.	Distriktsmerke	Fabrikant	Byggeår	Omtr. vognvekt i tonn	Sittepl. 2.klasse	Grunnriss	El.varme i kW	Vognutstyr (se side 6)	Merknad
175	0	Skb	23	30,5	84			1H.3.5.11.39a	1)
176	"	Str	25	32,5	"			1H.3.5.11.39a	1)
177	"	"	"	32,0	"			1H.3.5.11.39a	1)
179	"	"	"	33,5	"			1KK.3.5.11.28.39a	1) Plattformsidedører slår ut
180	"	"	"	31,5	"			1KK.3.5.11.28.39a	1) Dobbelte plattformendedører på nr. 179 og 80.
186	"	"	"	"	"			1H.3.5.11.39a	1)
187	"	"	"	31,0	"			1H.3.5.11.39a	1)
217	"	"	30	30,5	"			1H.3.11.39a	2)
219	"	"	"	31,0	"			1H.3.5.11.39a	2)
603	K	Kok	20	31,5	"			1H.3.5.11.39a	1)
631	D	Skb	23	31,5	"			1H.3.5.11.39a	1)
633	"	"	"	31,0	"			1H.3.5.11.39a	1)
634	"	"	"	28,5	"			1H.3.5.11.39a	1)
635	"	"	"	30,0	"			1H.3.5.11.28.39a	1) Dobbelte plattformendedører
636	"	"	24	32,0	"			1H.3.5.11.39a	1)
643	"	Str	26	31,0	"			1H.3.5.11.39a	2)
644	"	"	"	32,0	"			1H.3.5.11.39a	2)
646	K	Skb	28	31,0	"			1H.3.5.11.39a	2)
651	"	"	29	"	"			1H.3.5.7.11.39a	2)

1) Hovedt. 1843

2) " 2966. Hvelvet tak.

Trykk nr. 751 1.7.57

Vogn nr.	Distriktsmerke	Fabrikant	Byggeår	Omtr. vognvekt i tonn	Sittepl. 2.klasse	Grunnriss	El. varme i kW	Vognutstyr (se side 6)	Merknad
652	K	Skb	29	31,0	84			1H.3.5.11.39a	2)
788	H	"	24	32,0	"			1H.3.5.11.39a	1)
789	"	"	"	"	"			1H.3.5.7.11	1)
814	T	"	12	27,0	86			1H.3.5.7.11	3)
18030	"	Str	16	31,0	84			1H.3.5.7.11.28	1)
18031	"	"	"	32,5	"			1H.3.5.7.11.28	1) Dobbelte plattformendedører
18040	"	"	"	32,0	"			1H.3.5.7.11	1)
18041	"	"	"	32,5	"			1H.3.5.7.11.39a	1)
18053	"	"	17	31,5	"			1H.3.5.11	1)
18054	"	"	"	32,0	"			1H.3.5.7.11	1)
18077	"	Kok	20	"	"			1H.3.5.11.28.39a	1)
18078	"	"	"	31,0	"			1H.3.5.11.39a	1)
18110	"	Skb	24	31,5	"			1H.3.5.7.11	1)
18129	"	"	31	32,0	"			1H.3.5.11.39a	2)

- 1) Hovedt. 1843
2) " 2966. Hvelvet tak.
3) " 2062

Bo3a

TYPE 2

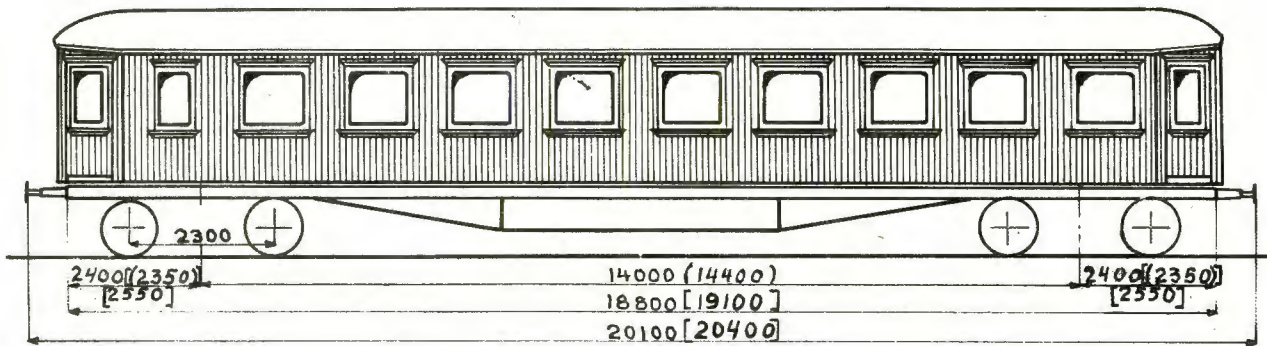

Mål i () gjelder vogner etter tegn. 1843

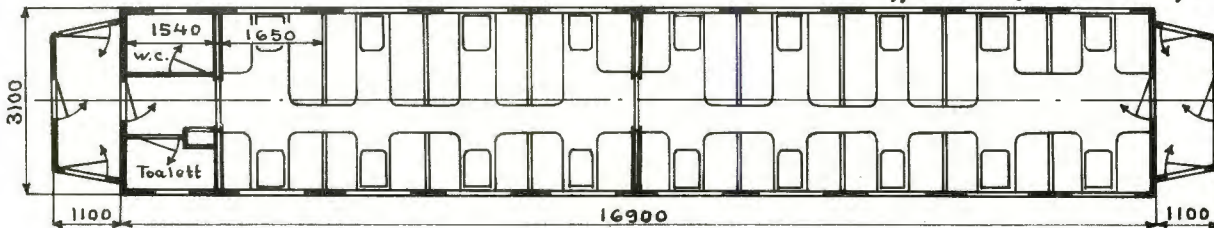

Mål i [] gjelder vogner som har fått montert overgangsbjelger (post 28 i utstyrsrubrikken).

Hovedt. 1843
4000

Vogn nr.	Distriktsmerke	Fabrikant	Byggeår	Omr. vognvekt i tonn	Sittep. 2.klasse	Grunnriss	El. varme i kW	Vognutstyr (se side 6).	Merknad
220	O	Str	36	31,5	84			1H.3.5.11.39a	
221	"	"	"	31,0	"			1H.3.5.11.39a	
222	"	"	"	30,5	"			1H.3.5.11.39a	
223	"	"	"	"	"			1H.3.5.11.39a	
658	D	"	"	31,0	"			1H.3.5.11.28.39a	
659	"	"	"	"	"			1H.3.5.11.39a	
663	"	"	37	30,5	"			1H.3.5.11.28.39a	
664	"	"	"	31,0	"			1H.3.5.11.39a	
886	O	"	16	31,5	"			1H.3.5.11.28.39a	1)
887	"	"	"	31,0	"			1H.3.5.11.28.39a	1)
18136	T	"	37	"	"			1H.3.5.11.28	
18137	"	"	"	30,5	"			1H.3.5.11.28	
18138	"	"	"	"	"			1H.3.5.11.28	

1) Hovedt. 1843

Trykk nr. 751 1.7.57

Vogn nr.	Distriktsmerke	Fabrikant	Byggear	Omr. vognvekt i tonn	Sittepl. 2.klasse	Grunnriss	El.varme i kW	Vognutstyr (se side 6)	Merknad
646	K	Skb	28	31,0	84			1H.3.5.11.39a	2)
651	"	"	29	32,5	"			1H.3.5.11.39a	2)
652	"	"	"	31,0	"			1H.3.5.11.39a	2)
788	H	"	24	32,0	"			1H.3.5.11.39a	1)
789	"	"	"	"	"			1H.3.5.7.11	1)
814	T	"	12	27,0	86			1H.3.5.7.11	3)
18030	"	Str	16	31,0	84			1H.3.5.7.11.28	1)
18031	"	"	"	32,5	"			1H.3.5.7.11.28	1) 4)
18040	"	"	"	32,0	"			1H.3.5.7.11	1)
18041	"	"	"	32,5	"			1H.3.5.7.11.39a	1)
18053	"	"	17	31,5	"			1H.3.5.11	1)
18054	"	"	"	32,0	"			1H.3.5.7.11	1)
18077	"	Kok	20	32,5	"			1H.3.5.11.28.39a	1)
18078	"	"	"	31,0	"			1H.3.5.11.39a	1)
18110	"	Skb	24	31,5	"			1H.3.5.7.11	1)
18129	"	"	31	32,0	"			1H.3.5.11.39a	2)

1) Hovedt. 1843

2) " 2966. Hvelvet tak

3) " 2062

4) Dobbelte plattformendedører

Trykk nr. 751 1.7.58

Bo3a

TYPE 2

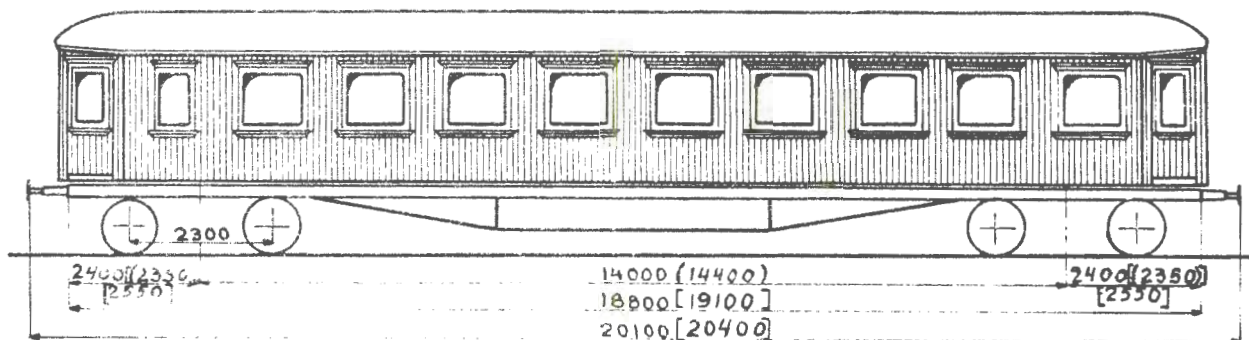

Mål i () gjelder vogner etter tegn. 1843

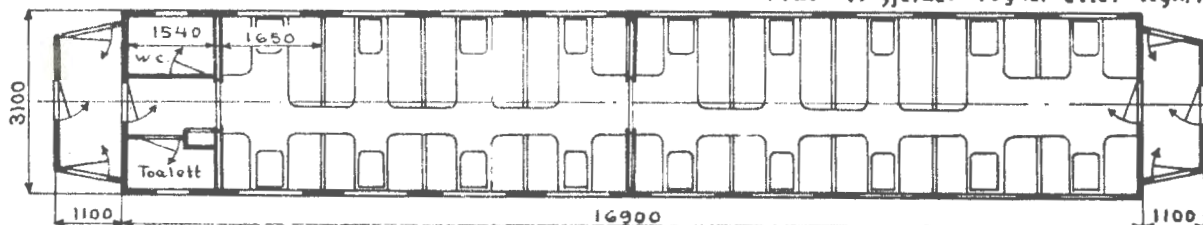

Mål i [] gjelder vogner som har fått montert overgangsbelger (post 28 i utstyrsrubrikken).

Hovedt. 1843
4000

Vogn nr.	Distriktsmerke	Fabrikant	Byggeår	Omtr. vognvekt i tonn	Sittepl. 2.klasse	Grunnriss	El. varme i kW	Vognutstyr (se side 6)	Merknad
220	0	Str	36	31,5	84			1H.3.5.11.39a	
221	"	"	"	31,0	"			1H.3.5.11.28.39a	1)
222	"	"	"	30,5	"			1H.3.5.11.28.39a	
223	"	"	"	"	"			1H.3.5.11.39a	
658	D	"	"	31,0	"			1H.3.5.11.28.39a	
659	"	"	"	"	"			1H.3.5.11.39a	
663	"	"	37	30,5	"			1H.3.5.11.28.39a	
664	"	"	"	31,0	"			1H.3.5.11.39a	
886	0	"	16	31,5	"			1H.3.5.11.28.39a	2)
887	"	"	"	31,0	"			1H.3.5.11.28.39a	2)
18136	T	"	37	32,0	"			1H.3.5.11.28.39a	
18137	"	"	"	30,5	"			1H.3.5.11.28.39a	
18138	"	"	"	"	"			1H.3.5.11.28	

1) Dobbelte plattformendedører

2) Hovedt. 1843

Trykk nr. 751 1.7.58

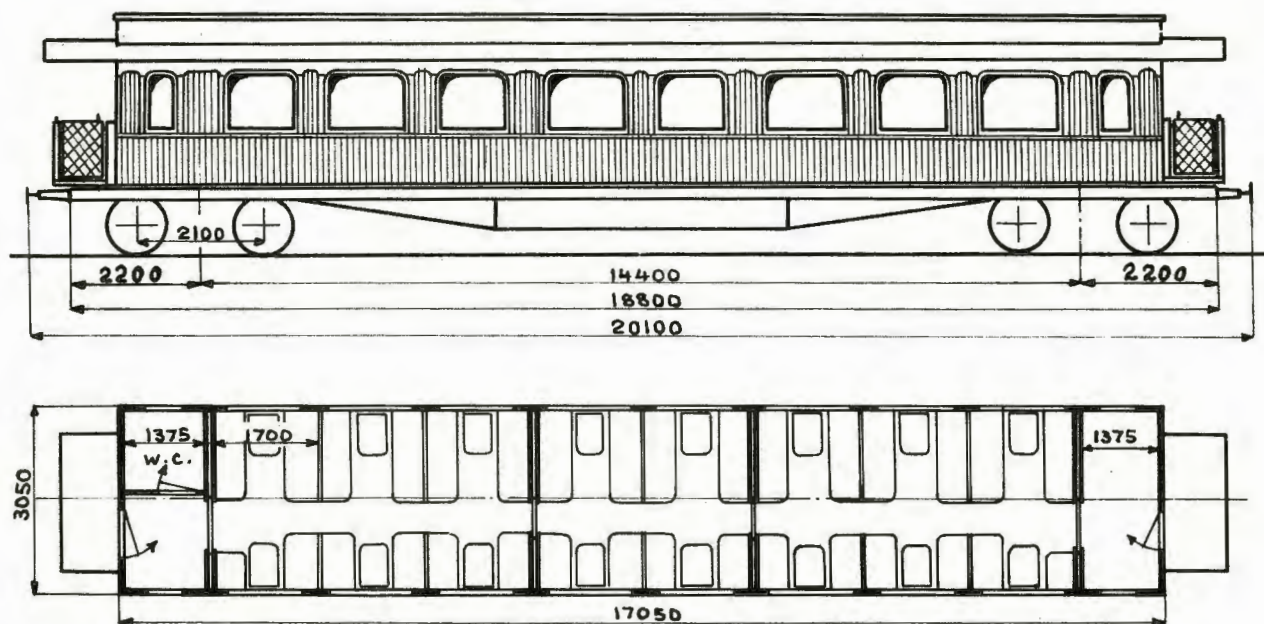

Hovedt. B. 225

Vogn n.:	Distriktsmerke	Fabrikant	Byggeår	Omtr. vognvekt i tonn	Sittepl. 2.klasse	Grunnriss	El. varme i kW	Vognutstyr (se side 6)	Merknad
80	0	Str	10	29,0	78			1H.3.5.11.39a	3 stk. klappseter i forgang
81	"	"	"	30,0	"			1H.3.5.11.39a	} 4 " " " "
82	"	"	"	"	"			1H.3.5.11.39a	
83	"	"	"	29,5	"			1H.3.5.11.39a	

Bo3b

TYPE 2

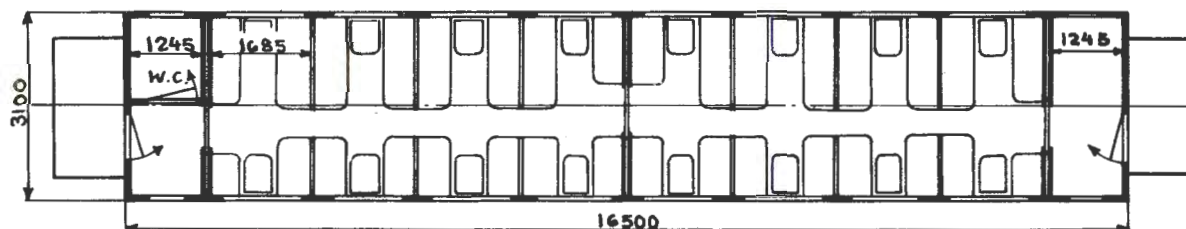
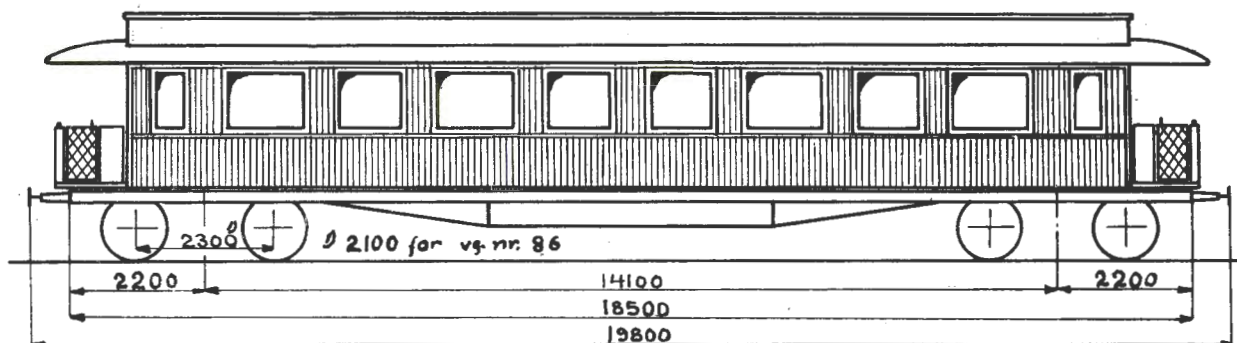

Hovedt. B. 387

Vogn nr.	Distriktsmerke	Fabrikant	Byggeår	Omr. vognvekt i tonn	Sittepl. 2.klasse	Grunnriss	El.varme i kW	Vognutstyr (se side 6)	Merknad
84	0	Str	16	32,5	76			1H.3.5.11.39a	
85	"	"	"	33,0	"			1H.3.5.11.39a	3 stk. klappseter i forgang
86	"	"	"	31,0	"			1H.3.5.11.39a	

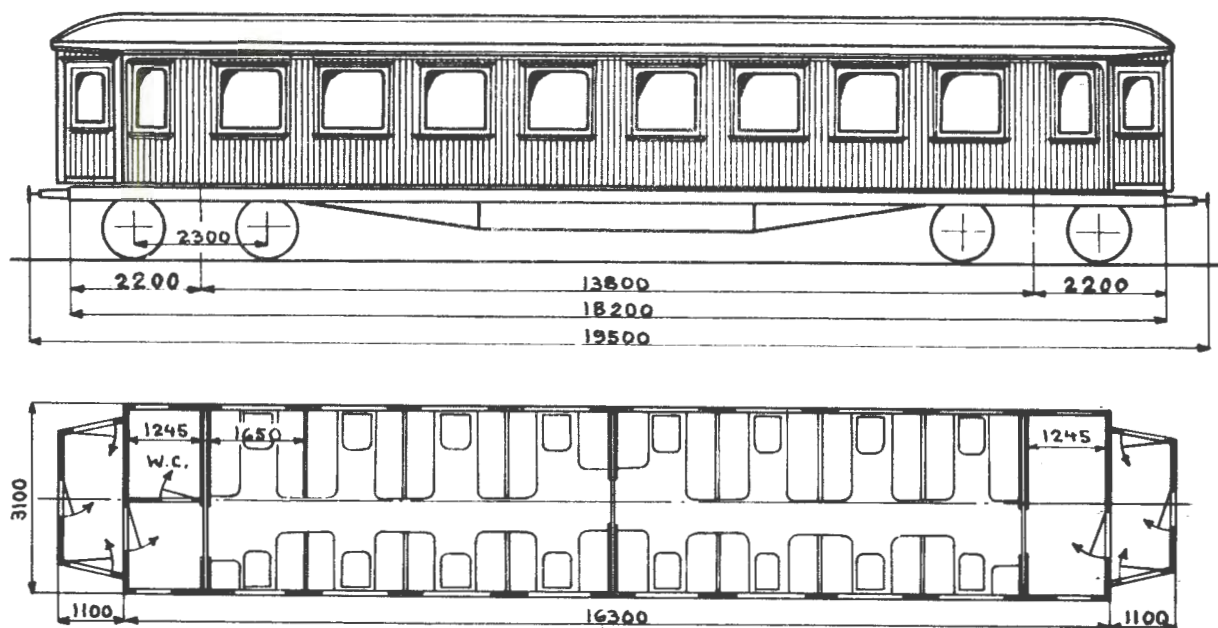

Hovedt. 2755

Vogn nr.	Distriktsmerke	Fabrikant	Byggeår	Omtr. vognvekt i tonn	Sittepl. 2.klasse	Grunnriss	El. varme i kW	Vognutstyr (se side 6)	Merknad
87	0	Skb	24	31,5	76			1H.3.5.11.39a	
88	"	"	"	"	"			1H.3.5.11.39a	
89	"	"	"	"	"			1H.3.5.11.39a	1)

1) 3 stk. klappseter i forgang
Trykk nr. 751 1.7.58

Bo3b

TYPE 4

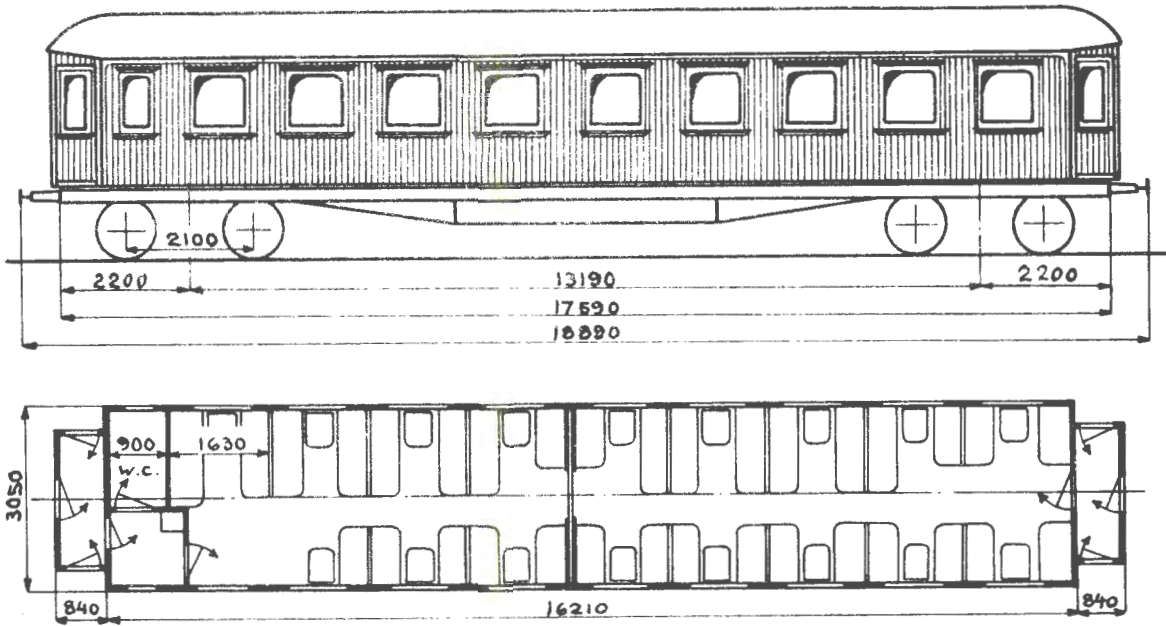

Oppr. hovedt. 651

Vogn nr.	Distriktsmerke	Fabrikant	Byggeår	Omtr. vognvekt i tonn	Sittepl. 2.klasse	Grunnriss	El. varme i kW	Vognutstyr (se side 6)	Merknad
683	N	Str	02	27,0	79			1H.3.5.11	
684	"	"	"	26,0	"			1H.3.6.10.39a	

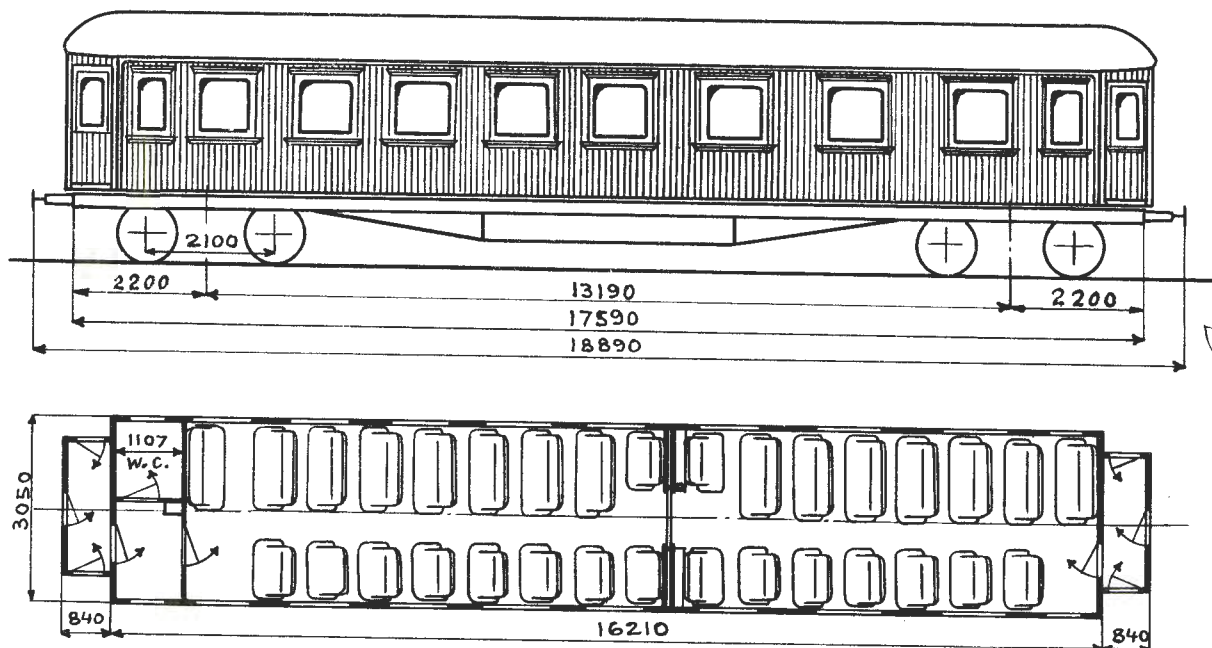
Oppr. hovedt. 469¹⁾

Vogn nr.	Distriktsmerke	Fabrikant	Byggeår	Omtr. vognvekt i tonn	Sittepl. 2.klasse	Grunnriss	El. varme i kW	Vognutstyr (se side 6)	Merknad
681	N	Str	02	26,0	79			1H.3.6.10.39a.41	
682	"	"	"	26,6	"			1H.3.6.10.39a.41	

1) Forandr. etter Nrv. d. skisse dat. 10.6.38

Bo3c

TYPE 1

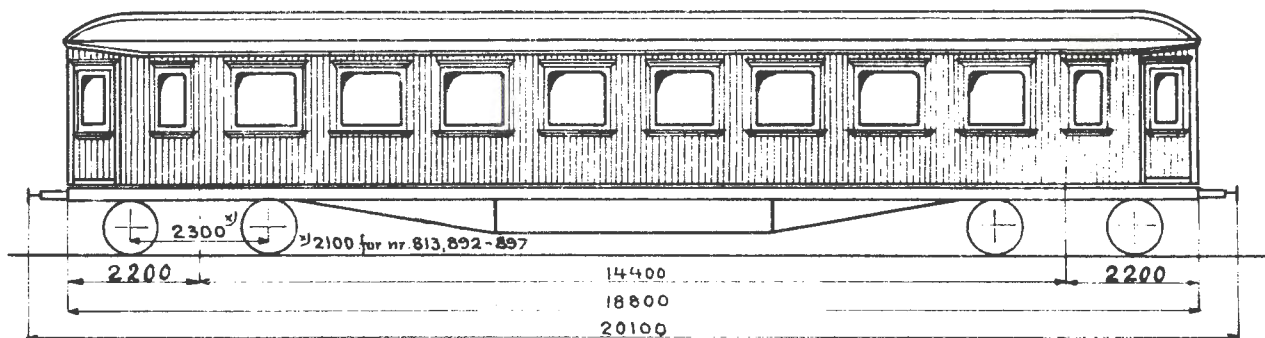

Grunnriss 1

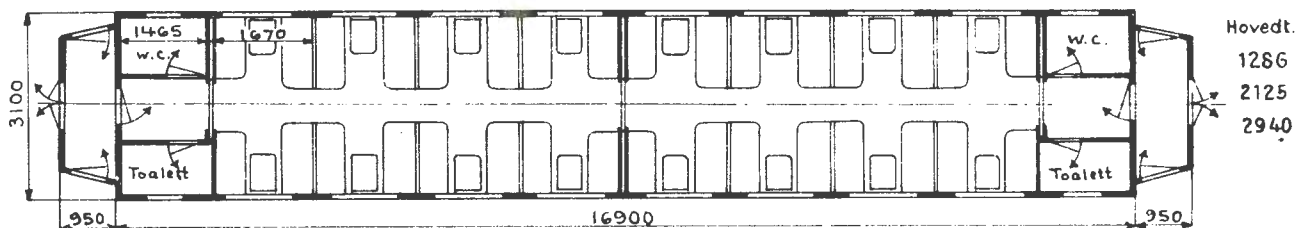

Hovedt.

1286

2125

2940

Grunnriss 2

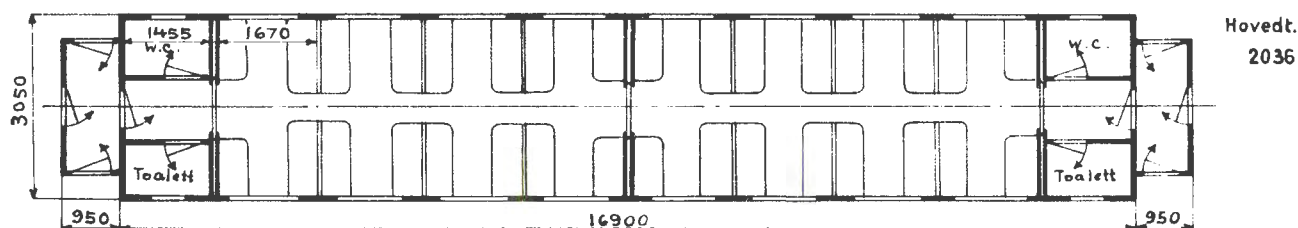

Hovedt.

2036

Vogn nr.	Distriktsmerke	Fabrikant	Byggeår	Omr. vognvekt i tonn	Sittepl. 2.klasse	Grunnriss	El.varme i kW	Vognutstyr (se side 6)	Merknad
160	D	Str	13	32,0	64	1		1H.3.5.11.28.39a	1) 3)
286	0	"	19	33,0	"	"		1KK.3.5.11.28.39a	2)
287	"	"	"	32,5	"	"		1KK.3.5.11.28.39a	2)
288	"	"	"	32,0	"	"		1KK.3.5.11.28.39a	2)
289	"	"	"	33,5	"	"		1KK.3.5.11.28.39a	2)
553	D	"	14	32,5	"	"		1H.3.5.11.28.39a	1)
554	"	"	"	33,0	"	"		1H.3.5.11.28.39a	1)
555	"	"	"	32,5	"	"		1H.3.5.11.39a	1)
556	"	"	"	"	"	"		1H.3.5.11.28.39a	1)
557	"	"	"	33,5	"	"		1H.3.5.11.28.39a	1)
558	"	"	"	31,0	"	"		1H.3.5.11.28.39a	2)

1) Hovedt. 1286

2) " 2125

3) Enkle plattformendedører

Trykk nr. 751 1.7.58

Vogn nr.	Distriktsmerke	Fabrikant	Byggeår	Omtr. vognvekt i tonn	Sittepl. 2.klasse	Grunnriss	El. varme i kW	Vognutstyr (se side 6)	Merknad
555	D	Str	14	32,5	64	1		1H.3.5.11.39a	Hovedt. 1286
556	"	"	"	"	"	"		1H.3.5.11.28.39a	
557	"	"	"	33,5	"	"		1H.3.5.11.28.39a	Hovedt. 2125
558	"	"	"	31,0	"	"		1H.3.5.11.28.39a	
559	"	"	"	33,0	"	"		1H.3.5.11.28.39a	Hovedt. 1286
18007	O	"	"	"	"	"		1H.3.5.11.39a	
18008	"	"	"	32,5	"	"		1H.3.5.11.28.39a	Hovedt. 2125
560	D	"	15	32,0	"	"		1H.3.5.11.28.39a	
561	"	"	"	33,5	"	"		1H.3.5.11.28.39a	Hovedt. 2125
562	"	"	"	32,5	"	"		1H.3.5.11.39a	
286	O	"	19	33,0	"	"		1KK.3.5.11.28.39a	Hovedt. 2125
287	"	"	"	32,5	"	"		1KK.3.5.11.28.39a	
288	"	"	"	32,0	"	"		1KK.3.5.11.28.39a	Hovedt. 2125
289	"	"	"	34,0	"	"		1KK.3.5.11.28.39a	
773	B	Scd	20	30,5	"	"		1H.3.5.11.28.39a	Hovedt. 2125
774	H	"	"	32,5	"	"		1H.3.5.11.28.39a	
18059	D	"	"	33,0	"	"		1H.3.5.11.28.39a	Hovedt. 2940. Hvelvet tak.
18060	"	"	"	32,5	"	"		1H.3.5.11.39a	
18061	"	"	"	"	"	"		1H.3.5.11.28.39a	Hovedt. 2940. Hvelvet tak.
791	H	Str	23	"	"	"		1H.3.5.11.28.39a	
742	"	Skb	24	31,5	"	"		1H.3.5.11.28.39a	Hovedt. 2940. Hvelvet tak.
743	"	"	"	33,0	"	"		1H.3.5.11.28.39a	
790	"	Str	"	34,5	"	"		1H.3.5.7.11.28.39a	Hovedt. 2940. Hvelvet tak.
746	"	Skb	27	32,5	"	"		1H.3.5.11.28.39a	
748	"	"	28	32,0	"	"		1H.3.5.11.28.39a	Hovedt. 2940. Hvelvet tak.
749	"	"	"	32,5	"	"		1H.3.5.11.28.39a	

Bo3c

TYPE 2

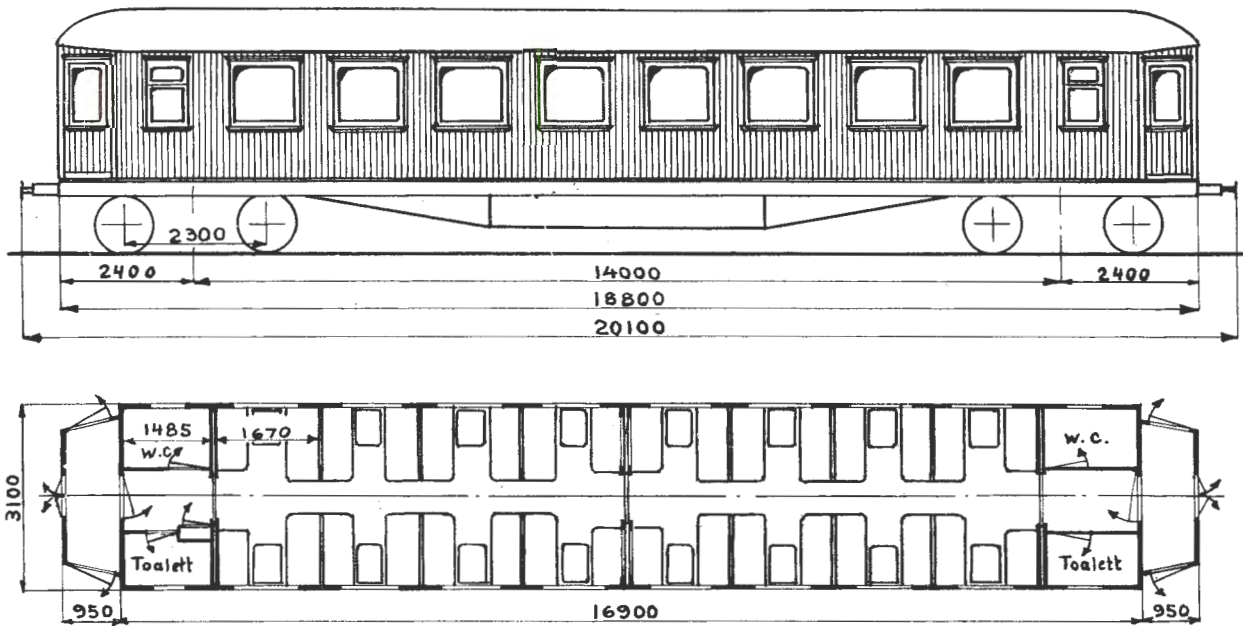

Hovedt. 4194

Vogn nr.	Distriktsmerke	Fabrikant	Byggeår	Omr. vognvekt i tonn	Sittepl. 2.klasse	Grunnriss	El. varme i kW	Vognutstyr (se side 6)	Merknad
305	O	Skb	08	30,0	64			1H.3.5.11.28.39a	} Nye vognkasser
18036	T	Str	16	33,0	"			1H.3.5.11.28.39a	
18049	"	Skb	17	"	"			1H.3.5.11.28.39a	
294	O	Str	21	32,0	"			1H.3.5.11.28.39a	
707	H	"	26	31,5	"			1H.3.5.11.28.39a	
645	K	Skb	28	31,0	"			1H.3.5.11.28.39a	
747	O	"	"	31,5	"			1H.3.5.11.28.39a	
665	D	"	37	"	"			1H.3.5.11.28.39a	
666	"	"	"	32,0	"			1H.3.5.11.28.39a	
18146	B	"	"	"	"			1H.3.5.11.28.39a	
18147	"	"	"	32,5	"			1H.3.5.11.28.39a	
18148	"	"	"	32,0	"			1H.3.5.11.28.39a	
18149	"	"	"	"	"			1H.3.5.11.28.39a	

Vogn nr.	Distriktsmerke	Fabrikant	Byggeår	Omr. vognvekt i tonn	Sittepl. 2.klasse	Grunnriss	El. varme i kW	Vognutstyr (se side 6)	Merknad
559	D	Str	14	33,0	64	1		1H.3.5.11.28.39a	2)
560	"	"	15	32,0	"	"		1H.3.5.11.28.39a	2)
561	"	"	"	33,5	"	"		1H.3.5.11.28.39a	2)
562	"	"	"	32,5	"	"		1H.3.5.11.39a	2)
742	H	Skb	24	31,5	"	"		1H.3.5.11.28.39a	2)
743	"	"	"	33,0	"	"		1H.3.5.11.28.39a	2)
746	"	"	27	32,5	"	"		1H.3.5.11.28.39a	3)
748	"	"	28	32,0	"	"		1H.3.5.11.28.39a	3)
749	"	"	"	32,5	"	"		1H.3.5.11.28.39a	3)
773	B	Scd	20	30,5	"	"		1H.3.5.11.28.39a	2)
774	H	"	"	32,5	"	"		1H.3.5.11.28.39a	2)
790	"	Str	24	34,5	"	"		1H.3.5.7.11.28.39a	2)
791	"	"	23	32,5	"	"		1H.3.5.11.28.39a	2)
813	T	"	11	29,0	"	2		1H.3.5.11.28	4)
889	B	"	13	32,0	"	1		1H.3.5.11.28.39a	1) Enkle plattformendedører
892	O	"	12	30,0	"	"		1H.3.5.11.28.39a	1)
893	"	"	"	30,5	"	"		1H.3.5.11.28.39a	1)
894	"	"	"	30,0	"	"		1H.3.5.11.28.39a	1)
895	"	"	"	30,5	"	"		1H.3.5.11.28.39a	1)
896	"	"	"	29,5	"	"		1H.3.5.11.28.39a	1)
897	"	"	"	"	"	"		1H.3.5.11.28.39a	1)
18007	"	"	14	33,0	"	"		1H.3.5.11.39a	1)
18008	"	"	"	32,5	"	"		1H.3.5.11.28.39a	1)
18059	D	Scd	20	33,0	"	"		1H.3.5.11.28.39a	2)
18060	"	"	"	32,5	"	"		1H.3.5.11.39a	2)
18061	"	"	"	"	"	"		1H.3.5.11.28.39a	2)

- 1) Hovedt. 1286
2) " 2125
3) " 2940. Hvelvet tak.
4) " 2036

Bo3c

TYPE 2

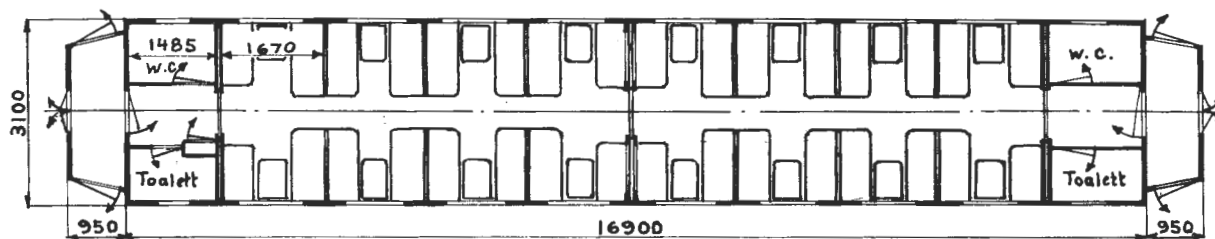
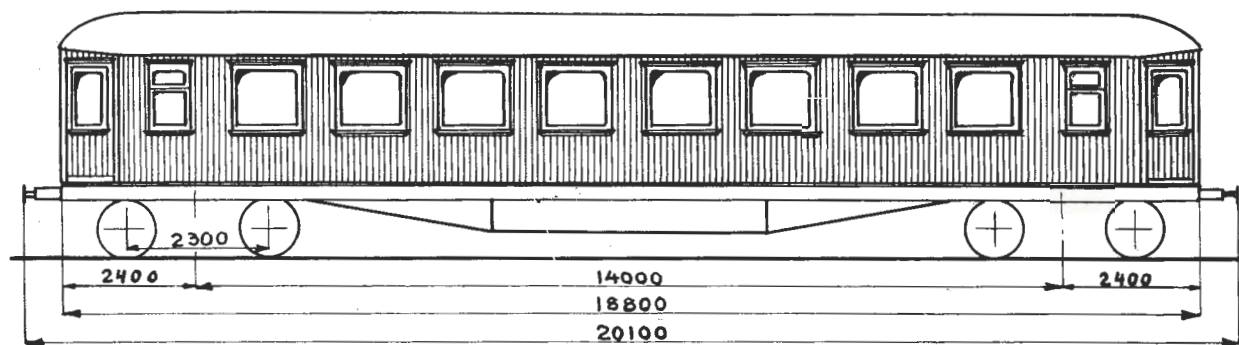

Hovedt. 4194

Vogn nr.	Distriktsmerke	Fabrikant	Byggeår	Omr. vognvekt i tonn	Sittepl. 2.klasse	Grunnriss	El.varme i kW	Vognutstyr (se side 6)	Merknad
305	0	Skb	08	30,0	64			1H.3.5.11.28.39a	} Nye vognkasser
18036	T	Str	16	33,0	"			1H.3.5.11.28.39a	
18049	"	Skb	17	"	"			1H.3.5.11.28.39a	
294	0	Str	21	32,0	"			1H.3.5.11.28.39a	
707	H	"	26	31,5	"			1H.3.5.11.28.39a	
645	K	Skb	28	31,0	"			1H.3.5.11.28.39a	
747	0	"	"	31,5	"			1H.3.5.11.28.39a	
665	D	"	37	"	"			1H.3.5.11.28.39a	
666	"	"	"	32,0	"			1H.3.5.11.28.39a	
18146	B	"	"	"	"			1H.3.5.11.28.39a	
18147	"	"	"	32,5	"			1H.3.5.11.28.39a	
18148	"	"	"	32,0	"			1H.3.5.11.28.39a	
18149	"	"	"	"	"			1H.3.5.11.28.39a	

Vogn nr.	Distriktsmerke	Fabrikant	Byggeår	Omtr. vognvekt i tonn	Sittepl. 2.klasse	Grunnriss	El. varme i kW	Vognutstyr (se side 6)	Merknåd
559	D	Str	14	33,0	64	1		1H.3.5.11.28.39a	2)
560	"	"	15	32,0	"	"		1H.3.5.11.28.39a	2)
561	"	"	"	33,5	"	"		1H.3.5.11.28.39a	2)
562	"	"	"	32,5	"	"		1H.3.5.11.39a	2)
742	H	Skb	24	31,5	"	"		1H.3.5.11.28.39a	2)
743	"	"	"	33,0	"	"		1H.3.5.11.28.39a	2)
746	"	"	27	32,5	"	"		1H.3.5.11.28.39a	3)
748	"	"	28	32,0	"	"		1H.3.5.11.28.39a	3)
749	"	"	"	31,5	"	"		1H.3.5.11.28.39a	3)
773	B	Scd	20	30,5	"	"		1H.3.5.11.28.39a	2)
774	H	"	"	32,5	"	"		1H.3.5.11.28.39a	2)
790	"	Str	24	34,5	"	"		1H.3.5.7.11.28.39a	2)
791	"	"	23	32,5	"	"		1H.3.5.11.28.39a	2)
813	T	"	11	29,0	"	2		1H.3.5.11.28	4)
889	B	"	13	32,0	"	1		1H.3.5.11.28.39a	1) 5)
892	O	"	12	30,0	"	"		1H.3.5.11.28.39a	1)
893	"	"	"	30,5	"	"		1H.3.5.11.28.39a	1)
894	"	"	"	30,0	"	"		1H.3.5.11.28.39a	1)
895	"	"	"	30,5	"	"		1H.3.5.11.28.39a	1)
896	"	"	"	29,5	"	"		1H.3.5.11.28.39a	1)
897	"	"	"	"	"	"		1H.3.5.11.28.39a	1)
18007	"	"	14	33,0	"	"		1H.3.5.11.39a	1)
18008	"	"	"	32,5	"	"		1H.3.5.11.28.39a	1)
18059	D	Scd	20	33,0	"	"		1H.3.5.11.28.39a	2)
18060	"	"	"	32,5	"	"		1H.3.5.11.28.39a	2)
18061	"	"	"	"	"	"		1H.3.5.11.28.39a	2)

- 1) Hovedt. 1286
2) " 2125
3) " 2940. Hvelvet tak
4) " 2036
5) Enkle plattformendedører

Bo3c

TYPE 2

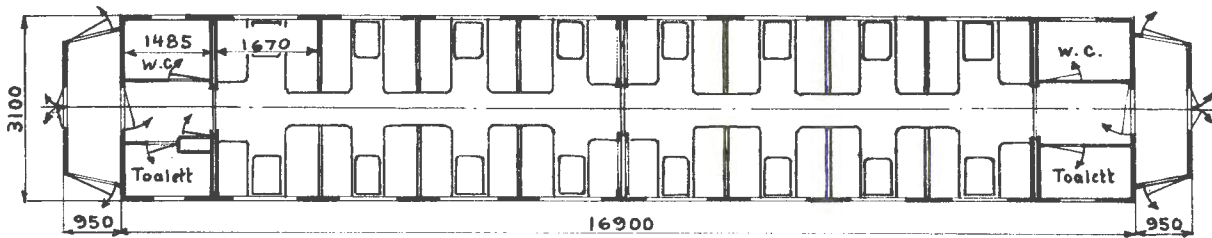
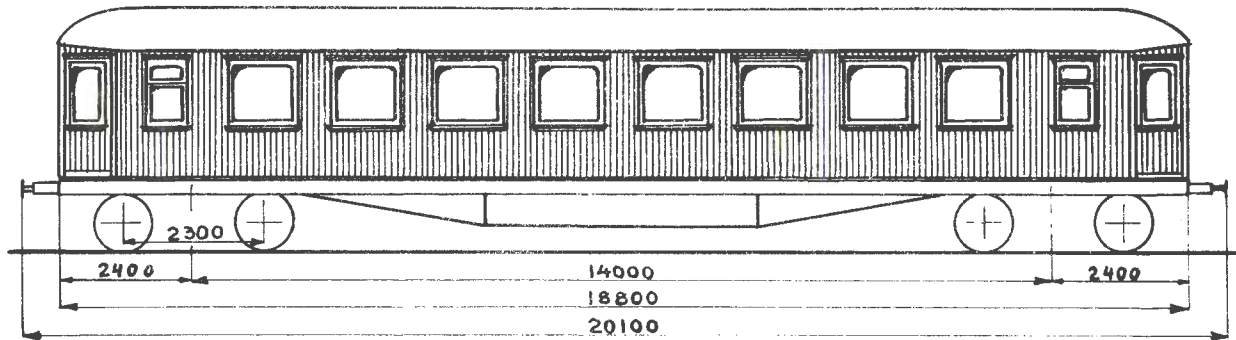

Hovedt. 4194

Vogn nr.	Distriktsmerke	Fabrikant	Byggeår	Omr. vognvekt i tonn	Sittepl. 2.klasse	Grunnriss	El. varme i kW	Vognutstyr (se side 6)	Merknad
294	0	Str	21	32,0	64			1H.3.5.11.28.39a	1)
305	"	Skb	08	30,0	"			1H.3.5.11.28.39a	1)
645	K	"	28	31,0	"			1H.3.5.11.28.39a	1)
665	D	"	37	33,0	"			1H.3.5.11.28.39a	2)
666	"	"	"	32,0	"			1H.3.5.11.28.39a	2)
707	H	Str	26	31,5	"			1H.3.5.11.28.39a	1)
747	0	Skb	28	31,5	"			1H.3.5.11.28.39a	1)
18036	T	Str	16	33,0	"			1H.3.5.11.28.39a	1)
18049	"	Skb	17	"	"			1H.3.5.11.28.39a	1)
18146	B	"	37	32,0	"			1H.3.5.11.28.39a	2)
18147	"	"	"	32,5	"			1H.3.5.11.28.39a	2)
18148	"	"	"	32,0	"			1H.3.5.11.28.39a	2)
18149	"	"	"	"	"			1H.3.5.11.28.39a	2)

1) Nye vognkasser

2) Plattformsidedører slår ut

Trykk nr. 751 1.7.58

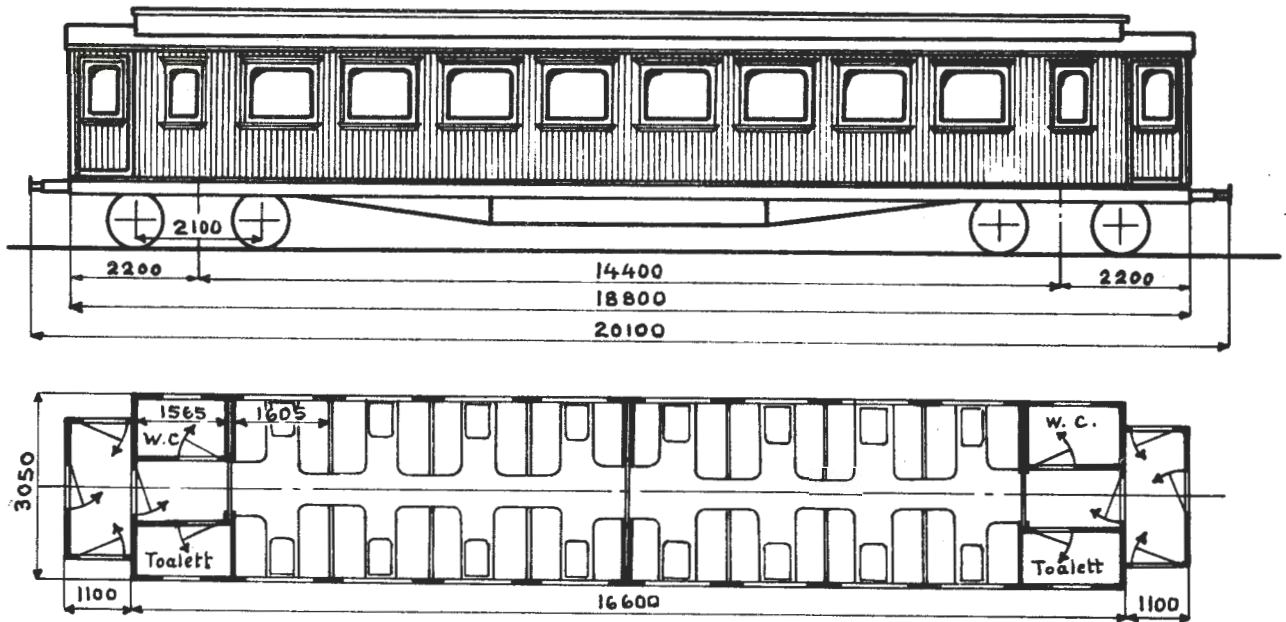

Hovedt. 999

Vogn nr.	Distriktsmerke	Fabrikant	Byggeår	Omtr. vognvekt i tonn	Sittepl. 2.klasse	Grunnriss	El.varme i kW	Vognutstyr (se side 6)	Merknad
920	B	Str	09	29,0	64			1H.3.5.11.28.39a	
973	"	"	"	29,5	"			1H.3.5.11.28.39a	
974	"	"	"	28,5	"			1H.3.5.11.28	
975	"	"	"	"	"			1H.3.11.28.39a	

Bo3d

TYPE 1
Trevogner med plateledning

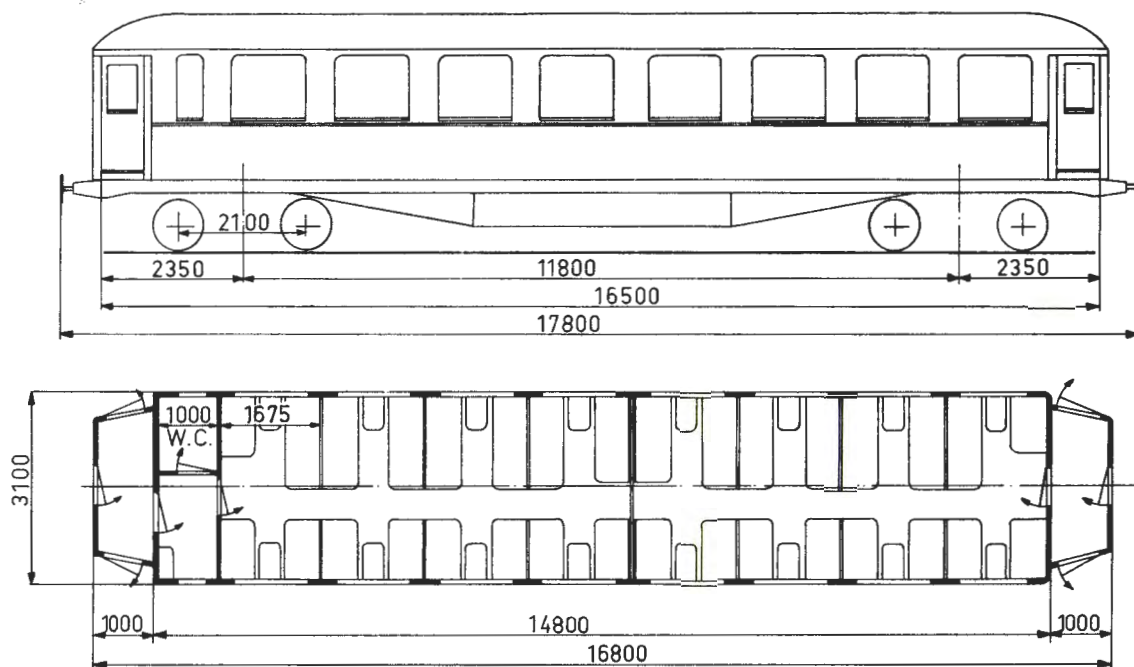

Hovedt. 3590

Vogn nr.	Distriktsmerke	Fabrikant	Byggear	Omr. vognvekt i tonn	SittepL. 2.klasse	Grunnriss	El.varme i kW	Vognutstyr (se side 6)	Merknad
450	B	Skb	34	21,5	78			1H.3.5.12.39a	} Tilhenger for motorvogn
451	.	"	"	21,0	"			1H.3.5.12.39a	
452	.	"	"	"	"			1H.3.5.12.39a	
453	.	"	"	22,0	"			1H.3.5.12.39a	

Bo3d

TYPE 2

Lettmetallvogner

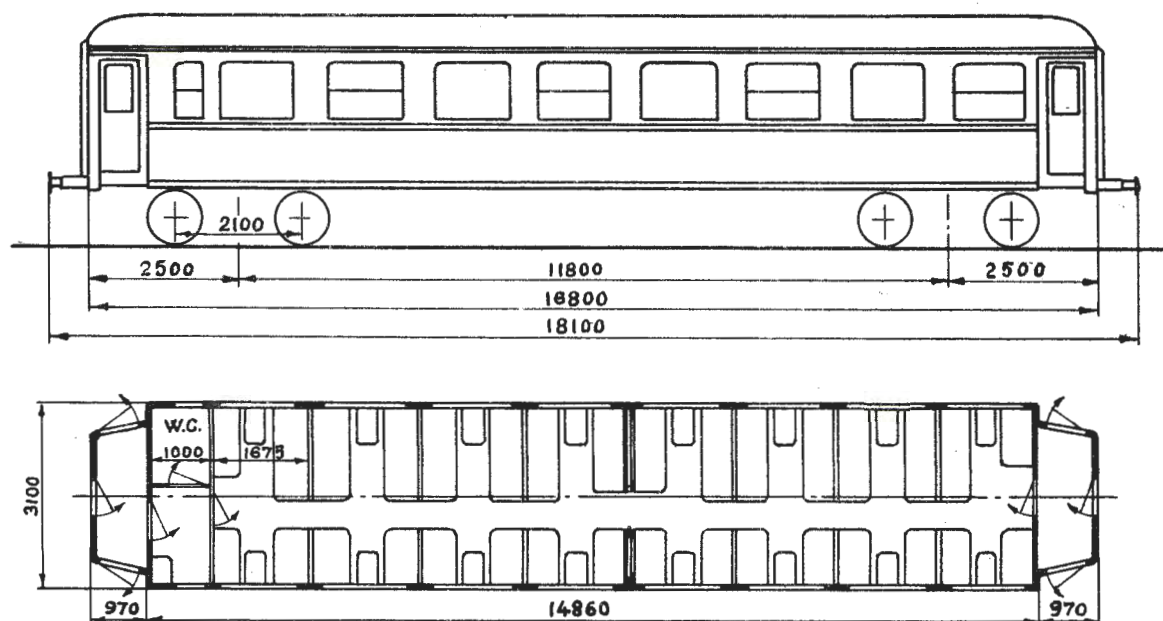

Hovedt. 5190

Vogn nr.	Distriktsmerke	Fabrikant	Byggeår	Omr. vognvekt i tonn	Sittepl. 2.klasse	Grunnriss	El. varme i kW	Vognutstyr (se side 6)	Merknad
18171	B	Str	47	20,0	78			1H.3.6.12.39a	
18172	"	"	"	"	"			1H.3.6.12.39a	
18173	"	"	"	"	"			1H.3.6.12.39a	

Bo3f

TYPE 1
Stålvogner

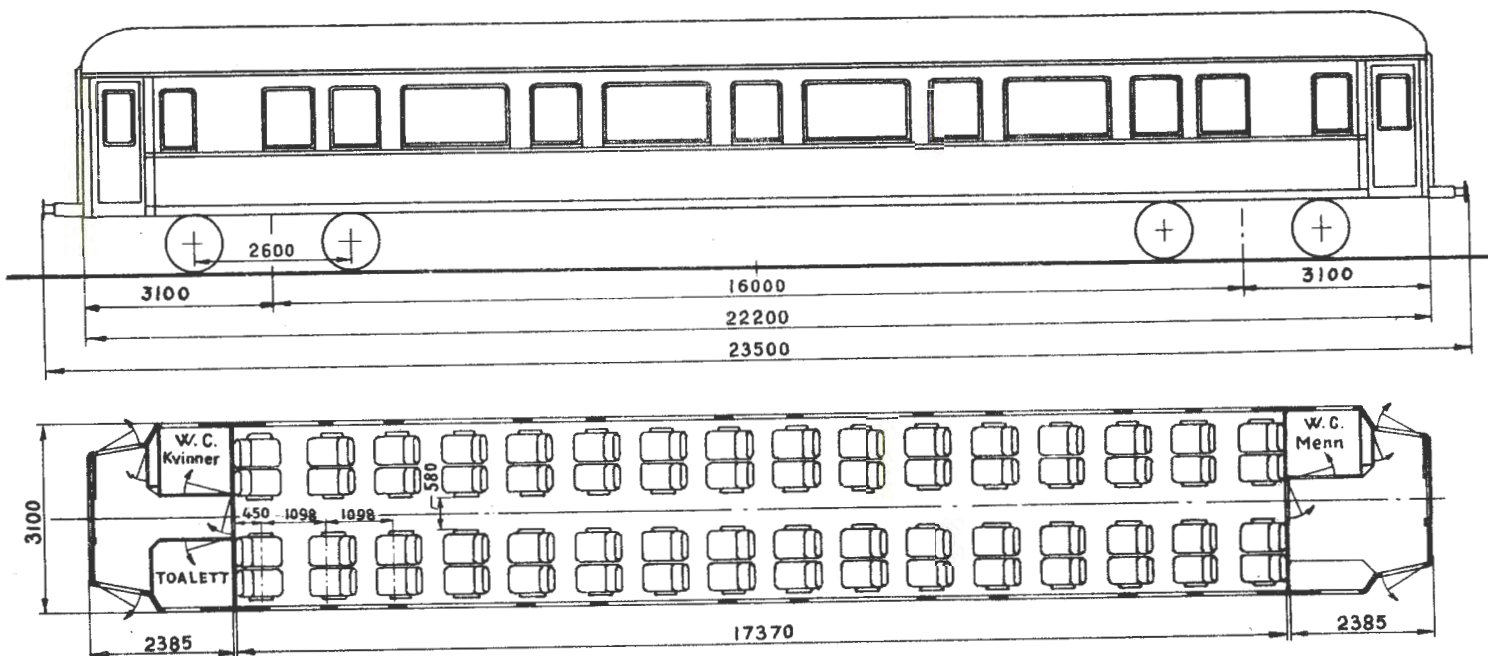

Hovedt. 5971

Vogn nr.	Distriktsmerke	Fabrikant	Byggeår	Omr. vognvekt i tonn	Sittepl. 2.klasse	Grunnriss	El.varme i kW	Vognutstyr (se side 6)	Merknad
19031	0	Skb	50	38,0	64		31	1H.3.5.11.28.39a	
19032	"	"	"	"	"		"	1H.3.5.11.28.39a	
19033	"	"	"	"	"		"	1H.3.5.11.28.39a	
19034	"	"	"	"	"		"	1H.3.5.11.28.39a	
19035	"	"	"	"	"		"	1H.3.5.11.28.39a	
19036	"	"	"	"	"		"	1H.3.5.11.28.39a	
19037	"	"	"	"	"		"	1H.3.5.11.28.39a	
19038	"	"	51	37,5	"		"	1H.3.5.11.28.39a	
19039	"	"	"	"	"		"	1H.3.5.11.28.39a	
19040	"	"	"	37,0	"		"	1H.3.5.11.28.39a	
19041	D	"	"	38,0	"		"	1H.3.5.11.28.39a	
19042	"	"	"	"	"		"	1H.3.5.11.28.39a	
19043	"	"	"	"	"		"	1H.3.5.11.28.39a	
19044	"	"	"	38,5	"		"	1H.3.5.11.28.39a	
19045	"	"	"	37,5	"		"	1H.3.5.11.28.39a	
19046	"	"	"	"	"		"	1H.3.5.11.28.39a	
19047	"	"	52	38,0	"		"	1H.3.5.11.28.39a	
19048	"	"	"	37,5	"		"	1H.3.5.11.28.39a	
19049	"	"	"	"	"		"	1H.3.5.11.28.39a	

Vogn nr.	Distriktsmerke	Fabrikant	Byggeår	Omtr: vognvekt i tonn	Sittepl. 2.klasse	Grunnriss	El.varme i kW	Vognutstyr (se side 6)	Merknad
19050	D	Skb	52	38,0	64		31	1H.3.5.11.28.39a	
19051	O	"	"	"	"		"	1Hs.3.5.11.28.39a	
19052	"	"	"	"	"		"	1H.3.5.11.28.39a	
19053	"	"	"	"	"		"	1Hs.3.5.11.28.39a	
19054	"	"	"	"	"		"	1H.3.5.11.28.39a	
19055	"	"	"	37,5	"		"	1H.3.5.11.28.39a	
19056	"	"	53	38,0	"		"	1H.3.5.11.28.39a	
19057	"	"	"	"	"		"	1H.3.5.11.28.39a	
19058	T	"	"	"	"		"	1H.3.5.11.28.39a	
19059	"	"	"	38,5	"		"	1H.3.5.11.28.39a	
19060	"	"	"	"	"		"	1H.3.5.11.28.39a	

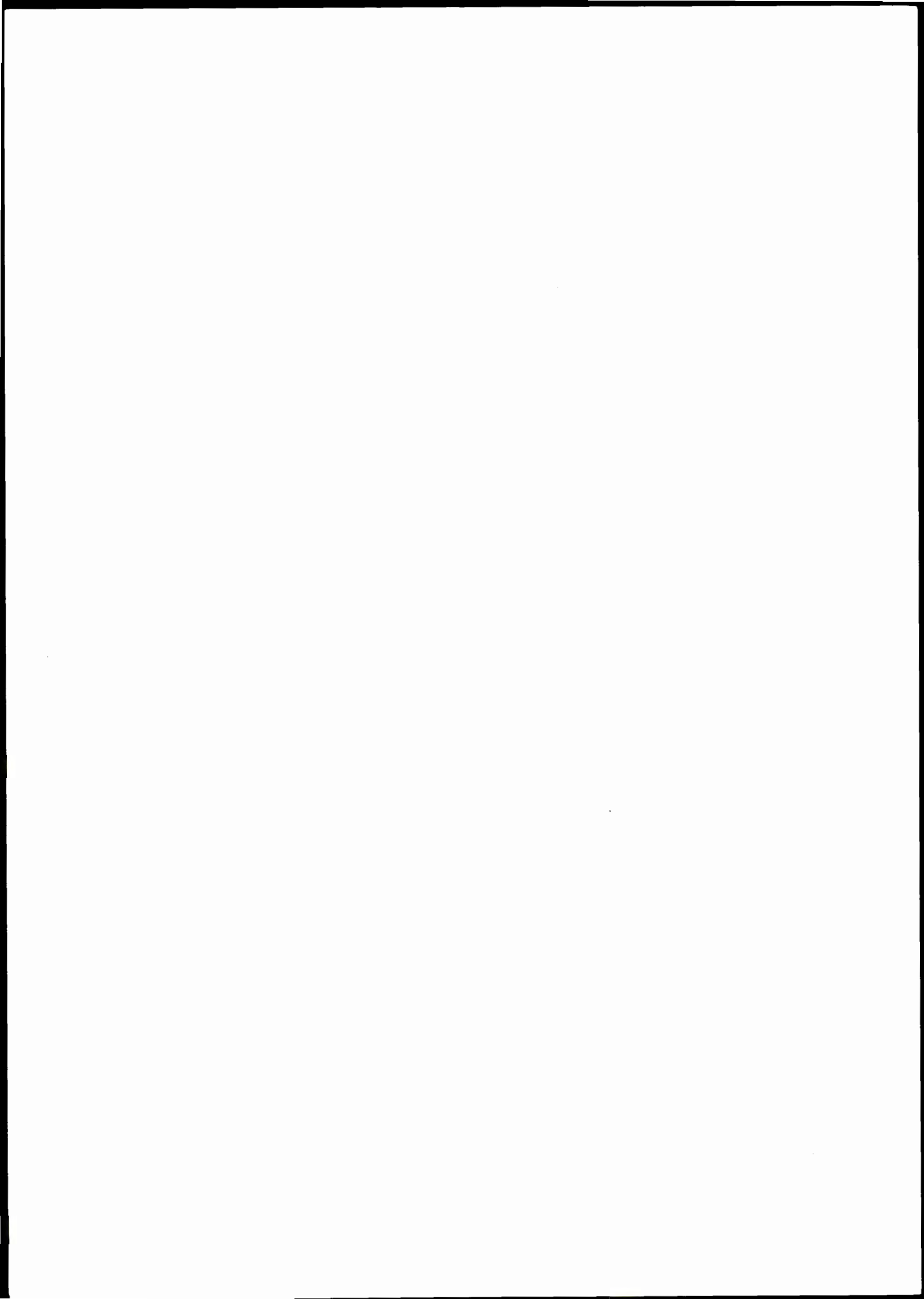

Vogn nr.	Distriktsmerke	Fabrikant	Byggeår	Omtr. vognvekt i tonn	Sittepl. 2.klasse	Grunnriss	El. varme i kW	Vognutstyr (se side 6)	Merknad
19050	D	Skb	52	38,0	64	31		1H.3.5.11.28.39a	
19051	0	"	"	"	"	"		1Hs.3.5.11.28.39a	
19052	"	"	"	"	"	"		1Hs.3.5.11.28.39a	
19053	"	"	"	"	"	"		1Hs.3.5.11.28.39a	
19054	"	"	"	"	"	"		1Hs.3.5.11.28.39a	
19055	"	"	"	37,5	"	"		1H.3.5.11.28.39a	
19056	"	"	53	38,0	"	"		1H.3.5.11.28.39a	
19057	"	"	"	"	"	"		1Hs.3.5.11.28.39a	
19058	T	"	"	"	"	"		1H.3.5.11.28.39a	
19059	"	"	"	38,5	"	"		1H.3.5.11.28.39a	
19060	"	"	"	"	"	"		1H.3.5.11.28.39a	

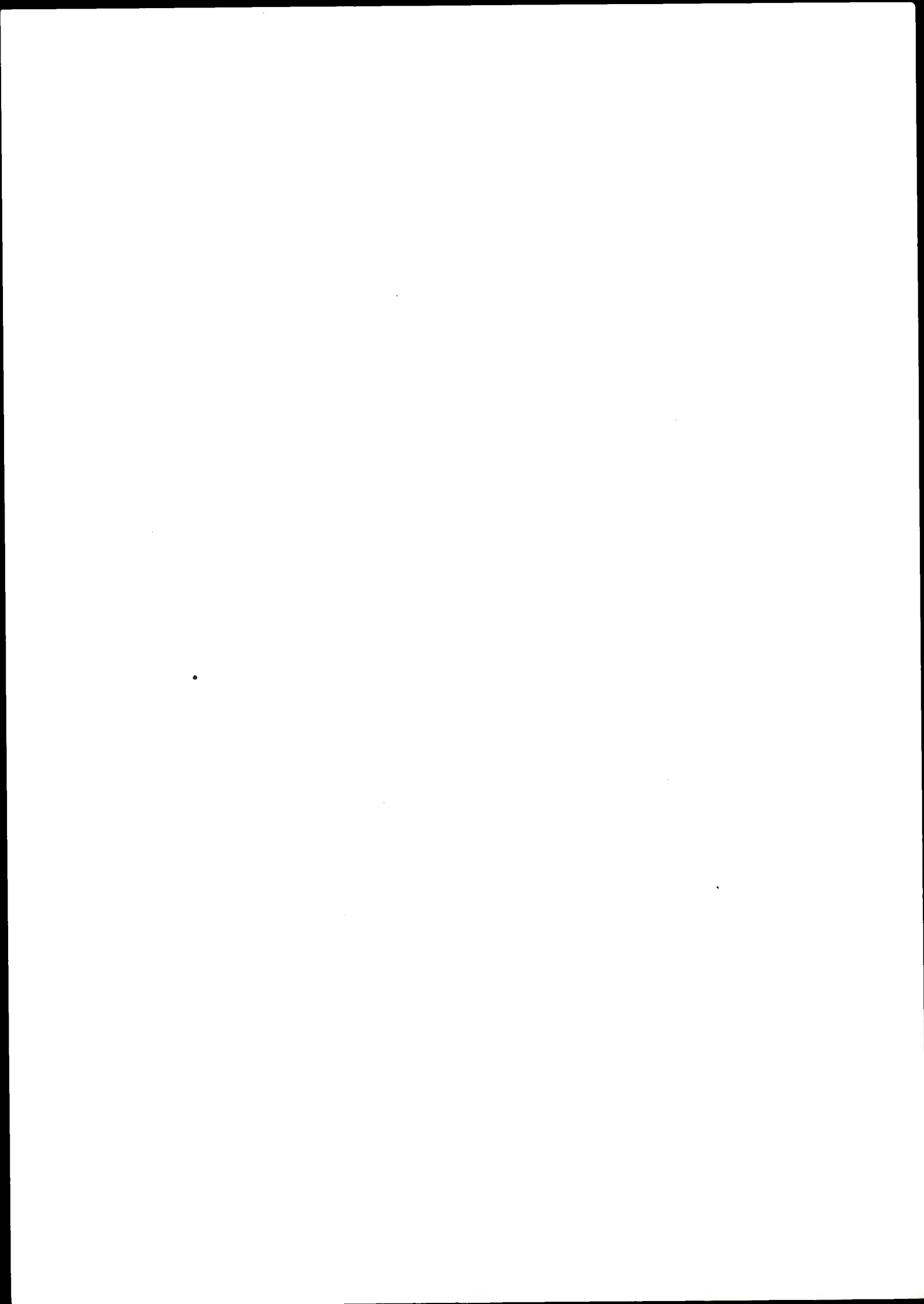

Bo3g

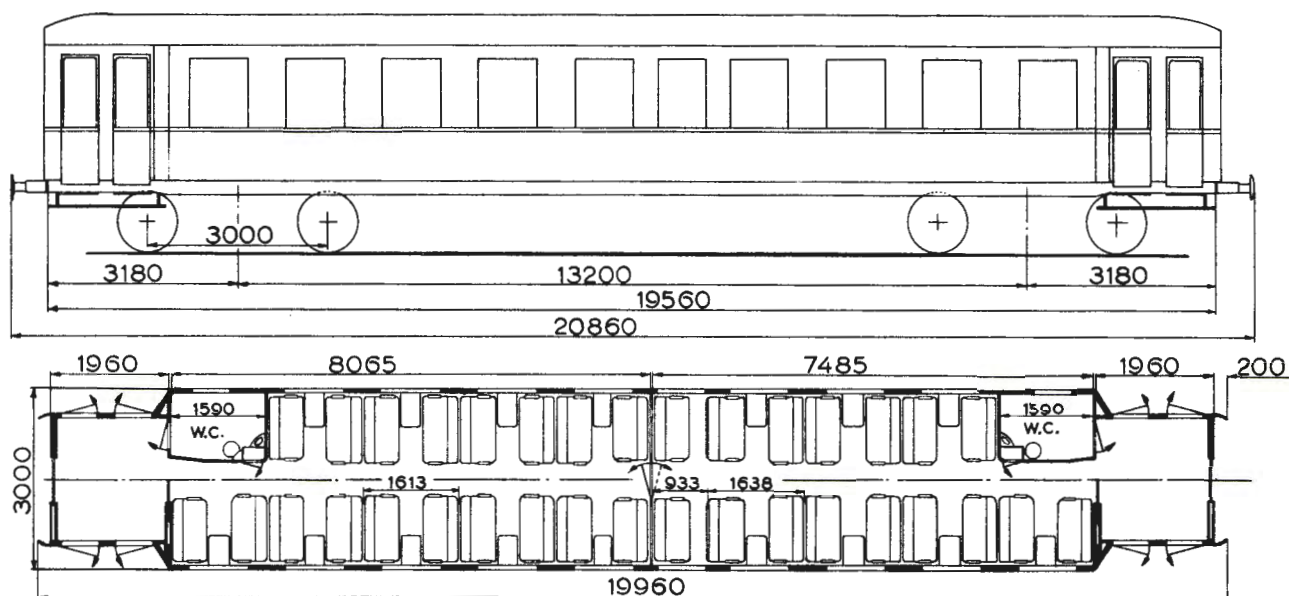
TYPE 1
Stålvogner

Hovedt. 7442

Vogn nr.	Distriktsmerke	Fabrikant	Byggeår	Omt. vognvekt i tonn	Sittepl. 2.klasse	Grunnriss	Elvarme i kW	Vognutstyr (se side 6)	Merknad
19922	O		39	32,5	68		27	1H. 3. 5. 11. 28. 39a	
19923	"		"	"	"		"	1H. 3. 5. 11. 28. 39a	
19924	"		"	"	"		"	1H. 3. 5. 11. 28. 39a	
19925	"		"	"	"		"	1H. 3. 5. 11. 28. 39a	
19926	"		"	33,0	"		"	1H. 3. 5. 11. 28. 39a	
19927	"		"	32,5	"		"	1H. 3. 5. 11. 28. 39a	
19928	"		"	"	"		"	1H. 3. 5. 11. 28. 39a	
19929	"		40	"	"		"	1H. 3. 5. 11. 28. 39a	

Bo3g

TYPE 2

Stålvogn

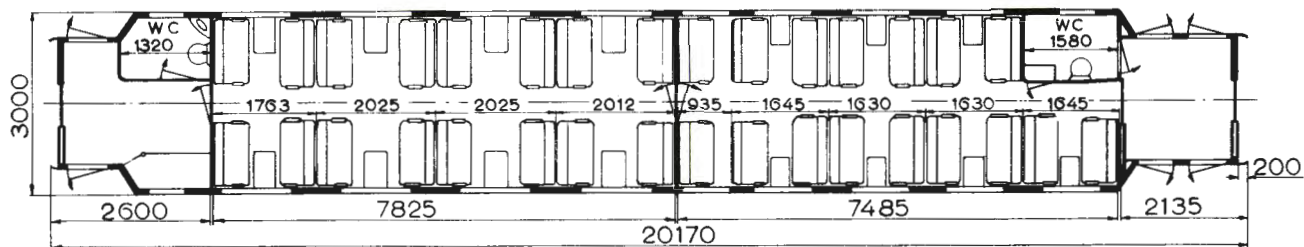
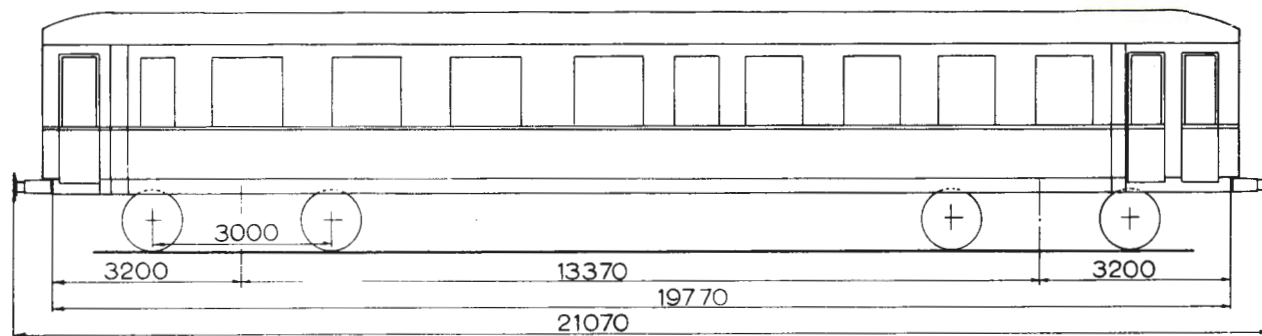

Hovedt. 8136

Vogn nr.	Distriktsmerke	Fabrikant	Byggeår	Omtr. vognvekt i tonn	Sittepl. 2. klasse	Grunnriss	El. varme i kW	Vognutstyr (se side 6)	Merknad
19930	O		39	33,0	64	27	1H. 3. 5. 11. 28. 39a		

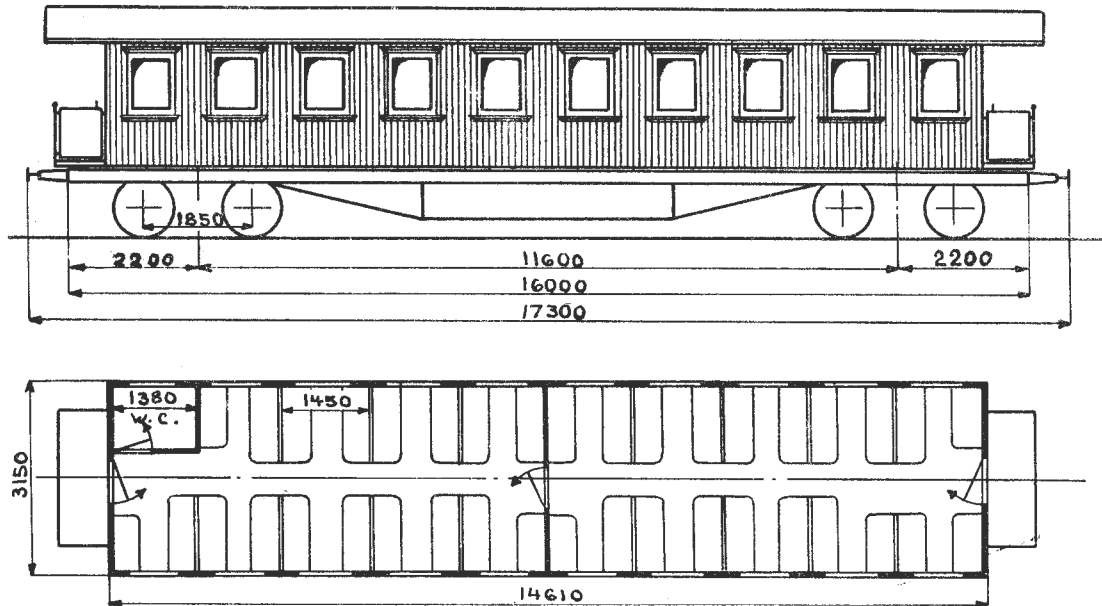

Hovedt. 2828

Vogn nr.	Distriktsmerke	Fabrikant	Byggeår	Omr. vognvekt i tonn	Sittepl. 2.klasse	Grunnriss	El. varme i kW	Vognutstyr (se side 6)	Merknad
127	0	Str	24	20,5	106			1H.3.5.13	
128	"	"	"	20,0	"			1H.3.5.13	
129	"	"	"	19,5	"			1H.3.5.8.13	
130	"	"	"	20,5	"			1H.3.5.8.13	
140	"	"	"	20,0	"			1H.3.5.13	El. lys for tilkobl. til nabovg.
141	"	"	25	19,5	"			1H.3.5.13	
142	"	"	"	21,0	"			1H.3.5.13	
143	"	"	"	21,5	"			1H.3.5.13	
144	"	"	"	20,5	"			1H.3.5.13	
146	"	"	"	"	"			1H.3.5.13	
147	"	"	"	20,0	"			1H.3.5.13	
148	"	"	"	20,5	"			1H.3.5.13	
149	"	"	"	20,0	"			1H.3.5.13	
150	"	"	"	"	"			1H.3.5.13	El. lys for tilkobl. til nabovg.
194	"	"	26	21,5	"			1H.3.5.13	
195	"	"	"	19,0	"			1H.3.5.13	
196	"	"	"	"	"			1H.3.5.13	
197	"	"	"	19,5	"			1H.3.5.13	
198	"	"	"	"	"			1H.3.5.13	

Bo4b

TYPE 1

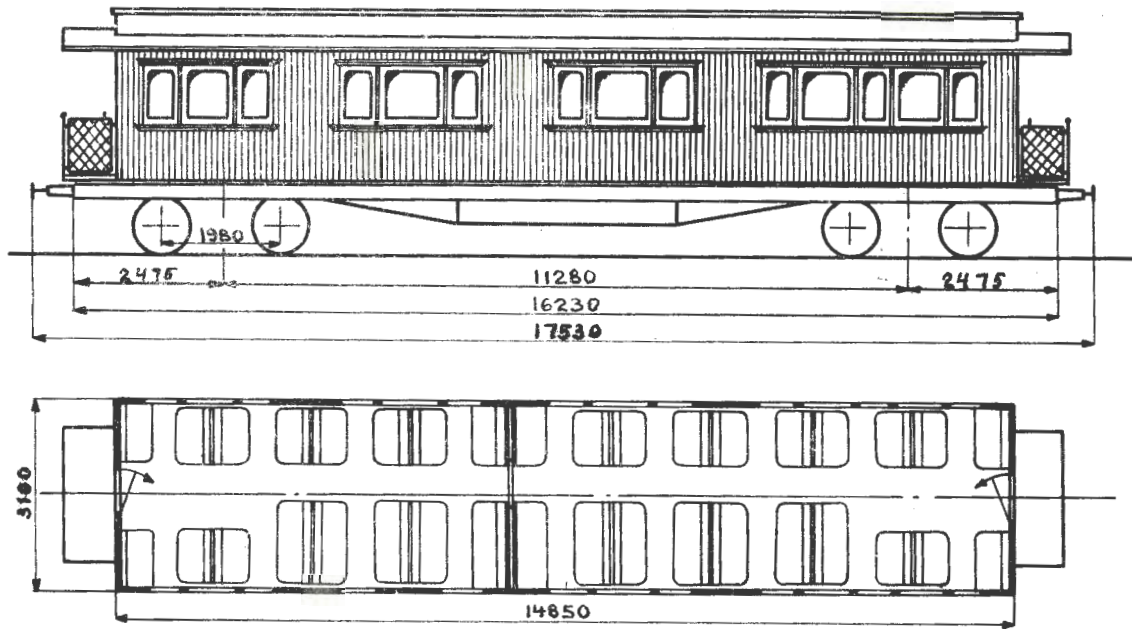

Oppr. hovedt. 187¹⁾

Vogn nr.	Distriktsmerke	Fabrikant	Byggeår	Omt. vognvekt i tonn	Sittepl. 2.klasse	Grunnriss	El. varme i kW	Vognutstyr (se side 6)	Merknad
320	0	Skb	93	23,0	84			1H.3.5.10.39a	
322	"	"	"	24,5	"			1H.3.5.10.39a	
323	"	"	"	28,0	"			1H.3.5.10.39a	
324	"	"	"	25,0	"			1H.3.5.10.39a	

1) Forandr. etter O.d. tegn. 1097
Trykk nr. 751 1.7.56

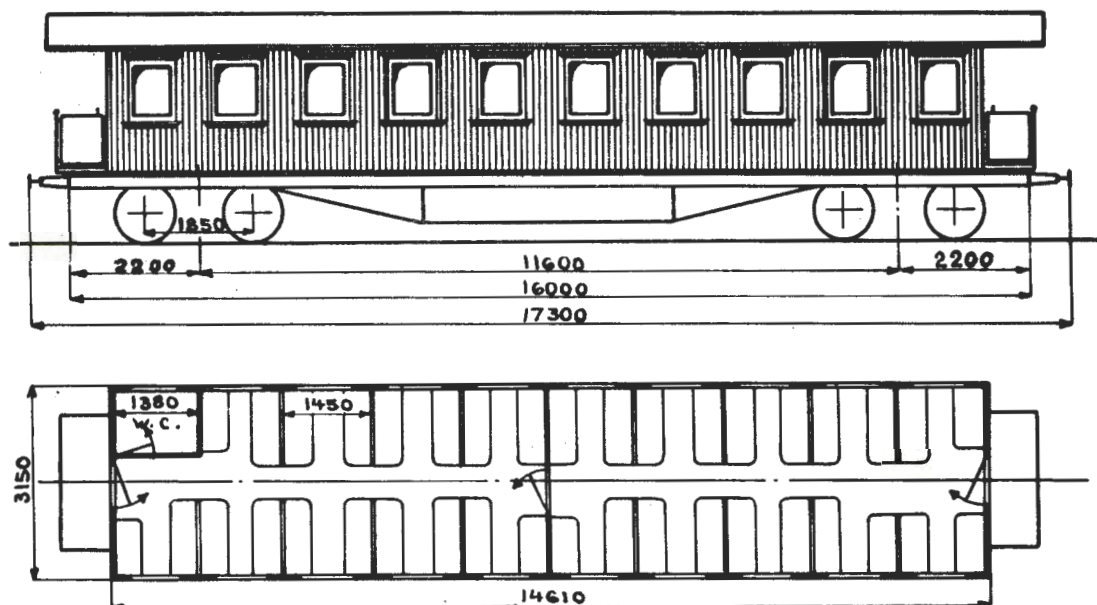

Hovedt. 2828

Vogn nr.	Distriktsmerke	Fabrikant	Byggeår	Omr. vognvekt i tonn	Sittepl. 2.klasse	Grunnriss	El. varme i kW	Vognutstyr (se side 6)	Merknad
127	0	Str	24	20,5	106			1H.3.5.13	
128	"	"	"	20,0	"			1H.3.5.13	
129	"	"	"	19,5	"			1H.3.5.8.13	
130	"	"	"	20,5	"			1H.3.5.8.13	
140	"	"	"	20,0	"			1H.3.5.13	1)
141	"	"	25	19,5	"			1H.3.5.13	
142	"	"	"	21,0	"			1H.3.5.13	
143	"	"	"	21,5	"			1H.3.5.10	
144	"	"	"	20,5	"			1H.3.5.13	
146	"	"	"	"	"			1H.3.5.13	
147	"	"	"	21,0	"			1H.3.5.13	
148	"	"	"	20,5	"			1H.3.5.13	
149	"	"	"	21,5	"			1H.3.5.13	
150	"	"	"	20,0	"			1H.3.5.13	1)
194	"	"	26	21,5	"			1H.3.5.13	
195	"	"	"	19,0	"			1H.3.5.13	
196	"	"	"	"	"			1H.3.5.13	
197	"	"	"	19,5	"			1H.3.5.13	
198	"	"	"	"	"			1H.3.5.10	

1) El. lys for tilkobl. til nabovg.
Trykk nr. 751 1.7.58

Bo4b

TYPE 1

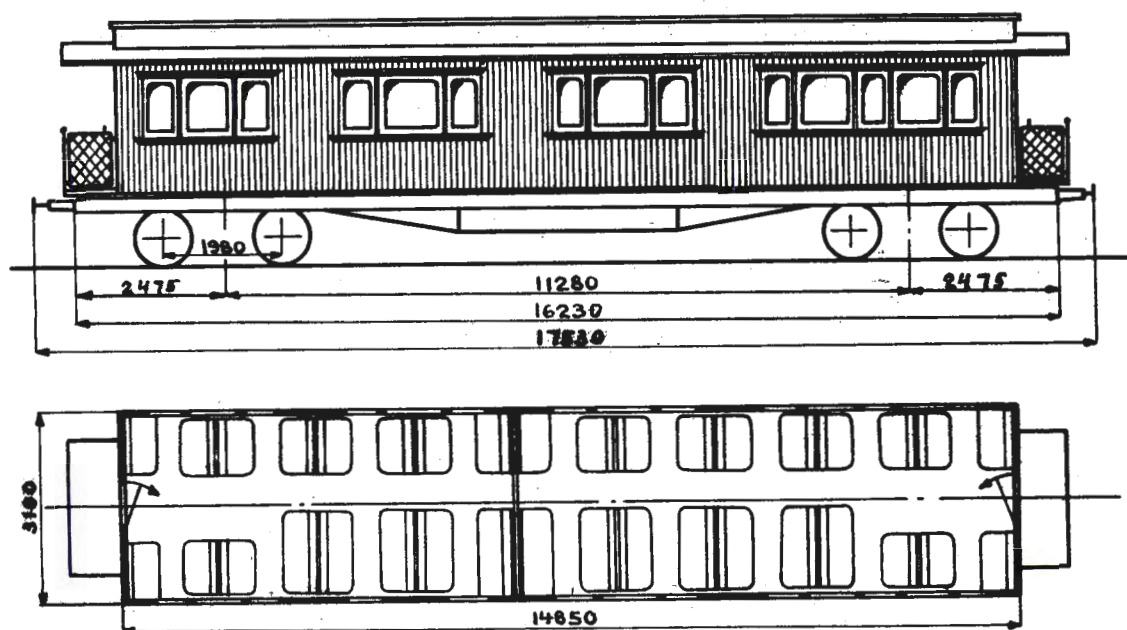

Oppr. hovedt. 187¹⁾

Vogn nr.	Distriktsmerke	Fabrikant	Byggeår	Omtr. vognvekt i tonn	Sittepl. 2.klasse	Grunnriss	El.varme i kW	Vognutstyr (se side 6)	Merknad
320	0	Skb	93	23,0	84			1H.3.5.10.39a	
322	"	"	"	24,5	"			1H.3.5.10.39a	
323	"	"	"	28,0	"			1H.3.5.10.39a	
324	"	"	"	25,0	"			1H.3.5.10.39a	

1) Forandr. etter O.d. tegn. 1097
Trykk nr. 751 1.7.56

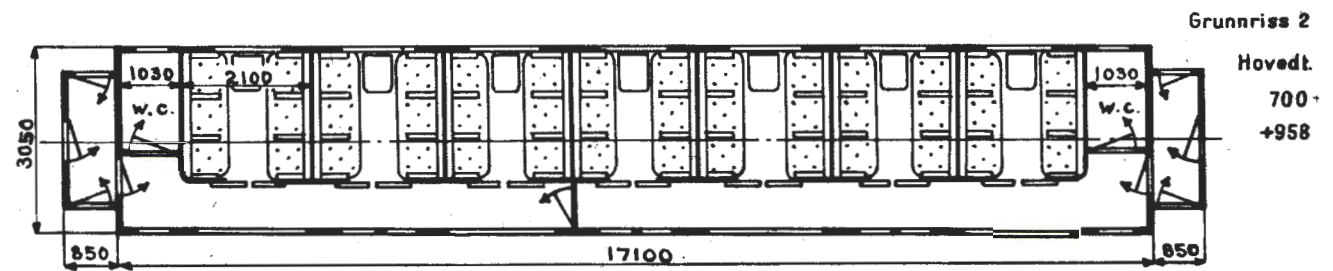
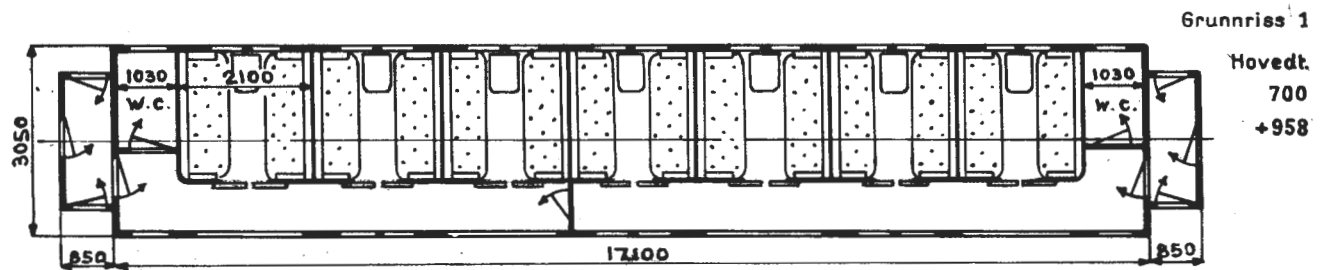
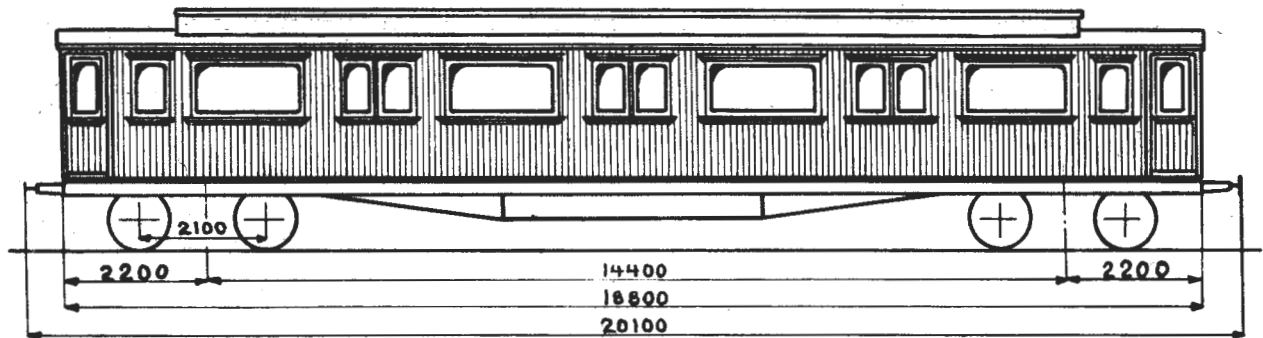

Vogn nr.	Distriktsmerke	Fabrikant	Byggeår	Omt. vognvekt i tonn	Sittepl. 1.klasse	Grunnriss	El. varme i kW	Vognutstyr (se side 6)	Merknad
501	D	Skb	09	30,0	42	2		1H.3.5.12.28.39a	
502	"	"	"	31,5	"	1		1H.3.5.11.28.39a	

Ao2b

TYPE 1

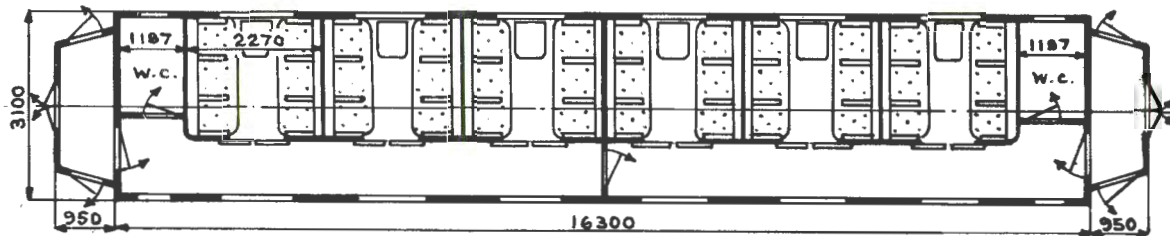
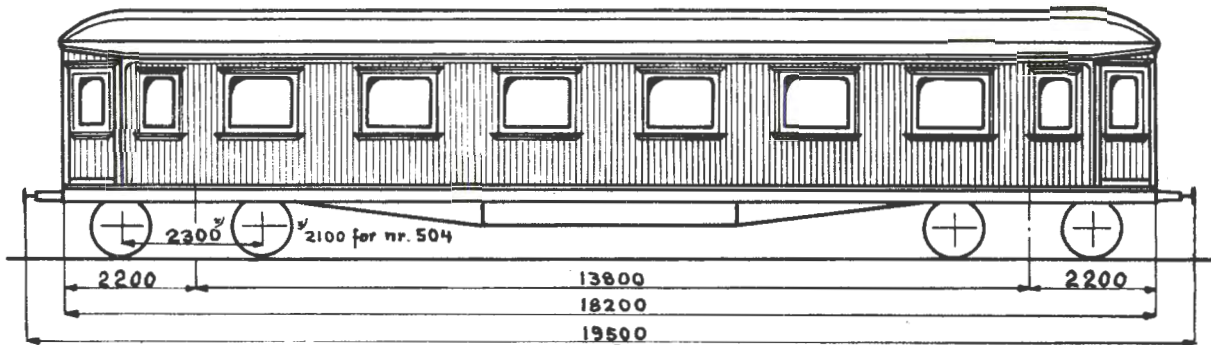

Hovedt. 1844
2026

Vogn nr.	Distriktsmerke	Fabrikant	Byggeår	Omt. vognvekt i tonn	Sittepl. 1.klasse	Grunnriss	El.varme i kW	Vognutstyr (se side 6)	Merknad
504	D	Str	09	30,5	36			1H.3.5.11.28.39a	Oppr. hovedt. 699. Ny vognkasse U Hovedt. 2026
247	O	"	13	34,5	"			1KK.3.5.11.28.35.39a	
209	"	"	15	"	"			1KK.3.5.11.28.35.39a	
18035	F	Skb	19	33,5	"			1H.3.5.11.28.39a	Hovedt. 1844
18064	D	"	21	34,0	"			1H.3.5.11.28.39a	

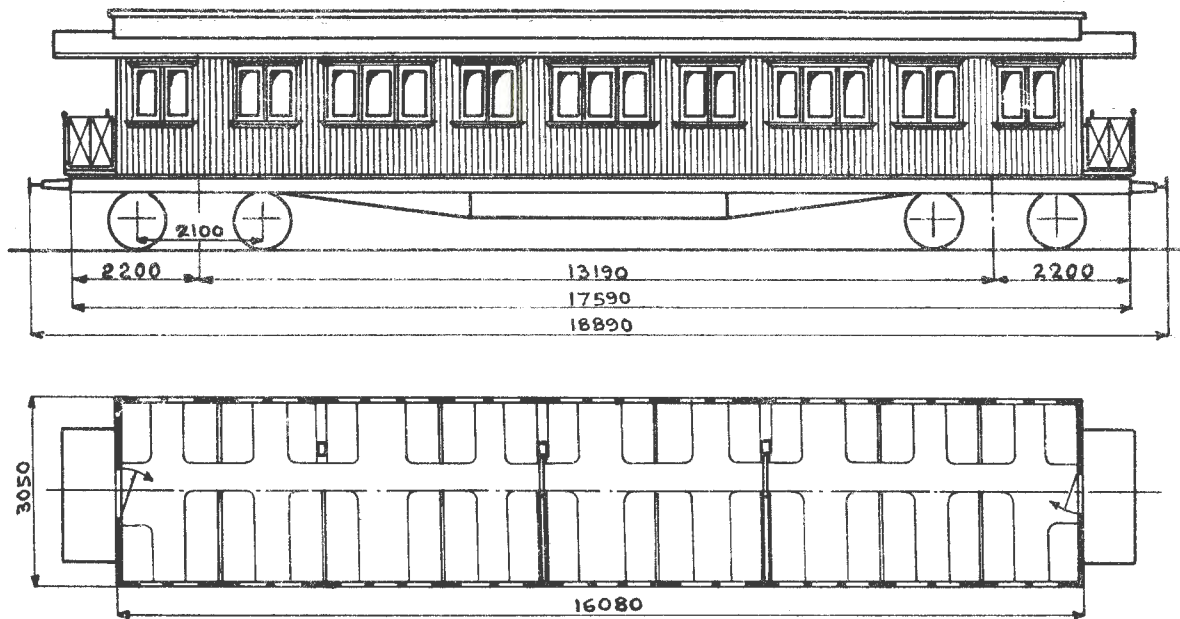

Hovedt. B. 127

Vogn nr.	Distriktsmerke	Fabrikant	Byggeår	Omr. vognvekt i tonn	Sittepl. 2.klasse	Grunnriss	El. varme i kW	Vognutstyr (se side 6)	Merknad
77	0	Str	03	26,0	88			1H.3.5.11.39a	

Bo 4b

TYPE 3

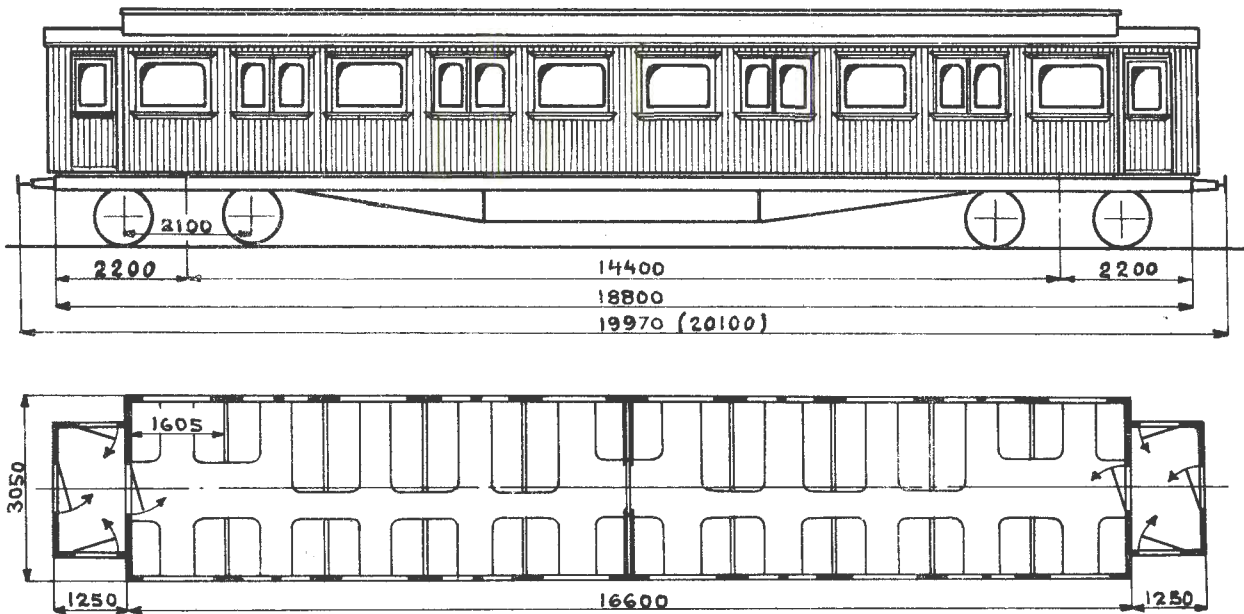

Hovedt. 704

Vogn nr.	Distriktsmerke	Fabrikant	Byggeår	Omtr. vognvekt i tonn	Sittepl. 2.klasse	Grunnriss	El.varme i kW	Vognutstyr (se side 6)	Merknad
966	B	Str	04	26,0	92			1H.3.5.11.39a	Ny vognkasse etter tegn. 5897
967	"	"	"	26,5	"			1H.3.5.11.39a	
968	"	"	"	"	"			1H.3.5.11.39a	
969	"	"	"	27,5	"			1H.3.5.11.39a	
970	"	"	"	25,0	"			1H.3.5.11.39a	

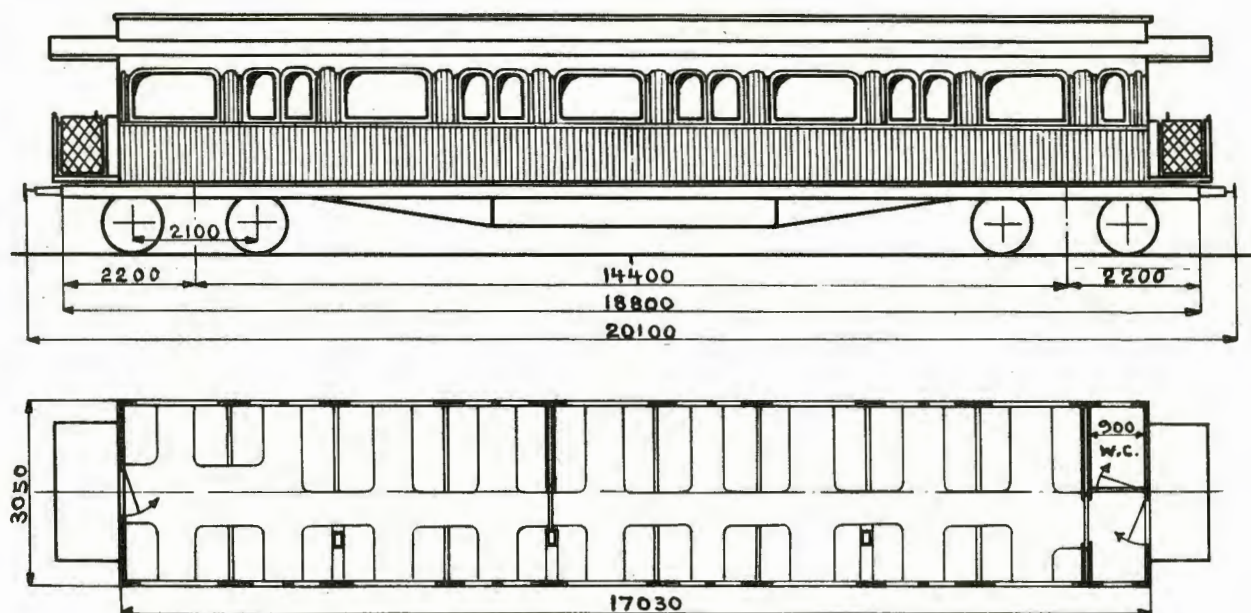

Hovedt. B. 175

Vogn nr.	Distriktsmerke	Fabrikant	Byggeår	Omtr. vognvekt i tonn	Sittepl. 2.klasse	Grunnriss	E. varme i kW	Vognutstyr (se side 6)	Merknad
78	0	Str	07	27,5	86			1H.3.5.11.39a	
79	=	=	=	28,5	=			1H.3.5.11.39a	

Bo4c

TYPE 1

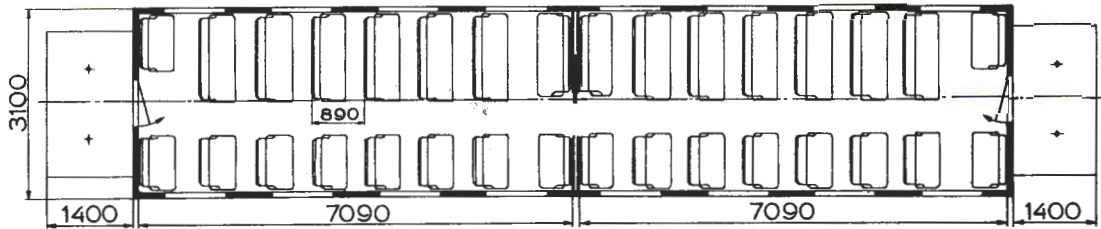
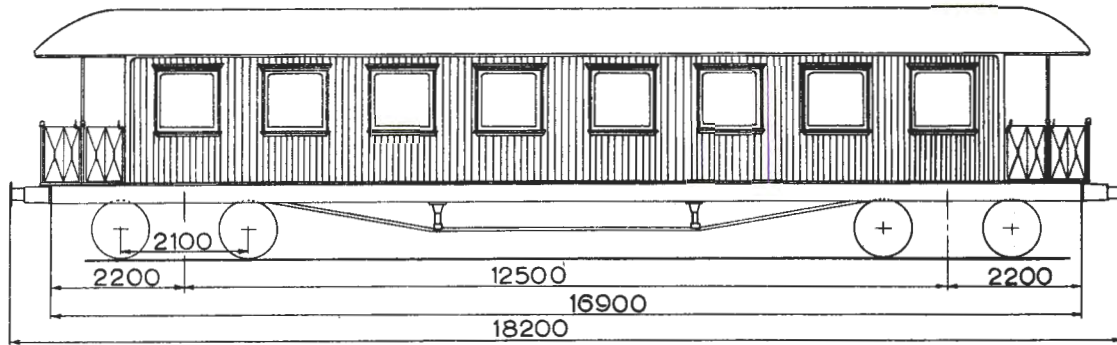

Hovedt. 2369

Vogn nr.	Distriktsmerke	Fabrikant	Byggeår	Omt. vognvekt i tonn	Sittepl. 2.klasse	Grunnriss	El. varme i kW	Vognutstyr (se side 6)	Merknad
39	0	SJv	20	28,5	78			1H.3.5.11.39a	
44	"	"	"	"	"			1H.3.5.11.39a	
47	"	"	"	"	"			1H.3.5.11.39a	
586	D	Scd	"	28,0	"			1H.3.5.11.39a	
587	"	"	"	28,5	"			1H.3.5.11.39a	
601	"	Skb	22	28,0	"			1H.3.5.11.39a	
605	"	SMv	21	27,5	"			1H.3.5.11.39a	
606	"	"	"	"	"			1H.3.5.11.39a	
607	"	"	"	28,0	"			1H.3.5.11.39a	
608	"	"	"	28,5	"			1H.3.5.11.39a	
609	"	"	"	28,0	"			1H.3.5.11.39a	
610	"	"	"	27,5	"			1H.3.5.11.39a	

Trykk nr. 751 1.7.57

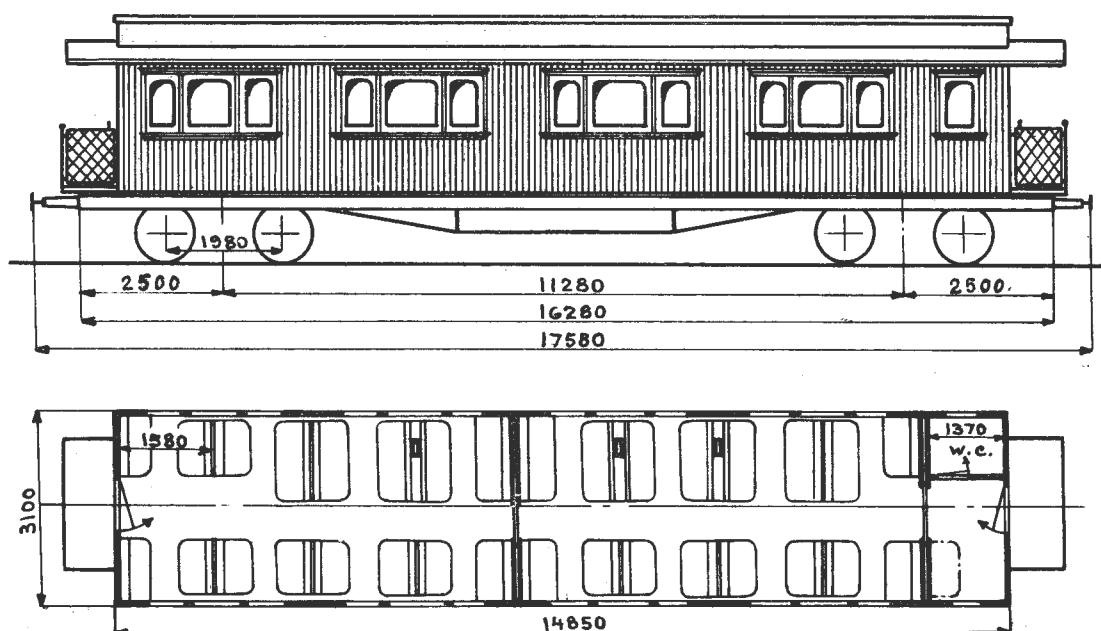

Oppr. hovedt. $\left. \begin{matrix} 208 \\ 220 \end{matrix} \right\}^1$

Vogn nr.	Distriktsmerke	Fabrikant	Byggeår	Omtr. vognvekt i tonn	Sittepl. 2.klasse	Grunnriss	El. varme i kW	Vognutstyr (se side 6)	Merknad
161	0	Kok	90	26,5	78			1H.3.5.7.10.39a	
474	"	Str	93	25,0	"			1H.3.5.10.39a	
475	K	"	"	26,0	"			1H.3.5.7.10	
478	0	Skb	"	25,5	"			1H.3.5.10.39a	

1) Forandr. etter O.d. tegn. 1800
Trykk nr. 751 1.7.56

Bo4d

TYPE 2

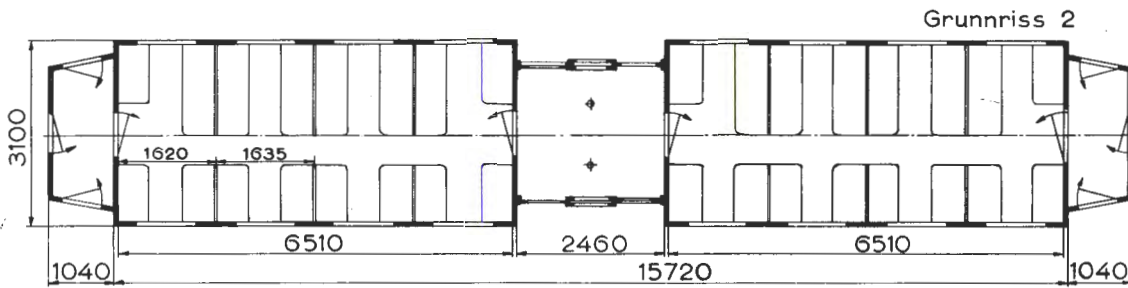
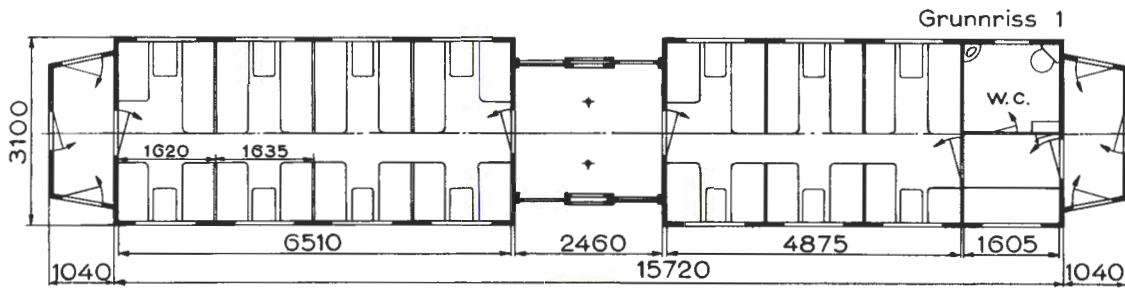
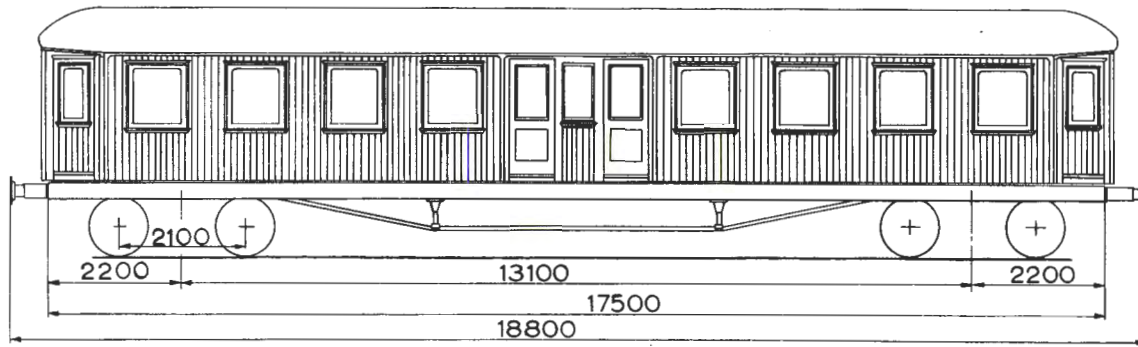

Oppr. hovedt. 2845

Vogn nr.	Distriktsmerke	Fabrikant	Byggeår	Omr. vognvekt i tonn	Sittepl. 2.klasse	Grunnriss	El.varme i kW	Vognutstyr (se side 6)	Merknad
18118	B	Skb	25	26,5	76	2		1H. 3. 5. 10.	
18119	"	"	"	270	"	"		1H. 3. 5. 11.	
18120	"	"	"	26,5	66	1		1H. 3. 5. 10.	
18121	"	"	26	"	76	2		1H. 3. 5. 11.	
18122	"	"	"	270	"	"		1H. 3. 5. 11.	
18123	"	"	"	26,5	"	"		1H. 3. 5. 10.	
18124	"	"	"	260	"	"		1H. 3. 5. 11.	

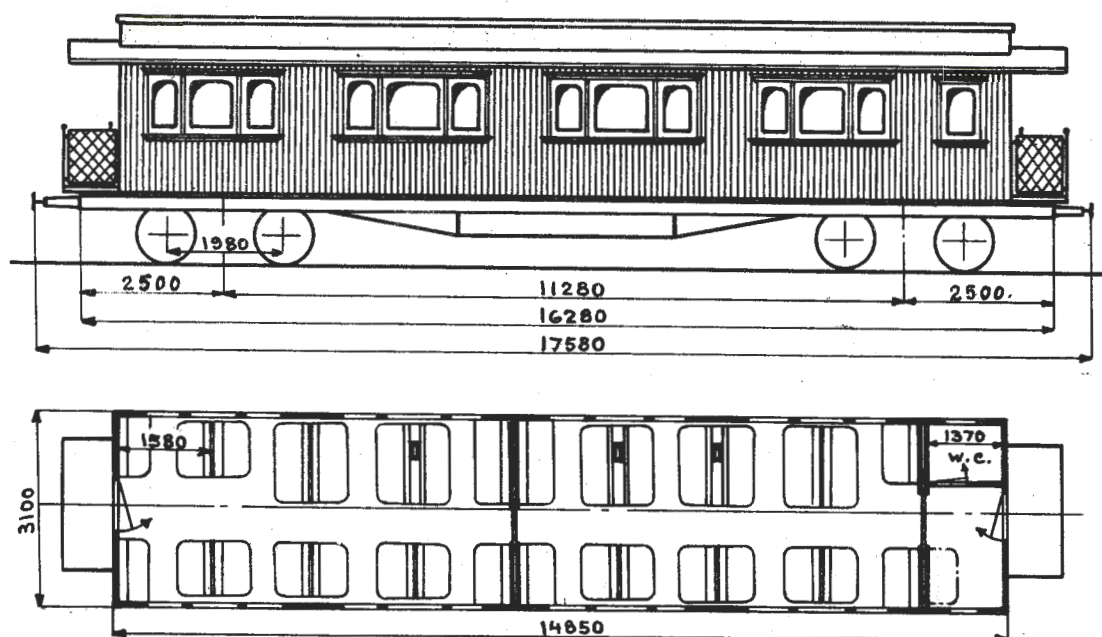

Oppr. hovedt. 208¹⁾
220¹⁾

Vogn nr.	Distriktsmerke	Fabrikant	Byggeår	Omr. vognvekt i tonn	Sittepl. 2.klasse	Grunnriss	El. varme i kW	Vognutstyr (se side 6)	Merknad
161	O	Kok	90	26,5	78			1H.3.5.7.10.39a	
474	"	Str	93	25,0	"			1H.3.5.10.39a	
475	K	"	"	26,0	"			1H.3.5.7.10	
478	O	Skb	"	25,5	"			1H.3.5.10.39a	

1) Forandr. etter O.d. tegn. 1800
Trykk nr. 751 1.7.56

Bo4d

TYPE 2

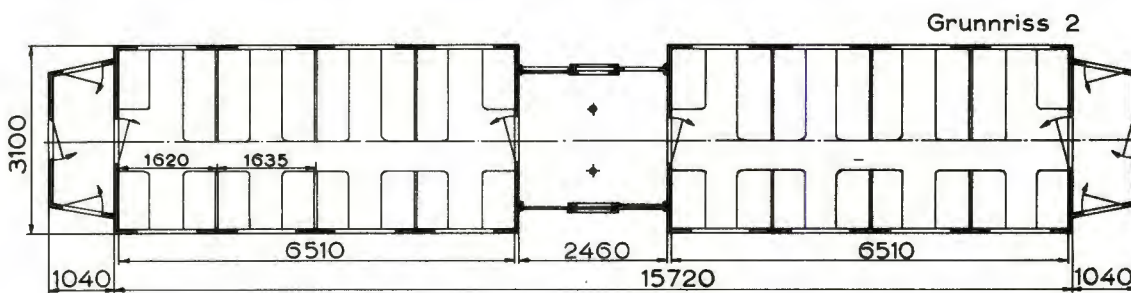
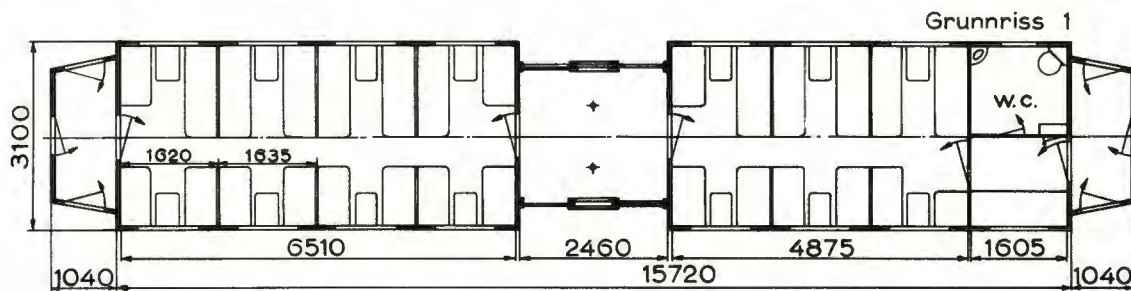
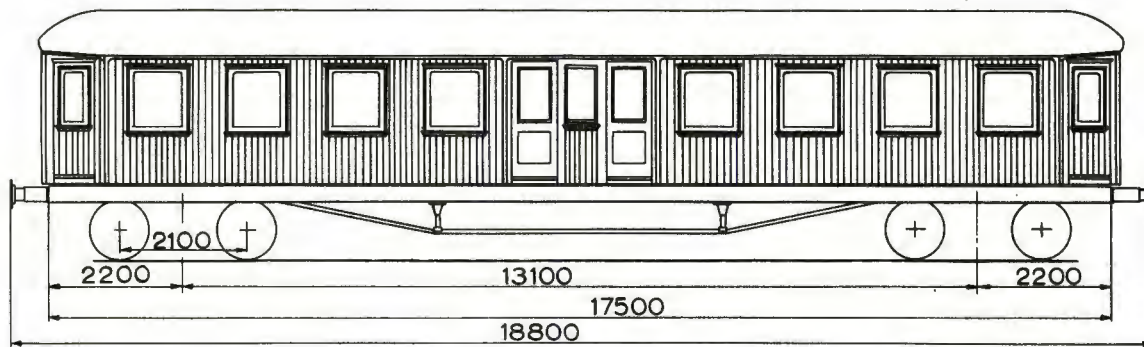

Oppr. hovedt. 2845

Vogn nr.	Distriktsmerke	Fabrikant	Byggeår	Omr. vognvekt i tonn	Sittepl. 2.klasse	Grunnriss	El. varme i kW	Vognutstyr (se side 6)	Merknad
18118	B	Skb	25	26,5	76	2		1H. 3. 5. 10.	
18119	"	"	"	27,0	"	"		1H. 3. 5. 11.	
18120	"	"	"	26,5	66	1		1H. 3. 5. 10.	
18121	"	"	26	"	"	"		1H. 3. 5. 11.	
18122	"	"	"	27,0	76	2		1H. 3. 5. 11.	
18123	"	"	"	26,5	"	"		1H. 3. 5. 10.	
18124	"	"	"	26,0	"	"		1H. 3. 5. 11.	

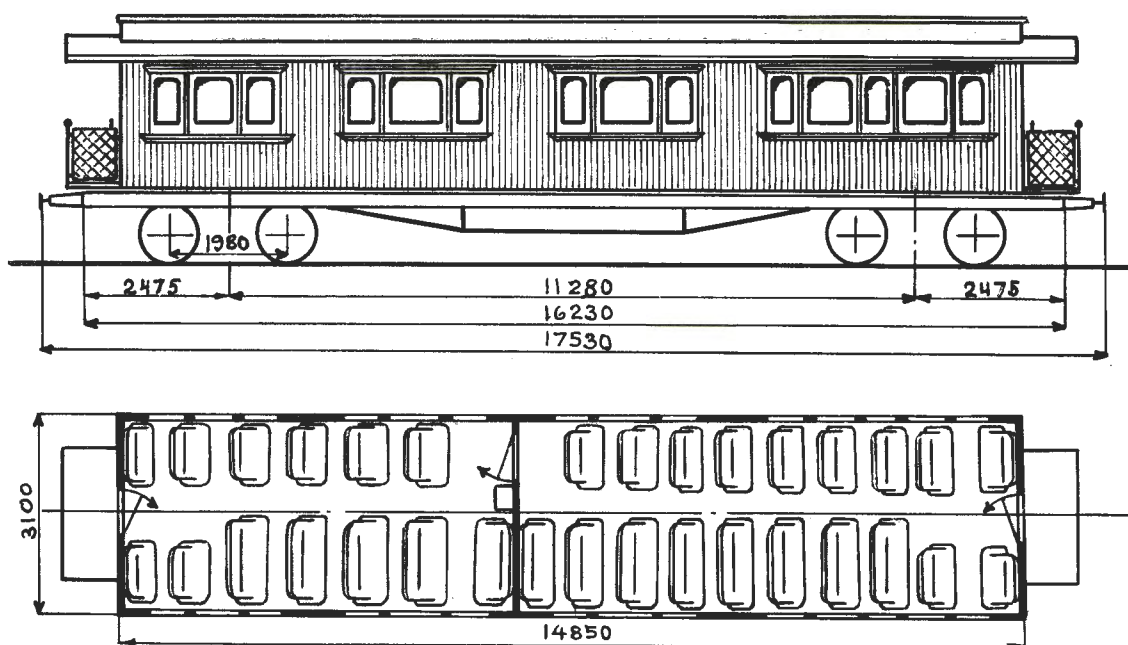

Oppr. hovedt. 187

Vogn nr.	Distriktsmerke	Fabrikant	Byggeår	Omtr. vognvekt i tonn	Sittepl. 2.klasse	Grunnriss	El. varme i kW	Vognutstyr (se side 6)	Merknad
318	S	Skb	93	26,5	77			1H.3.5.10	

Bo4d

TYPE 5

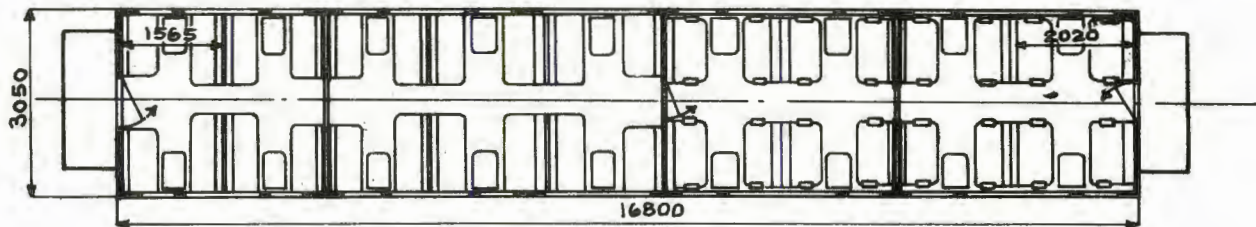
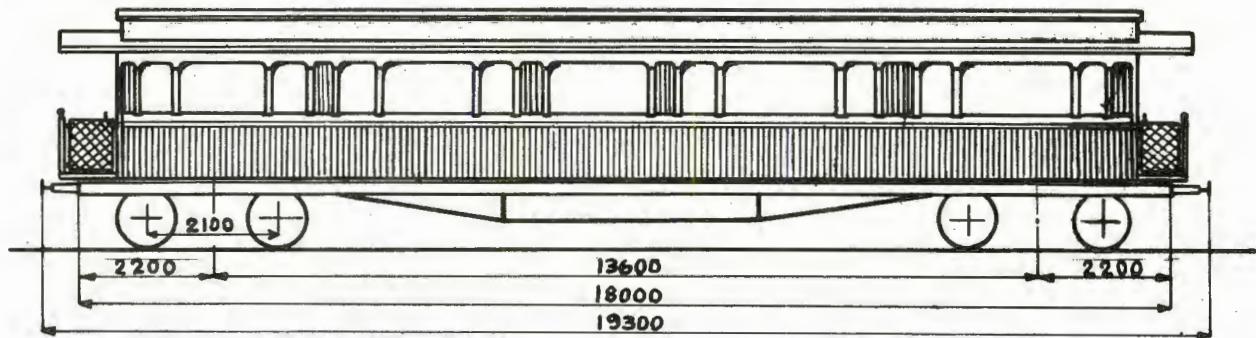

Oppr. hovedt. Skabo D/154

Vogn nr.	Distriktsmerke	Fabrikant	Byggeår	Omr. vognvekt i tonn	Sittepl. 2.klasse	Grunnriss	El.varme i kW	Vognutstyr (se side 6)	Merknad
233	0	Skb	05	27,0	72			1H.3.5.11.39a	

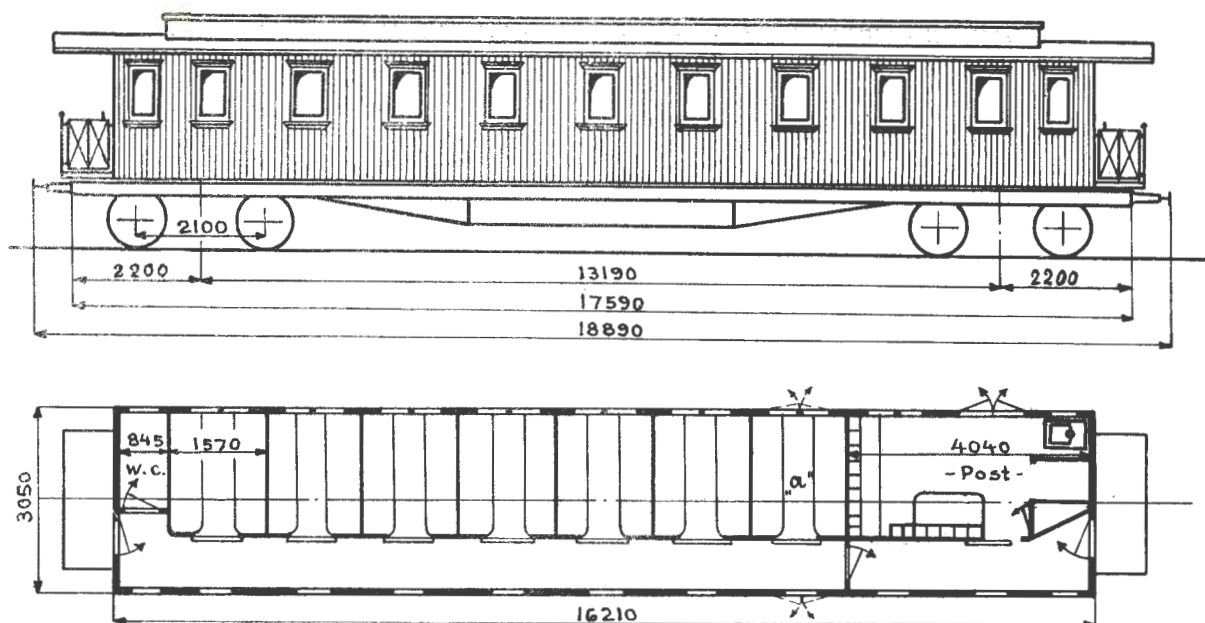
Oppr. hovedt. 439¹⁾

Vogn nr.	Distriktsmerke	Fabrikant	Byggear	Omr. vognvekt i tonn	Sittepl. 2.klasse	Post, last i tonn	Grunnriss	El. varme i kW	Vognutstyr (se side 6)	Merknad
339	0	Str	01	27,5	56	1,5			1H.3.5.8.11	Sykekupé "a"
340	"	"	03	"	"	"			1H.3.5.8.11.40	

1) Forandr. etter Hmr d. tegn. 4023

BDo2 -11

TYPE 1

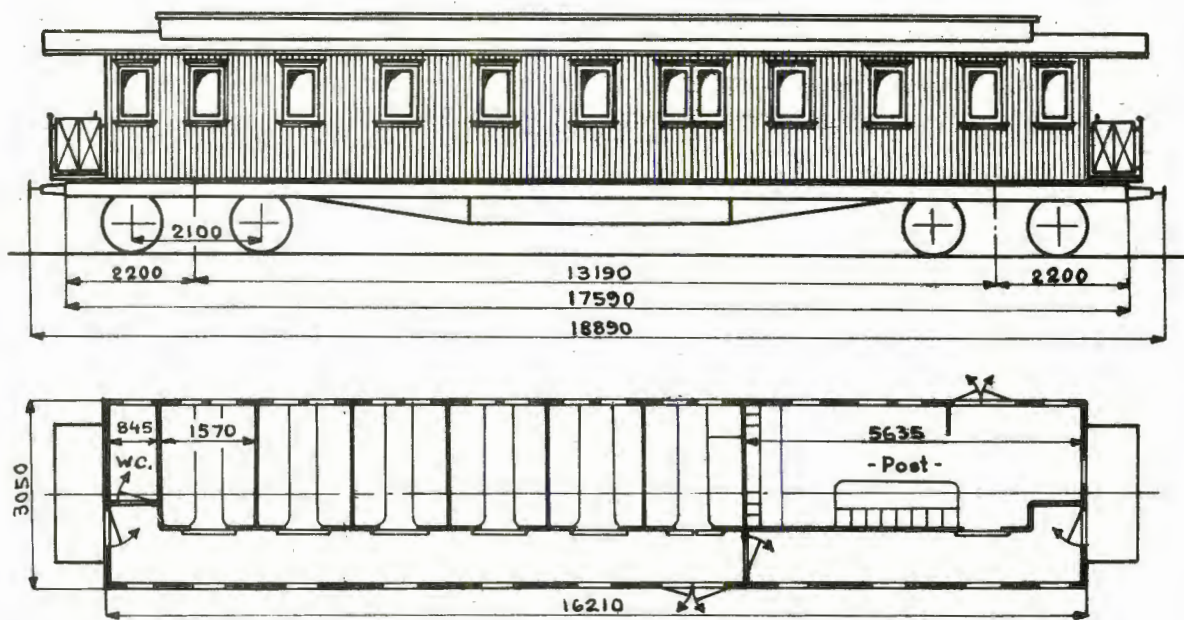

Oppr. hovedt. 439

Vogn nr.	Distriktsmerke	Fabrikant	Byggeår	Omr. vognvekt i tonn	Sittepl. 2.klasse	Post. last i tonn	Grunnriss	El. varme i kW	Vognutstyr (se side 6)	Merknad
913	H	Str	01	26,5	48	2,5			1H.3.5.8.11.41	

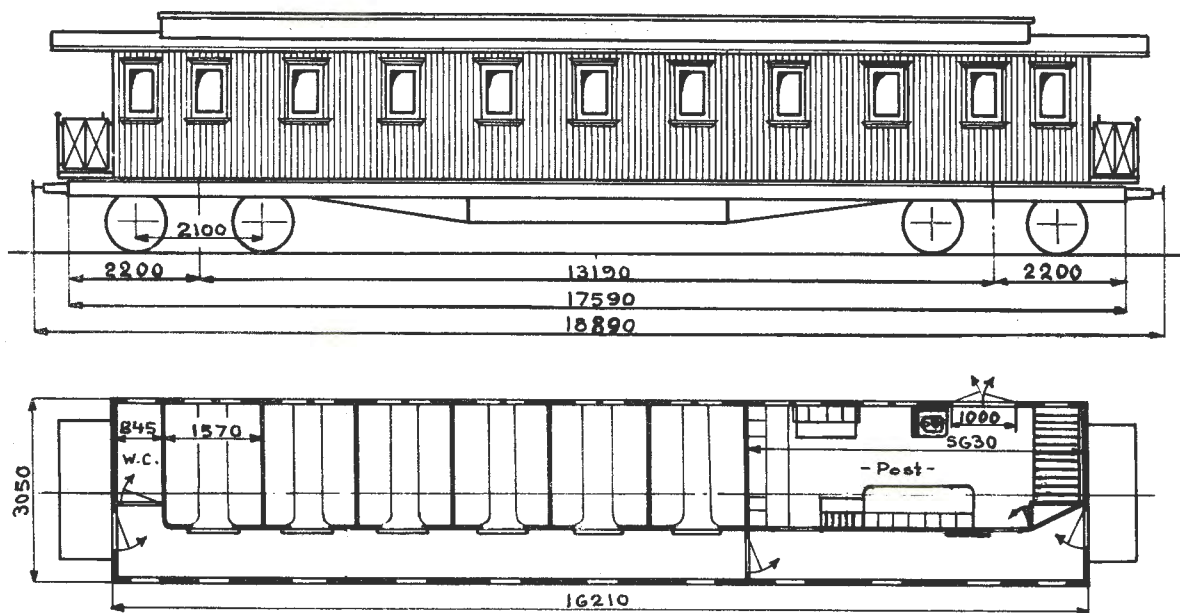

Oppr. hovedt. 439¹⁾

Vogn nr.	Distriktsmerke	Fabrikant	Byggear	Omr. vognvekt i tonn	Sittepl. 2.klasse	Post, last i tonn	Grunnriss	El. varme i kW	Vognutstyr (se side 6)	Merknad
338	0	Str	01	27,0	48	2,5			1H.3.5.8.11	

1) Forandr. etter skisse 1058
Trykk nr. 751 1.7.56

BDo2-16

TYPE 1

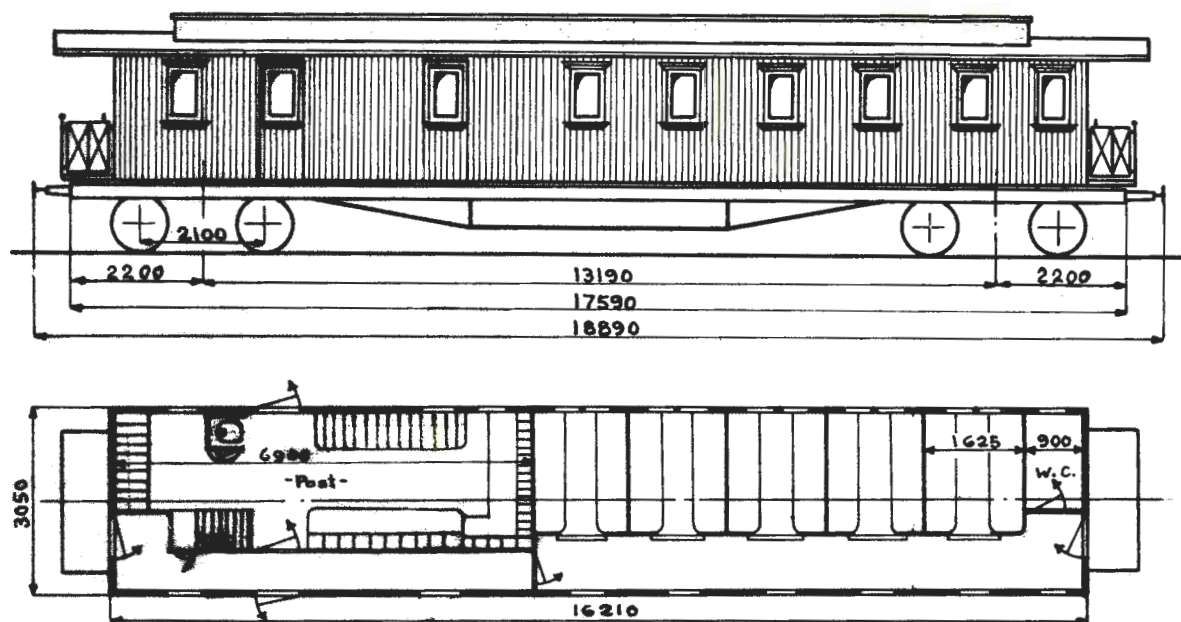

Oppr. hovedt. 460¹⁾

Vogn n.	Distriktsmerke	Fabrikant	Byggeår	Omtr. vognvekt i tonn	Sittepl. 2.klasse	Post, last i tonn	Grunnriss	El-varme i kW	Vognutstyr (se side 6)	Merknad
182	0	Skb	00	27,0	40	2,0			1H.3.5.8.11.39a	

1) Forandr. etter tegn. 6726
Trykk nr. 751 1.7.56

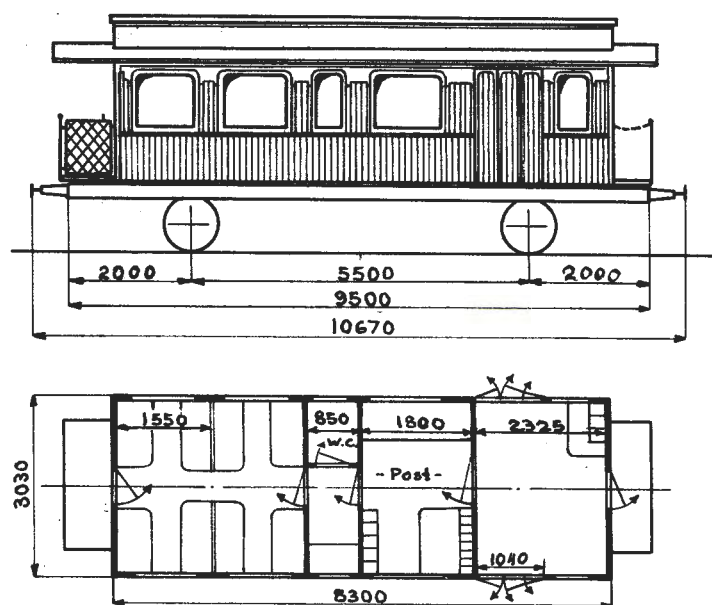

Oppr. hovedt. Skabo D/198

Vogn nr.	Distriktsmerke	Fabrikant	Byggeår	Omtr. vognvekt i tonn	Sittepl. 2.klasse	Post, last i tonn	Reisegods, last i tonn	Grunnriss	El. varme i kW	Vognutstyr (se side 6)	Merknad
18113	D	Skb	08	12,0	16	1,0	1,0			1H.3.7.8.10	

BDFo2-4

TYPE 1

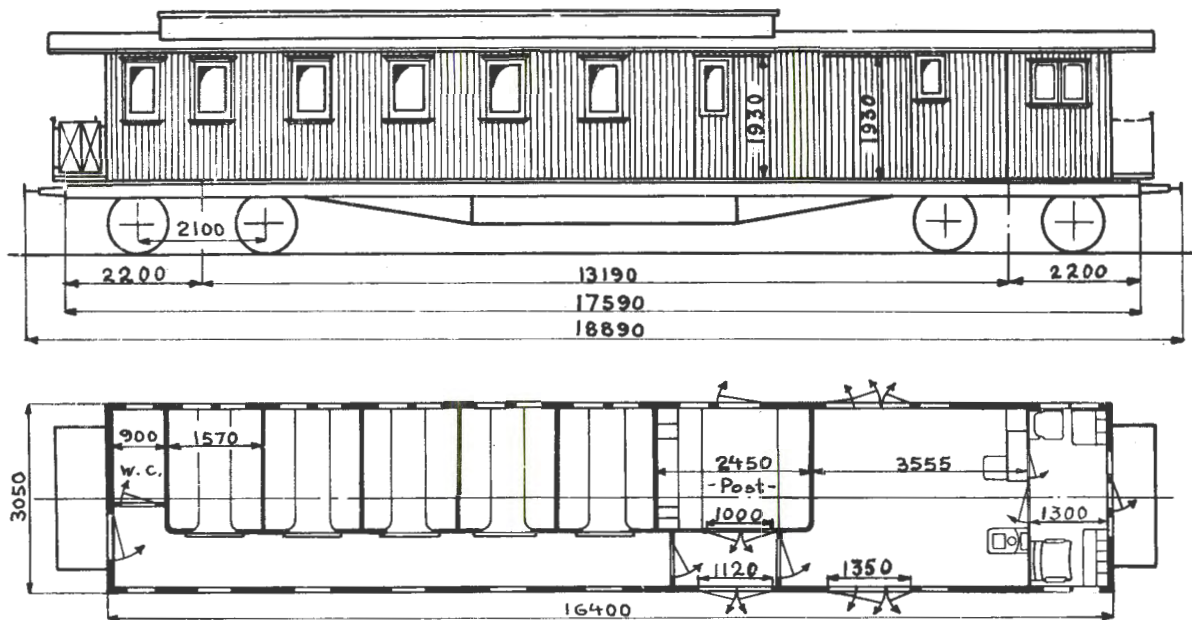

Hovedt. 625

Vogn nr.	Distriktsmerke	Fabrikant	Byggeår	Omr. vognvekt i tonn	Sittepl. 2.klasse	Post, last i tonn	Reisegods, last i tonn	Grunnriss	El.varme i kW	Vognutstyr (se side 6)	Merknad
916	0	Skb	01	28,0	40	0,3	2,0			1H.3.6.7.8.11	

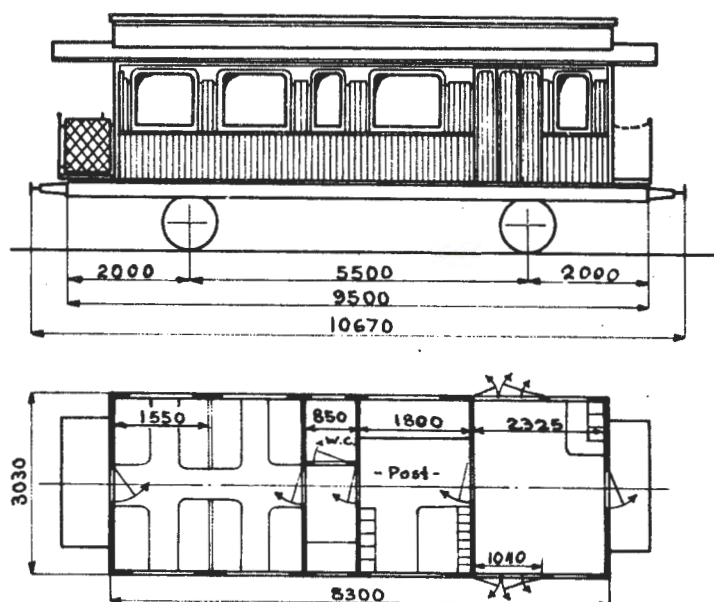

Oppr. hovedt. Skabo D/198

Vogn nr.	Distriktsmerke	Fabrikant	Byggeår	Omr. vognvekt i tonn	Sittepl. 2.klasse	Post, last i tonn	Reisegods, last i tonn	Grunnriss	El.varme i kW	Vognutstyr (se side 6)	Merknad
18113	D	Skb	08	12,0	16	1,0	1,0			1H.3.7.8.11	

BDFo2-4

TYPE 1

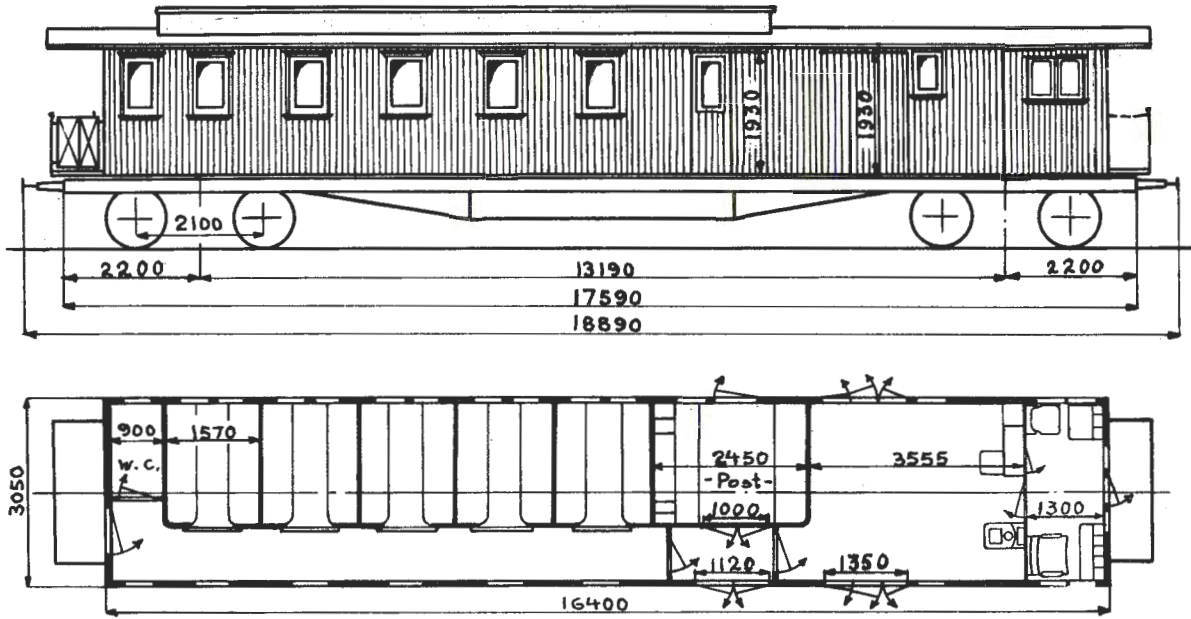

Hovedt. 625

Vogn nr.	Distriktsmerke	Fabrikant	Byggeår	Omr. vognvekt i tonn	Sittepl. 2.klasse	Post, last i tonn	Reisegods, last i tonn	Grunnriss	El. varme i kW	Vognutstyr (se side 6)	Merknad
916	0	Skb	01	28,0	40	0,3	2,0			1H.3.6.7.8.11	

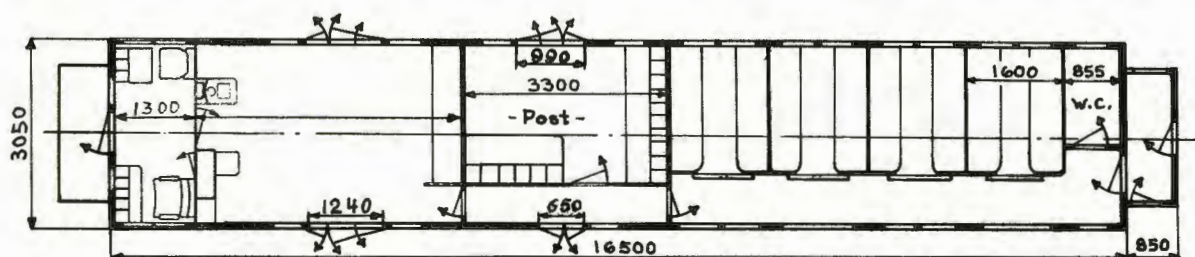
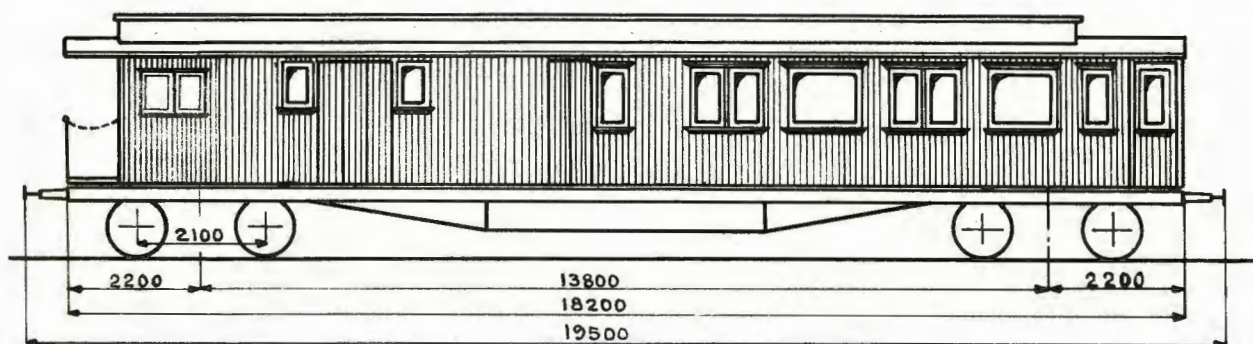

Hovedt. 701

Vogn nr.	Distriktsmerke	Fabrikant	Byggeår	Omr. vognvekt i tonn	Sittepl. 2.klasse	Post, last i tonn	Reisegods, last i tonn	Grunnriss	El. varme i kW	Vognutstyr (se side 6)	Merknad
514	D	Skb	09	29,0	32	0,5	2,0			1H.3.5.7.11.39a	
515	"	"	"	"	"	"	"			1H.3.5.7.8.11.39a	
963	B	"	04	26,5	"	"	"			1H.3.5.8.11.28.39a	
964	K	"	"	28,5	"	"	"			1H.3.5.7.8.11.39a	

BDFo2-7

TYPE 2

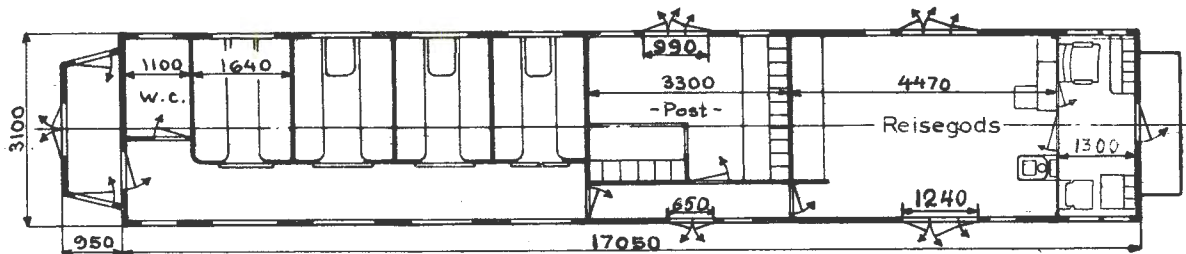
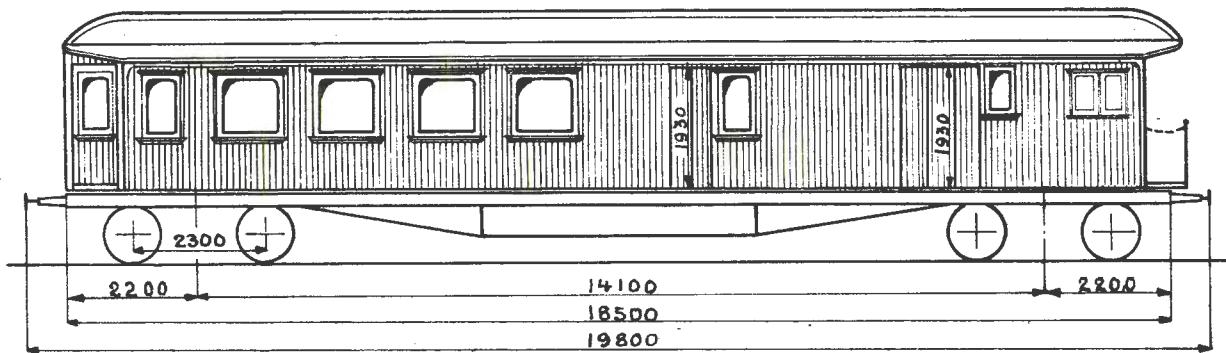

Hovedt. 1928

Vogn nr.	Distriktsmerke	Fabrikant	Byggeår	Omt. vognvekt i tonn	Sittepl. 2.klasse	Post, last i tonn	Reisegods, last i tonn	Grunnriss	El. varme i kW	Vognutstyr (se side 6)	Merknad
18029	T	Skb	16	32,0	32	1,5	3,0			1H.3.5.7.8.11.28	
18081	B	SJv	21	34,0	"	"	"			1H.3.5.7.8.11.39a	
18082	"	"	"	33,0	"	"	"			1H.3.5.7.8.11.28.39a	
18083	"	"	"	34,0	"	"	"			1H.3.5.7.8.11.28.39a	
18092	T	"	"	32,0	"	"	"			1H.3.5.7.8.11.28	

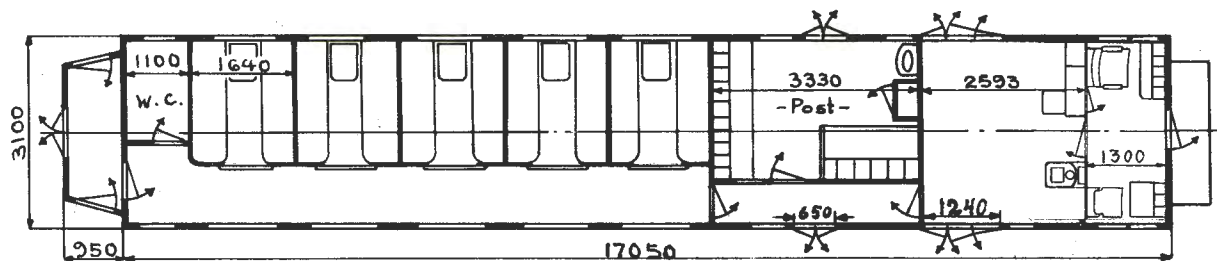
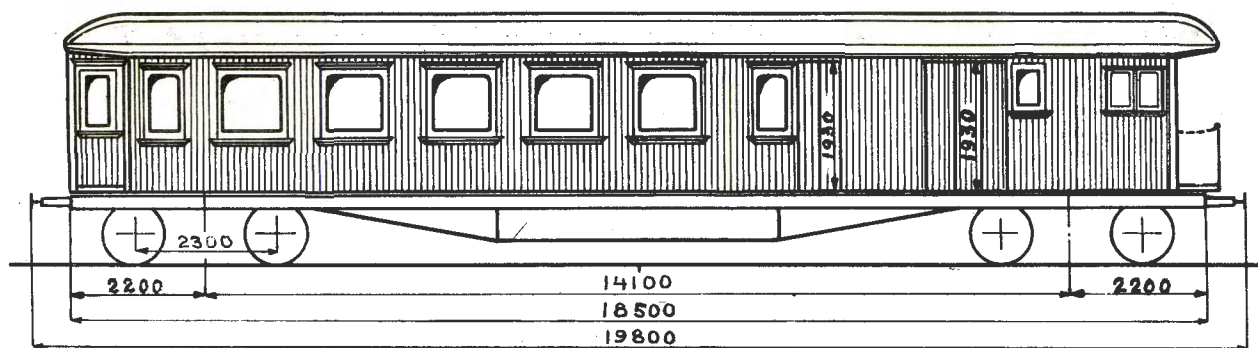

Oppr. hovedt. 2126

Vogn nr.	Distriktsmerke	Fabrikant	Byggeår	Omr. vognvekt i tonn	Sittepl. 2.klasse	Post, last i tonn	Reisegods, last i tonn	Grunnriss	El.varme i kW	Vognutstyr (se side 6)	Merknad
18016	D	Skb	15	32,0	40	1,5	2,0			1H.3.5.7.8.11.28.39a	
18017	=	"	"	33,0	"	"	"			1H.3.5.7.8.11.28.39a	

BDFo2-11

TYPE 1

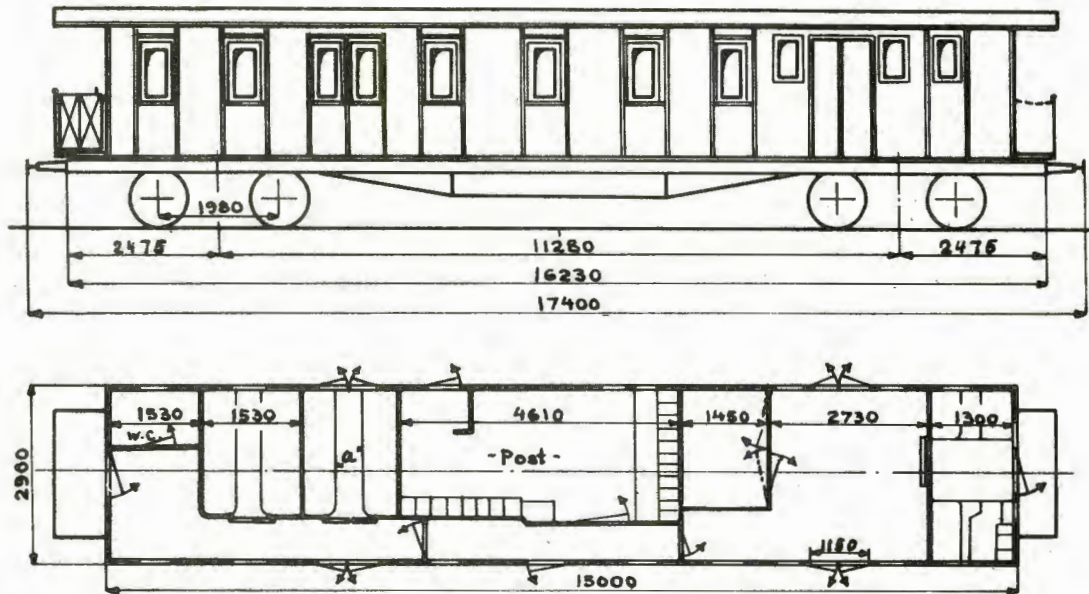

Oppr. hovedt. 220

Vogn nr.	Distriktsmerke	Fabrikant	Byggeår	Omr. vognvekt i tonn	Sittepl. 2.klasse	Post, last i tonn	Reisegods, last i tonn	Grunnriss	El. varme i kW	Vognutstyr (se side 6)	Merknad
802	H	Skb	93	24,0	16	2,0	1,5			1H.3.5.7.8.11	Sykekupé "a"

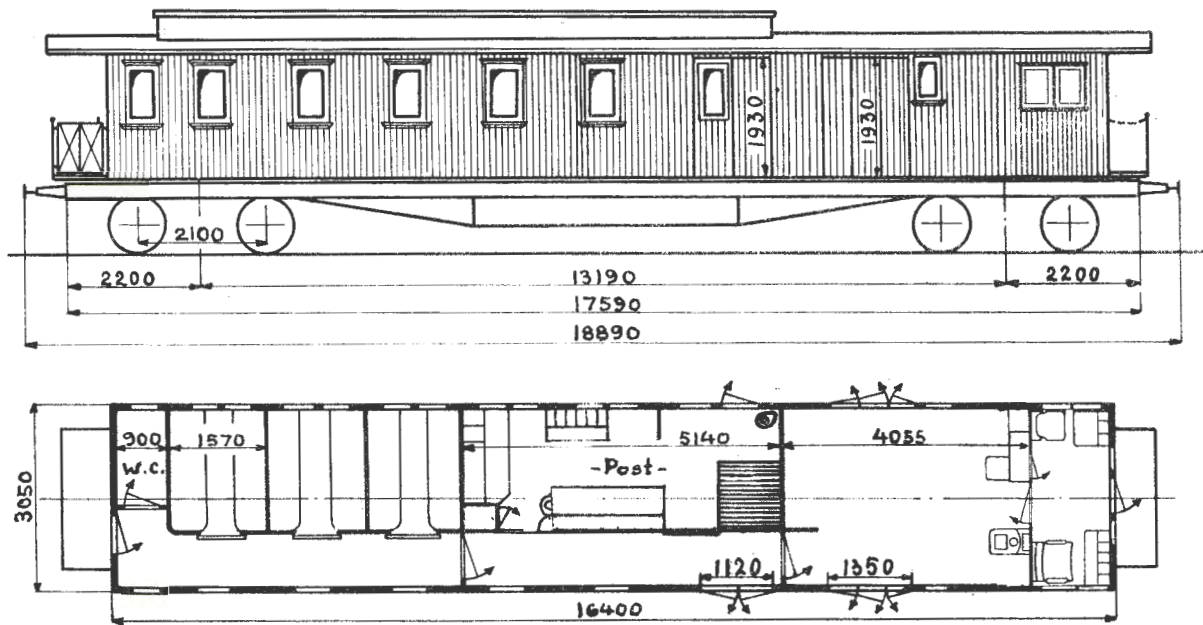

Oppr. hovedt. 625¹⁾

Vogn nr.	Distriktsmerke	Fabrikant	Byggear	Omr. vognvekt i tonn	Sittepl. 2.klasse	Post, last i tonn	Reisegods, last i tonn	Grunnriss	El.varme i kW	Vognutstyr (se side 6)	Merknad
917	0	Skb	01	27,5	24	1,0	2,0			1H.3.5.8.11.39a	

1) Forandr. etter tegn. 6667
Trykk nr. 751 1.7.56

BDFo2-11

TYPE 3

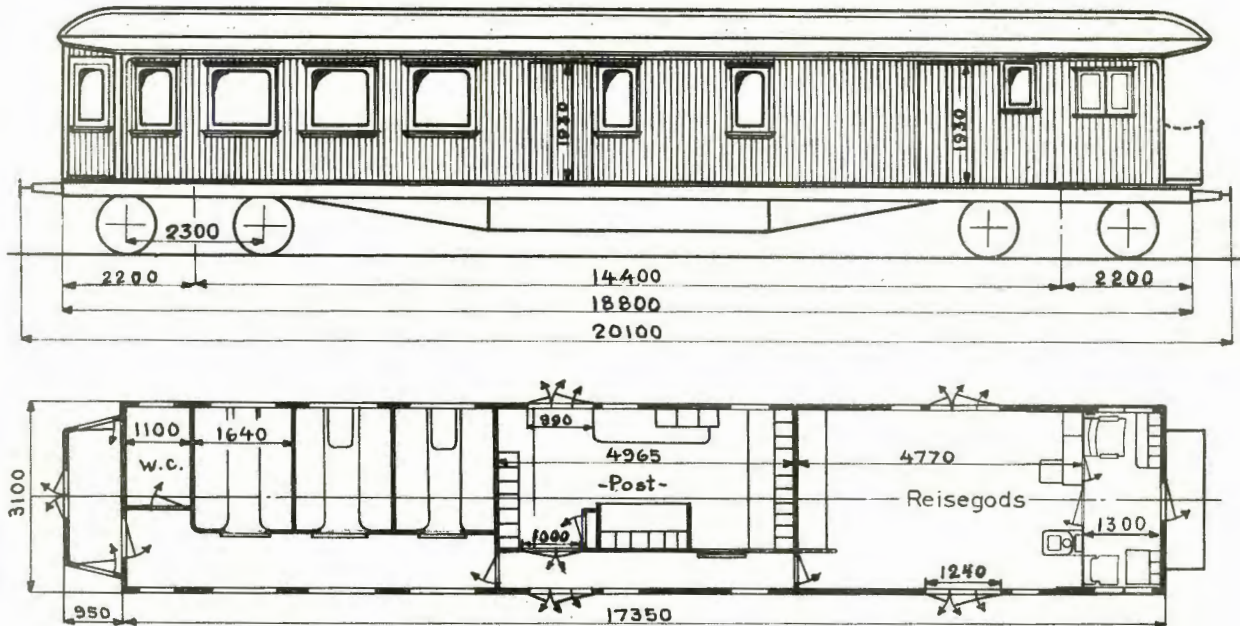

Hovedt. 1954
2442

Vogn nr.	Distriktsmerke	Fabrikant	Byggeår	Omr. vognvekt i tonn	Sittepl. 2.klasse	Post, last i tonn	Reisegods, last i tonn	Grunnriss	El.varme i kW	Vognutstyr (se side 6)	Merknad
18034	D	Skb	16	32,5	24	1,5	3,5			1H.3.5.8.11.28.39a	Hovedt. 1954 Postr. forandr. e. sk. 1194
18085	"	SJv	20	33,0	"	"	"			1H.3.5.7.8.11.28.39a	
18086	"	"	"	31,5	"	"	"			1H.3.5.8.11.28.39a	
18090	T	"	"	33,0	"	"	"			1H.3.5.8.11.28.39a	Postr. forandr. e. sk. 1025
620	D	SMv	21	32,5	"	"	"			1H.3.5.8.11.28.39a	" " " " 1061
621	"	"	"	33,0	"	"	"			1H.3.5.8.11.28.39a	
18109	T	Str	23	32,0	"	"	"			1H.3.5.8.11.39a	

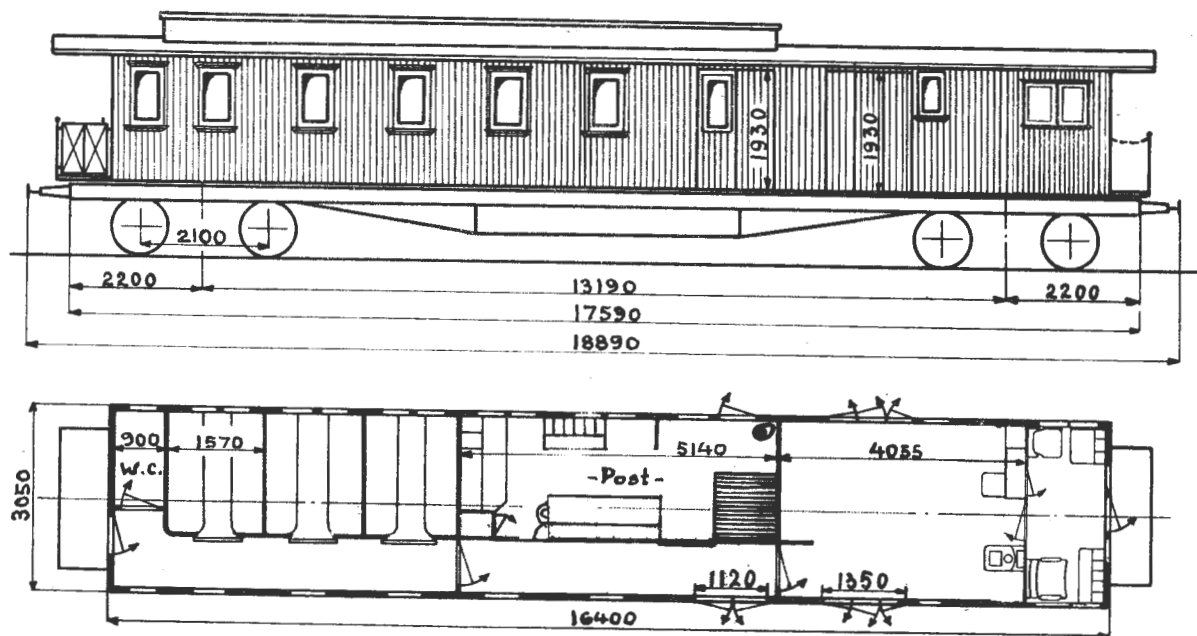
Oppr. hovedt. 625¹⁾

Vogn nr.	Distriktsmerke	Fabrikant	Byggeår	Omr. vognvekt i tonn	Sittepl. 2.klasse	Post, last i tonn	Reisegods, last i tonn	Grunnriss	El. varme i kW	Vognutstyr (se side 6)	Merknad
917	0	Skb	01	27,5	24	1,0	2,0			1H.3.5.8.11.39a	

1) Forandr. etter tegn. 6667

BDFo2-11

TYPE 3

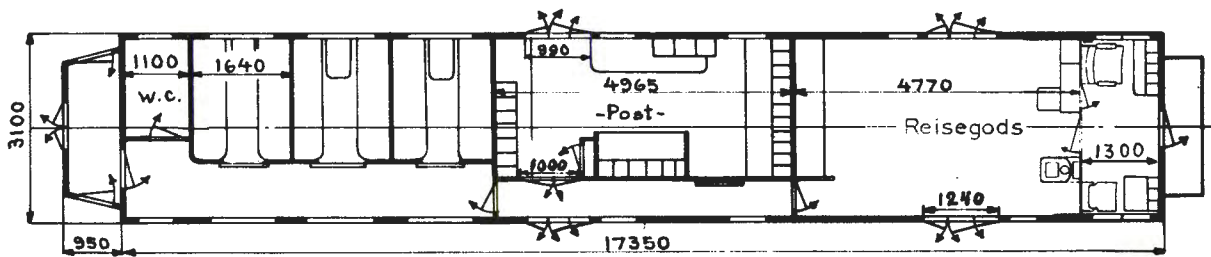
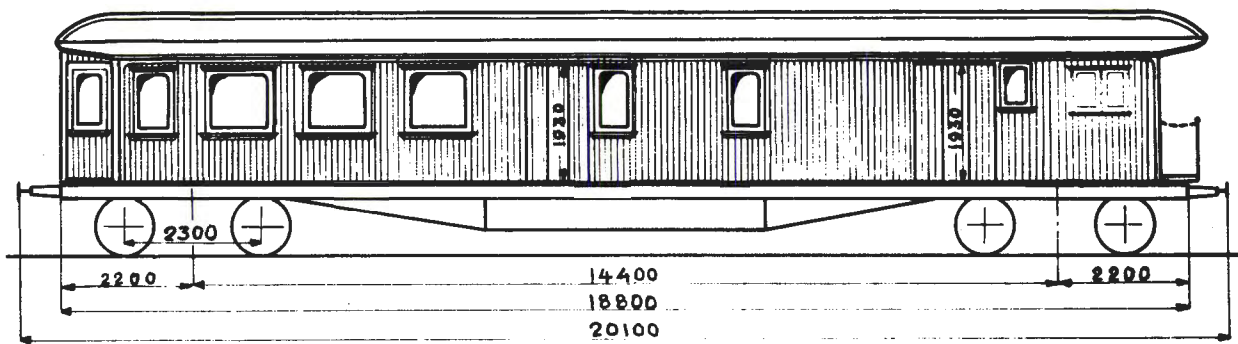

Hovedt. 1954
2442

Vogn nr.	Distriktsmerke	Fabrikant	Byggeår	Omr. vognvekt i tonn	Sittepl. 2.klasse	Post, last i tonn	Reisegods, last i tonn	Grunnriss	El.varme i kW	Vognutstyr (se side 6)	Merknad
620	D	SMv	21	32,5	24	1,5	3,5			1H.3.5.8.11.28.39a	1)
621	"	"	"	33,0	"	"	"			1H.3.5.8.11.28.39a	
18034	"	Skb	16	32,5	"	"	"			1H.3.5.8.11.28.39a	2) 3)
18085	"	SJv	20	33,0	"	"	"			1H.3.5.7.8.11.28.39a	
18086	"	"	"	31,5	"	"	"			1H.3.5.8.11.28.39a	
18109	T	Str	23	32,0	"	"	"			1H.3.5.8.11.39a	

- 1) Postrom forandr. e. sk. 1061
 2) " " " " 1194
 3) Hovedt. 1954
 Trykk nr. 751 1.7.58

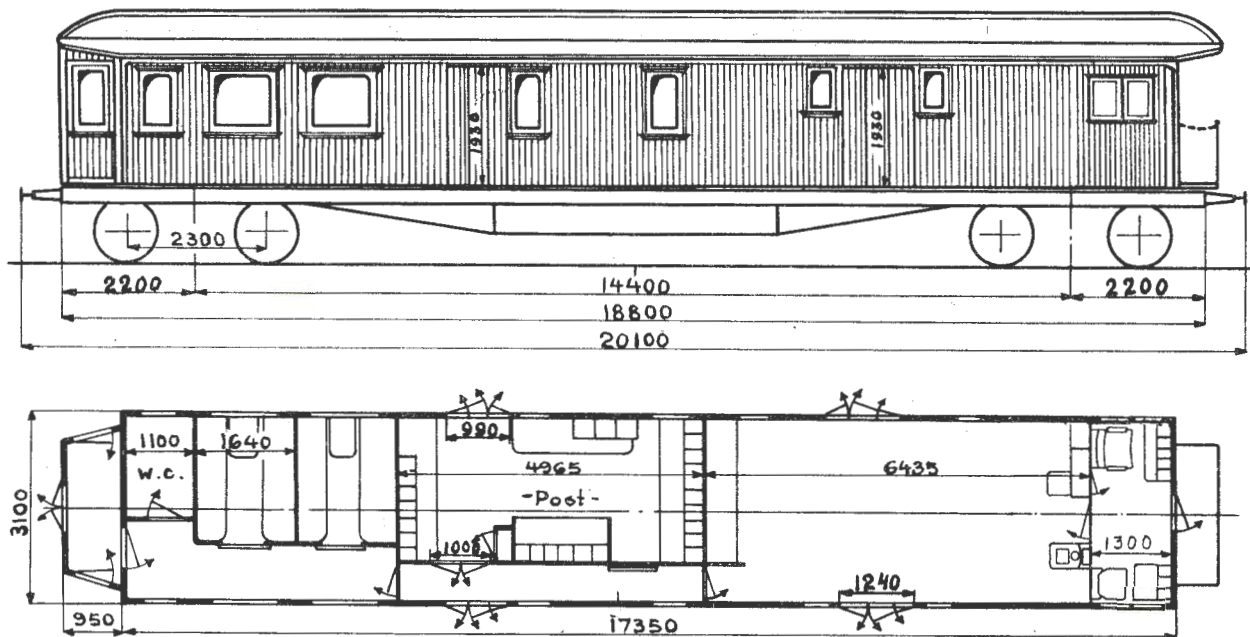

Hovedt. 2443

Vogn nr.	Distriktsmerke	Fabrikant	Byggeår	Omr. vognvekt i tonn	Sittepl. 2.klasse	Post, last i tonn	Reisegods, last i tonn	Grunnriss	El.varme i kW	Vognutstyr (se side 6)	Merknad
18091	T	SJv	20	32,5	16	1,5	4,5			1H.3.5.8.11.28.39a	

BDFo2-11

TYPE 5

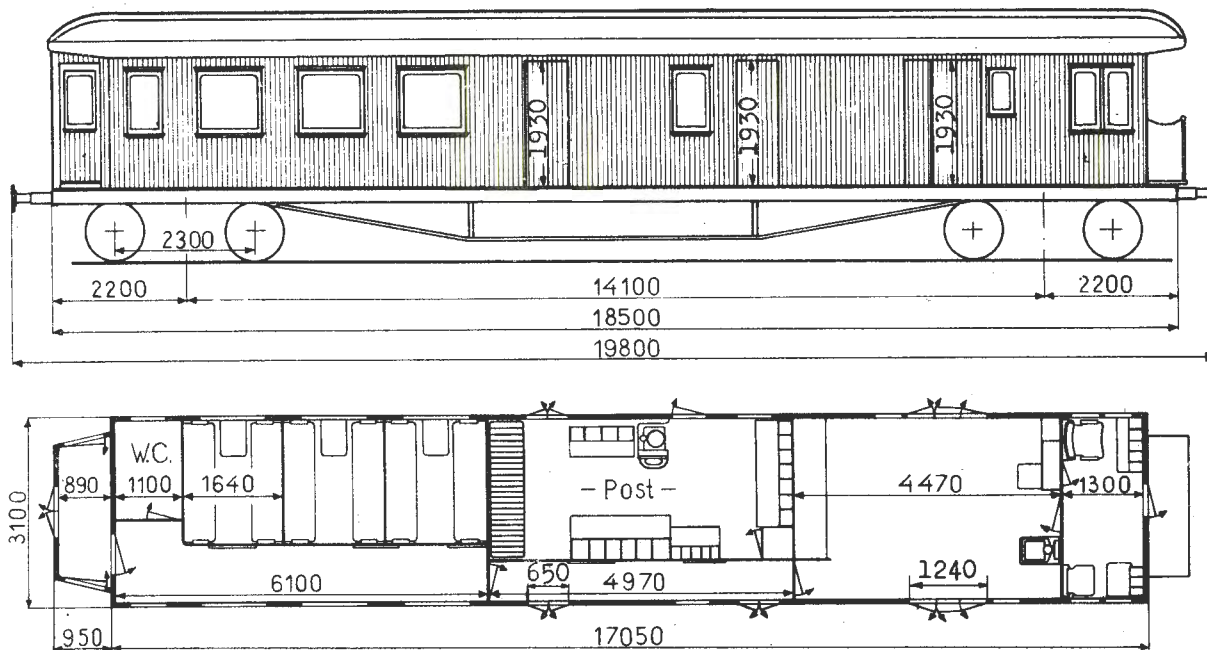

Oppr. hovedt. 1928¹⁾

Vogn nr.	Distriktsmerke	Fabrikant	Byggeår	Omr. vognvekt i tonn	Sittepl. 2.klasse	Post, last i tonn	Reisegods, last i tonn	Grunnriss	El. varme i kW	Vognutstyr (se side 6)	Merknad
775	H	SJv	21	32,5	24	2,0	2,0			1H.3.5.8.11.28.39a	

1) Forandr. etter tegn. 6880 og 6886

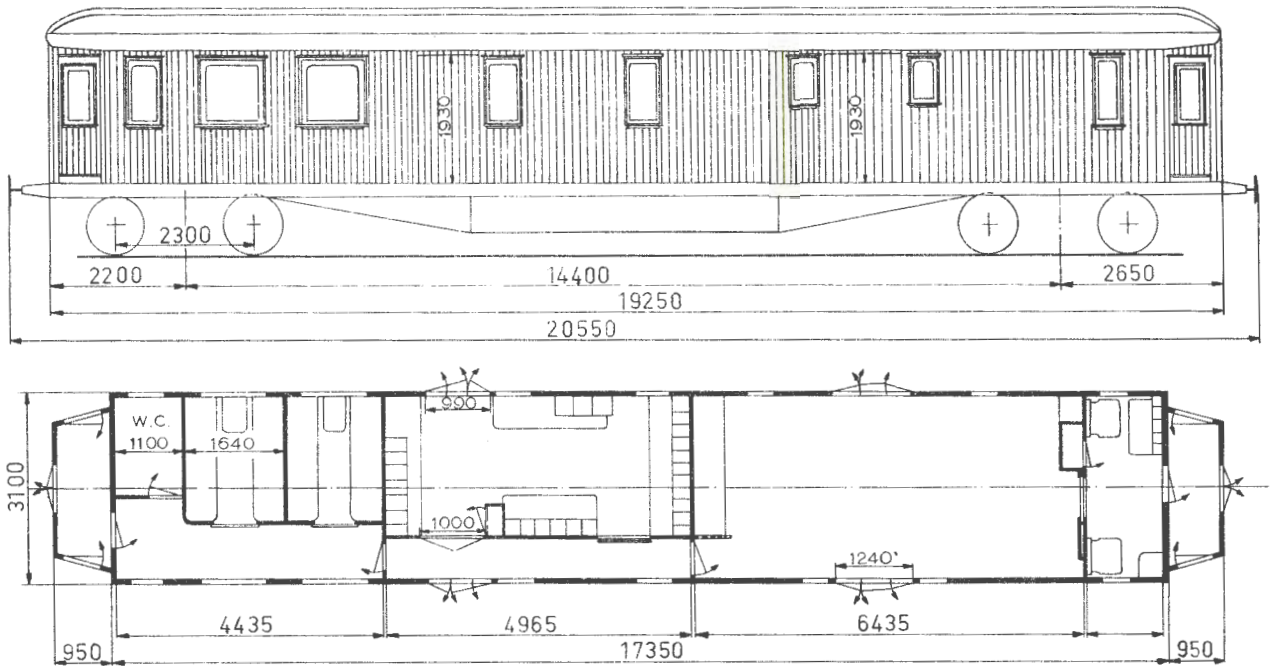

Hovedt. 2443

Vogn nr.	Distriktsmerke	Fabrikant	Byggeår	Omr. vognvekt i tonn	Sittepl. 2 klasse	Post, last i tonn	Reisegods, last i tonn	Grunnriss	EL.varme i kW	Vognutstyr (se side 6)	Merknad
18091	T	SJv	20	32,5	16	1,5	4,5			1H. 3. 5. 8. 11. 28 ¹⁾ . 39 a	

1) Bare i ende ved 2.kl.avd.

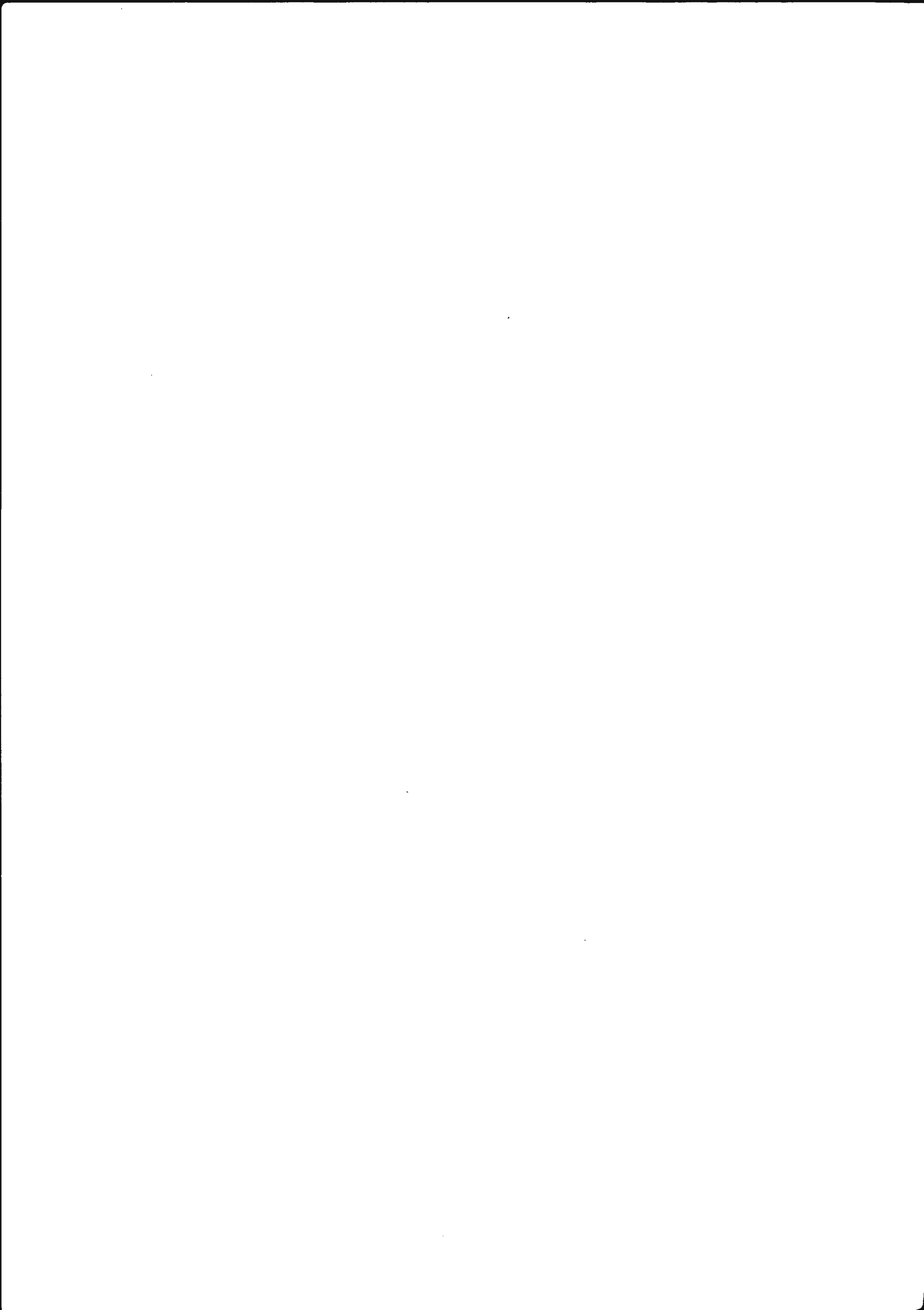

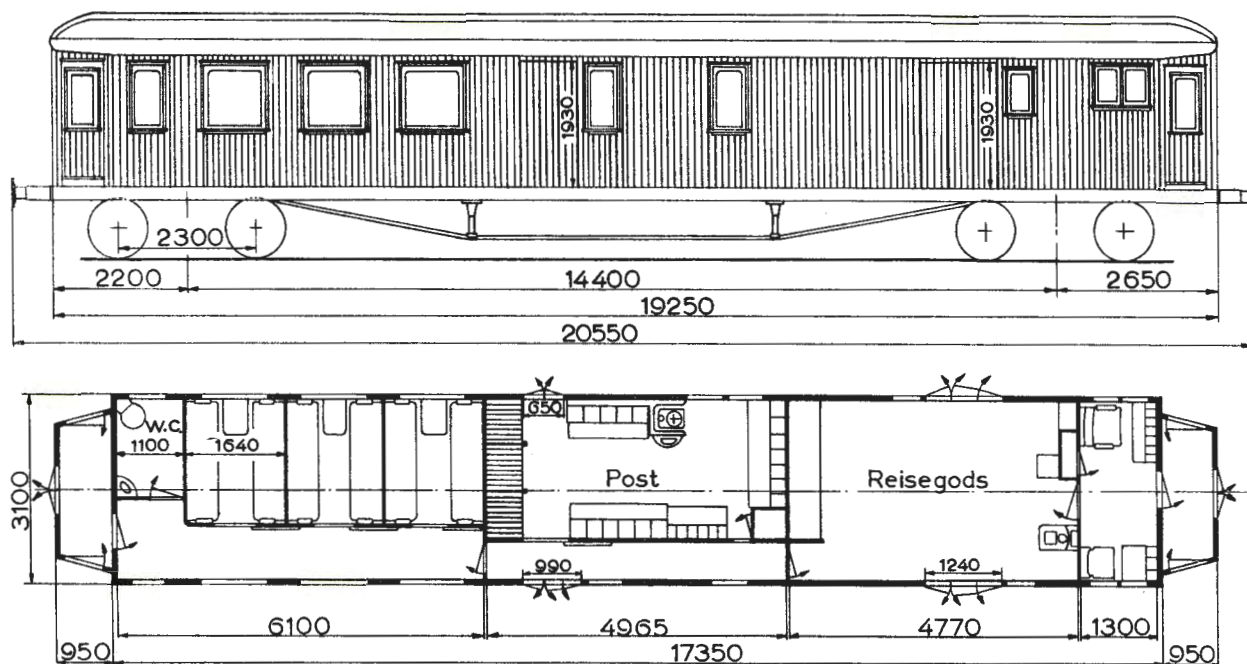
Oppr. hovedt. 1954¹⁾

Vogn nr.	Distriktsmerke	Fabrikant	Byggear	Omtr. vognvekt i tonn	Sittepl. 2.klasse	Post, last i tonn	Reisegods, last i tonn	Grunnriss	El.varme i kW	Vognutstyr (se side 6)	Merknad
18033	O	Skb	16	34,0	24	1,5	3,5			1H. 3. 5. 8. 11. 28 ²⁾ . 39a	

¹⁾ Postrom forandrt etter skisse 1194²⁾ Bare i ende ved 2.kl. avd.

BDFo2-11

TYPE 7

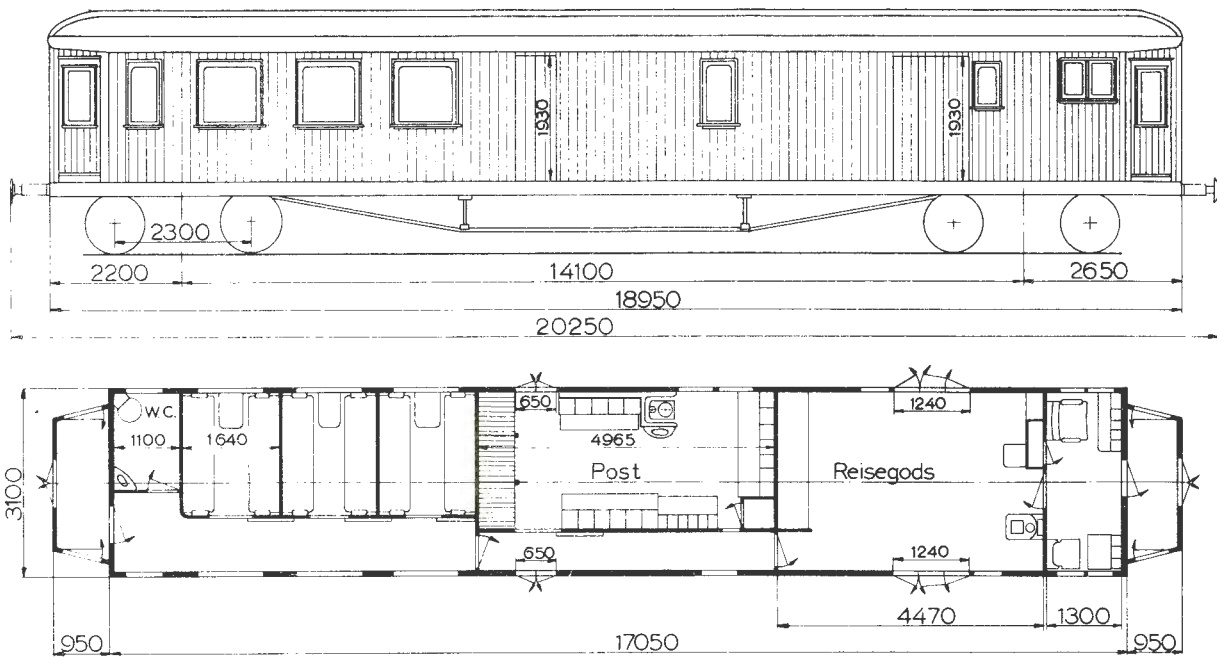

Oppr. hovedt. 1928^d

Vogn nr.	Distriktsmerke	Fabrikant	Byggeår	Omr. vognvekt i tonn	Sittepl. 2 klasse	Post, last i tonn	Reisegods, last i tonn	Grunnriss	El varme i kW	Vognutstyr (se side 6)	Merknad
881	O	Str.	17	33,5	24	1,5	3,5			1H. 3. 5. 8. 11. 28 ²⁾ 39a. 44	

^d Forandrt etter tegn. 7930

²⁾ Bare i ende ved 2.kl. avd.

Trykk nr. 751. 1.7. 57

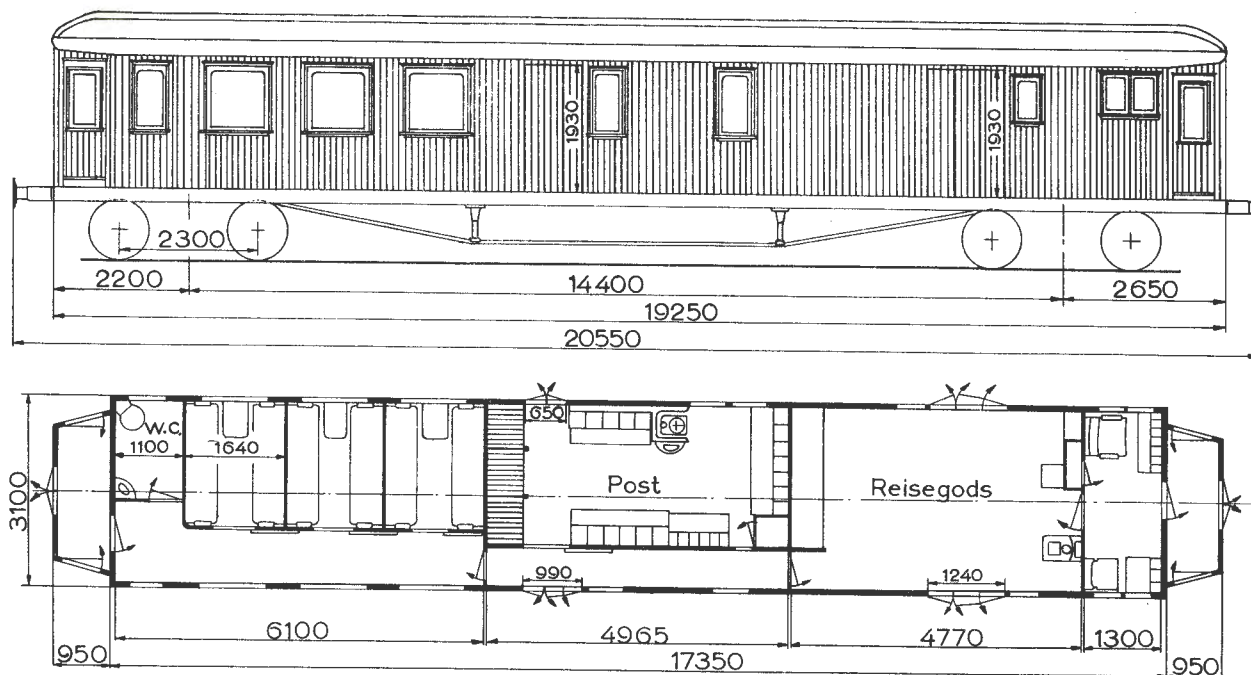

Oppr. hovedt. 1954¹⁾
 " " 2442³⁾

Vogn nr.	Distriktsmerke	Fabrikant	Byggeår	Omtr. vognvekt i tonn	Sittepl. 2.klasse	Post, last i tonn	Reise gods, last i tonn	Grunnriss	El.varme i kW	Vognutstyr (se side 6)	Merknad
18033	O	Skb	16	34,0	24	1,5	3,5			1H. 3. 5. 8. 11. 28 ²⁾ 39a	
18090	T	SJv	20	33,0	"	"	"			1H. 3. 5. 8. 11. 28 ²⁾ 39a	

1) Postrom forandr etter skisse 1194

2) Bare i ende ved 2.kl.avd.

3) Postrom forandr etter skisse 1025

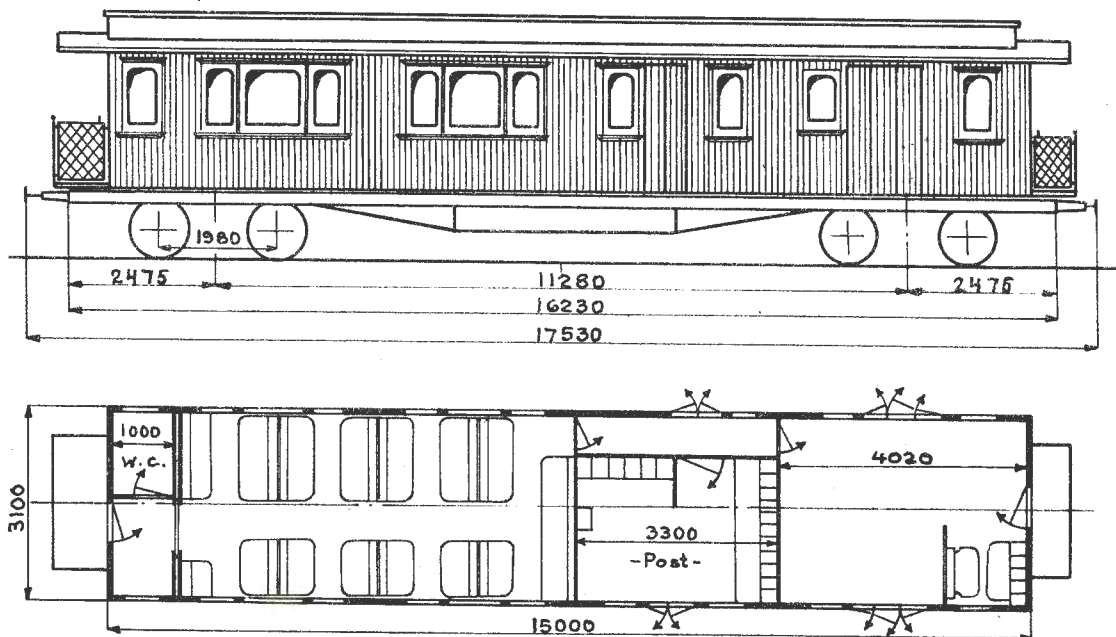

Oppr. hovedt. 91

Vogn nr.	Distriktsmerke	Fabrikant	Byggeår	Omtr. vognvekt i tonn	Sittepl. 2.klasse	Post, last i tonn	Reisegods, last i tonn	Grunniss	El. varme i kW	Vognutstyr (se side 6)	Merknad
326	0	Str	93	26,5	39	1,2	1,8			1H.3.5.8.10.39a	

BDFo3-7

TYPE 2

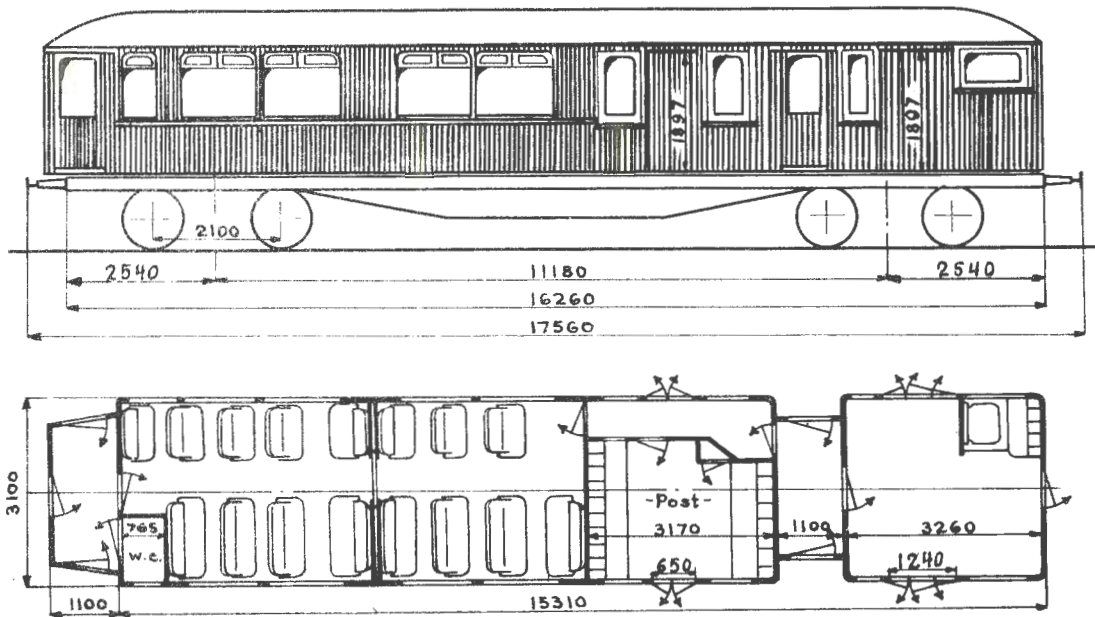

Oppr. hovedt. B. 65¹⁾

Vogn n.:	Distriktsmerke	Fabrikant	Byggeår	Omtr. vognvekt i tonn	Sittepl. 2.klasse	Post, last i tonn	Reisegods, last i tonn	Grunnriss	El. varme i kW	Vognutstyr (se side 6)	Merknad
70	T	Str	99	24,0	40	1,0	1,5			1H.3.5.11.41	Tilhenger for motorvogn

1) Ny vognkasse etter tegn. 3433

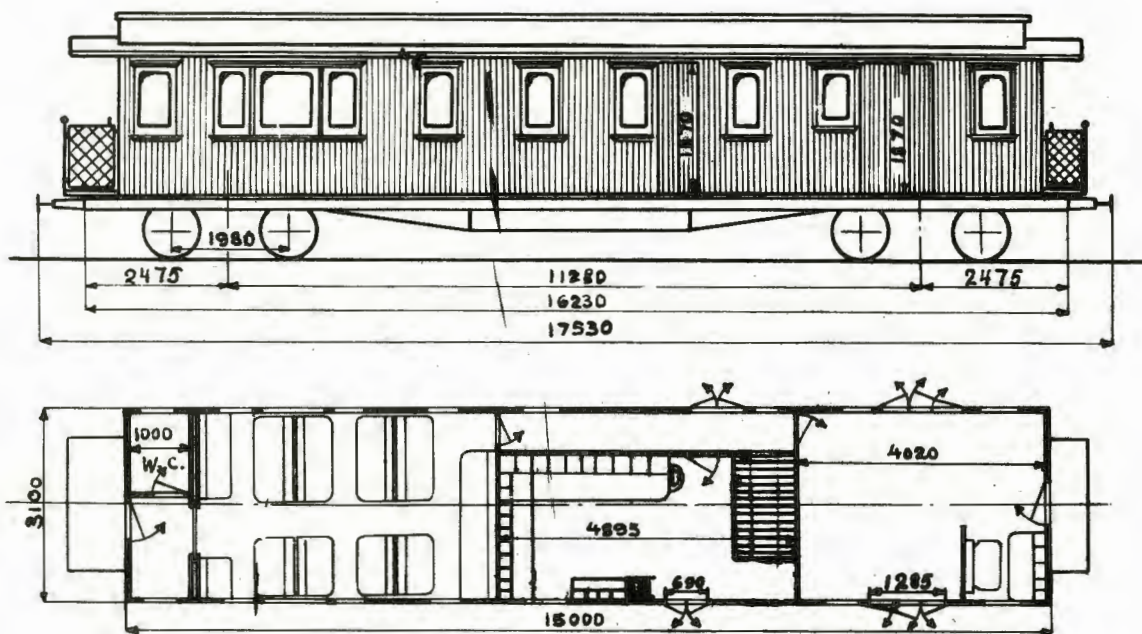

Oppr. hovedt. 139

Vogn nr.	Distriktsmerke	Fabrikant	Byggeår	Omt. vognvekt i tonn	Sittepl. 2.klasse	Post, last i tonn	Reisegods, last i tonn	Grunnriss	El.varme i kW	Vognutstyr (se side 6)	Merknad
295	0	Skb	90	26,0	28					1H.3.5.8.10	

BDFo3 - 16

TYPE 1

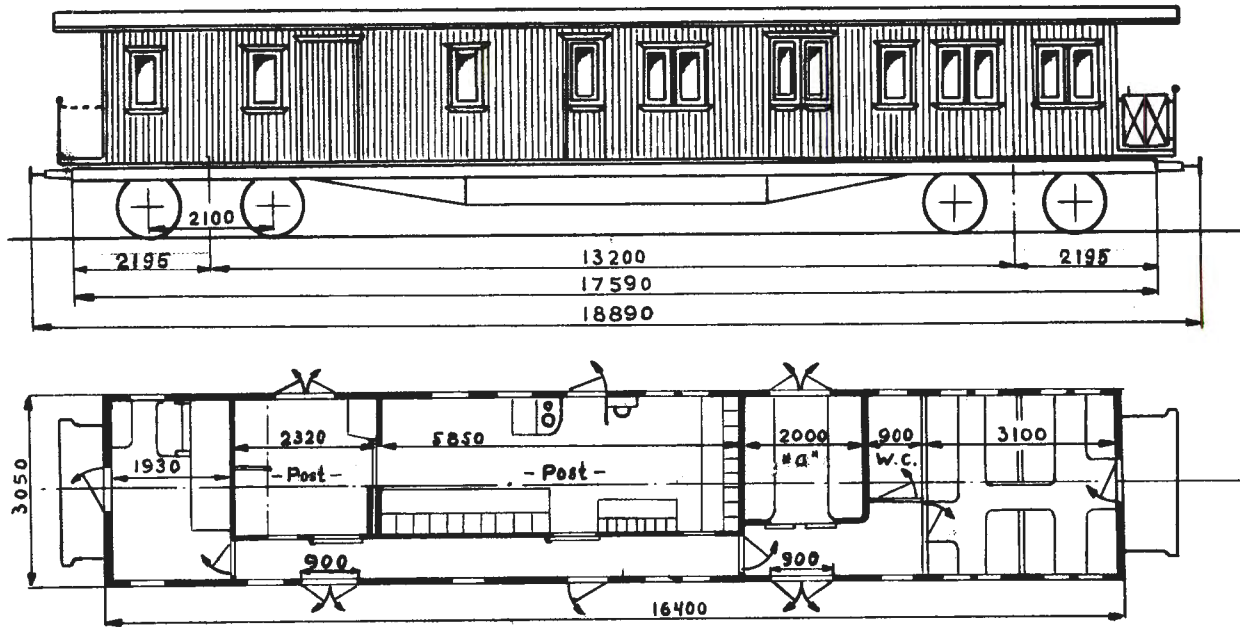

Oppr. hovedt. Valdresbanens nr. 2¹⁾

Vogn nr.	Distriktsmerke	Fabrikant	Byggeår	Omr. vognvekt i tonn	Sittepl. 2.klasse	Post, last i tonn	Reisegods, last i tonn	Grunnriss	El.varme i kW	Vognutstyr (se side 6)	Merknad
238	0	Skb	02	26,0	26	2,0	1,0			1H.3.5.7.8.11	} Sykekupé "a"
239	"	"	"	26,5	"	"	"			1H.3.5.8.11	

1) Forandr. etter tegn. 5487

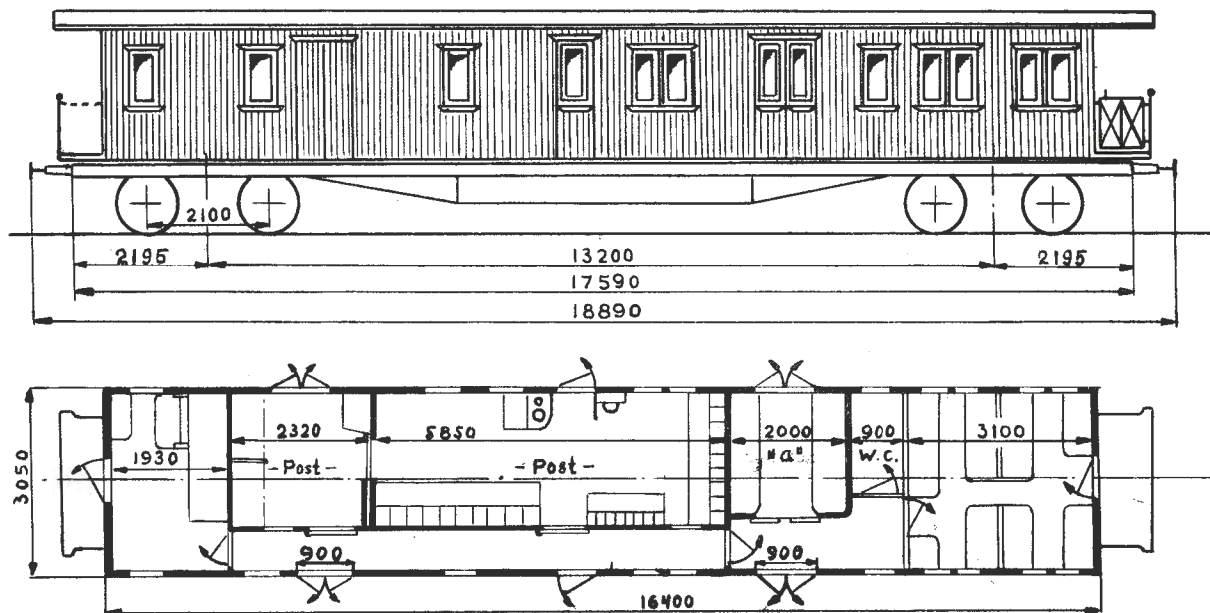

Oppr. hovedt. Valdresbanens nr. 2¹⁾

Vogn nr.	Distriktsmerke	Fabrikant	Byggeår	Omr. vognvekt i tonn	Sittepl. 2.klasse	Post, last i tonn	Reisegods, last i tonn	Grunnriss	El. varme i kW	Vognutstyr (se side 6)	Merknad
238	0	Skb	02	26,0	26	2,0	1,0			1H.3.5.7.8.11	} Sykekupé "a"
239	"	"	"	26,5	"	"	"			1H.3.5.7.8.11	

1) Forandr. etter tegn. 5487

BDFo3 - 11

TYPE 1

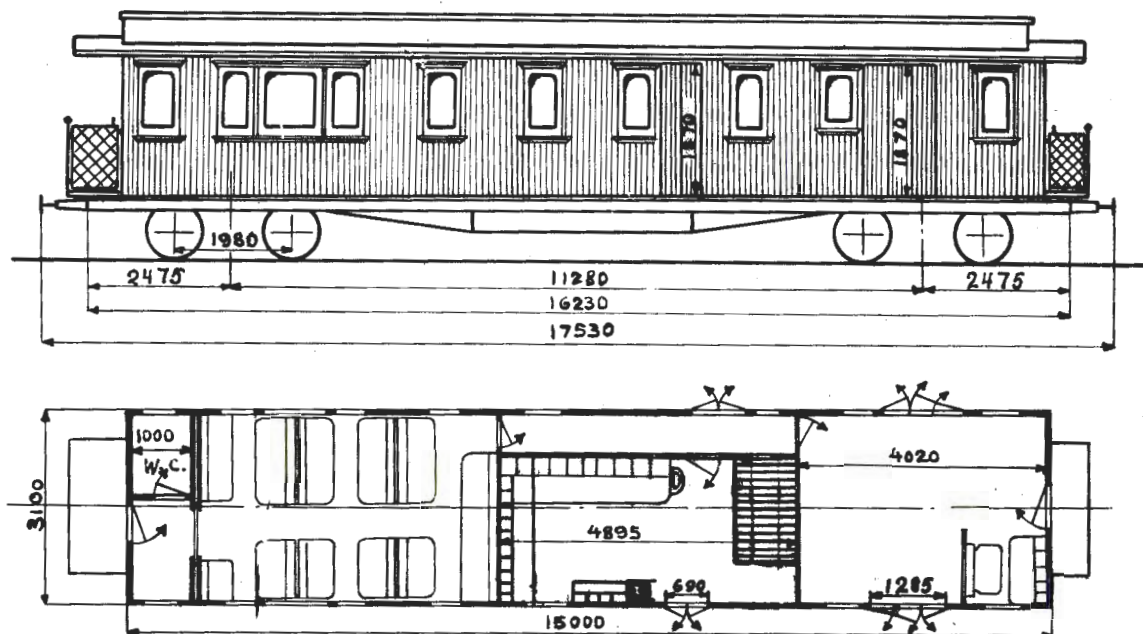

Oppr. hovedt. 139

Vogn nr.	Distriktsmerke	Fabrikant	Byggeår	Omtr. vognvekt i tonn	Sittepl. 2.klasse	Post, last i tonn	Reisegods, last i tonn	Grunnriss	El. varme i kW	Vognutstyr (se side 6)	Merknad
295	0	Skb	90	26,0	28					1H.3.5.8.10	

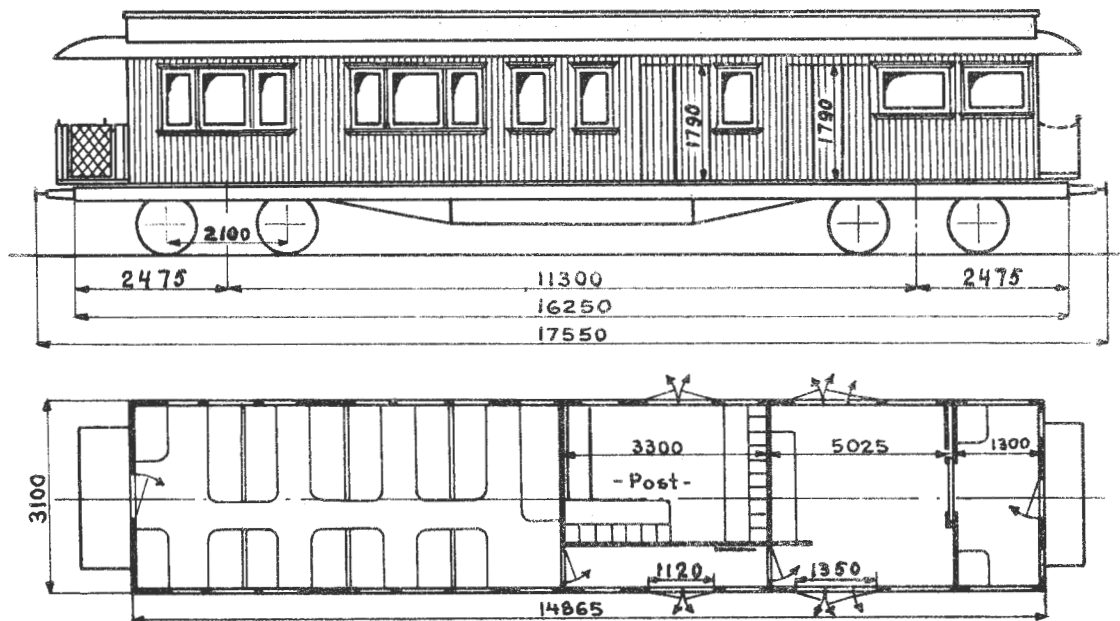

Hovedt. B. 301

Vogn nr.	Distriktsmerke	Fabrikant	Byggeår	Omtr. vognvekt i tonn	Sittepl. 2.klasse	Post, last i tonn	Reisegods, last i tonn	Grunnriss	El. varme i kW	Vognutstyr (se side 6)	Merknad
71	0	Skb	90	28,5	38	1,5	3,0			1H.3.5.8.10.39a	
72	=	=	=	29,0	=	=	=			1H.3.5.8.11.39a	

BDFo4-7

TYPE 2

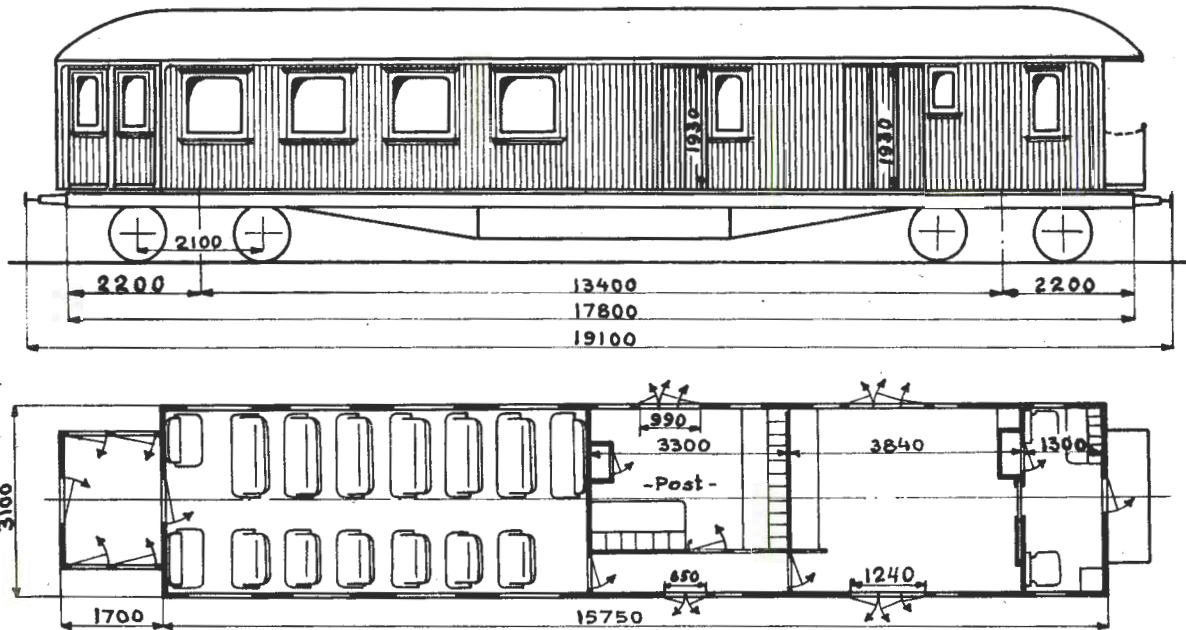

Hovedt. 2593

Vogn n.:	Distriktsmerke	Fabrikant	Byggeår	Omr. vognvekt i tonn	Sittepl. 2.klasse	Post, last i tonn	Reisegods, last i tonn	Grunnriss	El. varme i kW	Vognutstyr (se side 6)	Merknad
18108	B	Str	23	29,0	37	1,5	3,5			1H.3.5.11.28.39a	

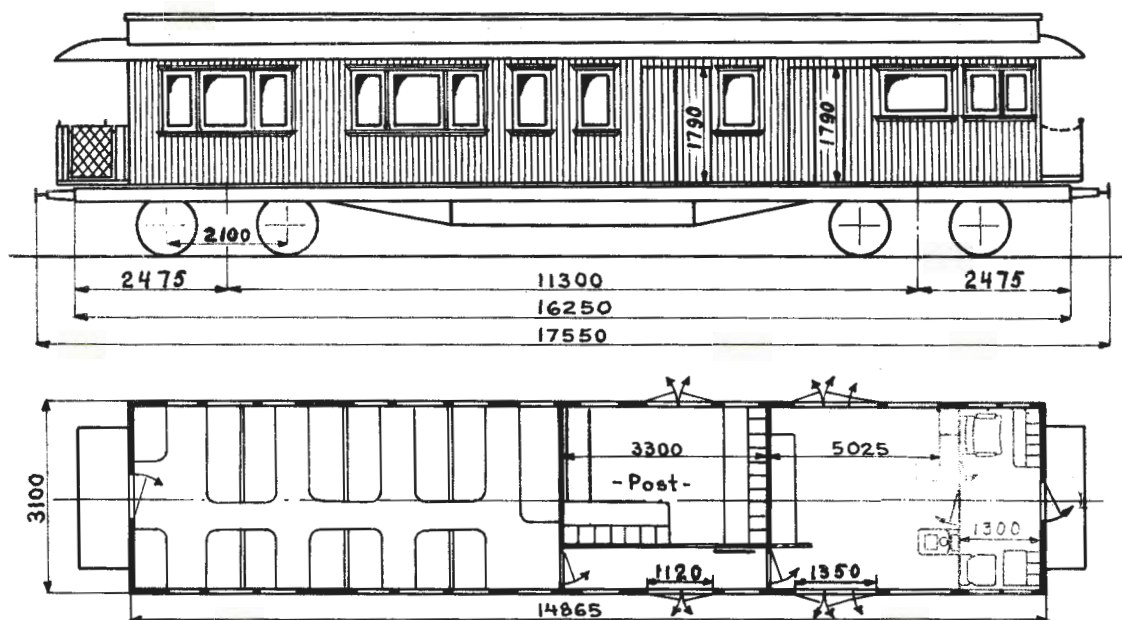

Hovedt. B. 301

Vogn nr.	Distriktsmerke	Fabrikant	Byggeår	Omr. vognvekt i tonn	Sittepl. 2.klasse	Post, last i tonn	Reisegods, last i tonn	Grunnriss	El.varme i kW	Vognutstyr (se side 6)	Merknad
71	0	Skb	90	28,5	38	1,5	3,0			1H.3.5.8.11.39a	
72	=	"	"	30,0	"	"	"			1H.3.5.8.11.39a	

BDFo4-7

TYPE 2

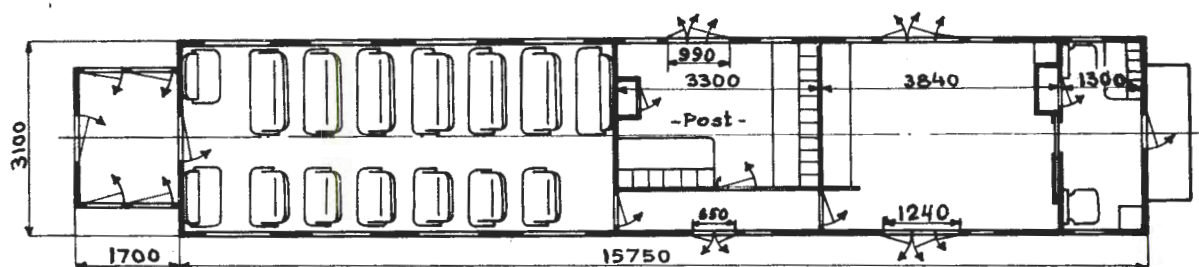
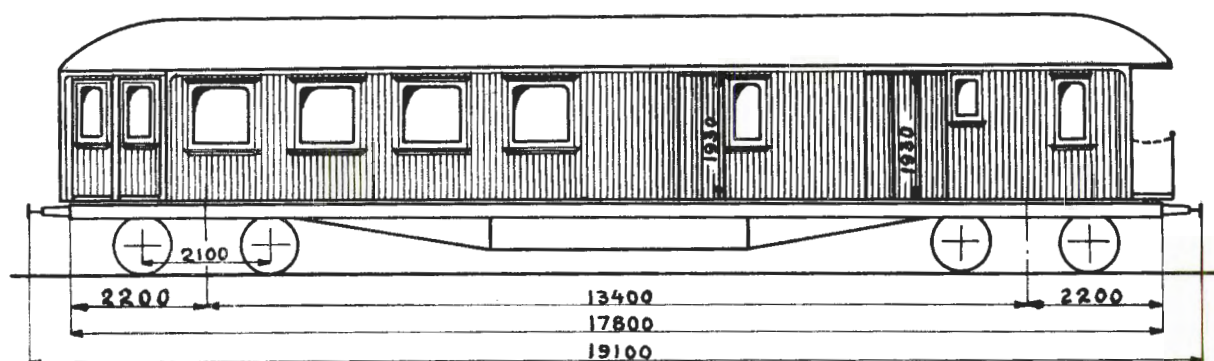

Postrum: 7,4 m²

Hovedt. 2593

Vogn nr.	Distriktsmerke	Fabrikant	Byggeår	Omr. vognvekt i tonn	Sittepl. 2.klasse	Post, last i tonn	Reisegods, last i tonn	Grunnriss	El. varme i kW	Vognutstyr (se side 6)	Merknad
18108	B	Str	23	29,0	37	1,5	3,5			1H.3.5.8.11.28.39a	

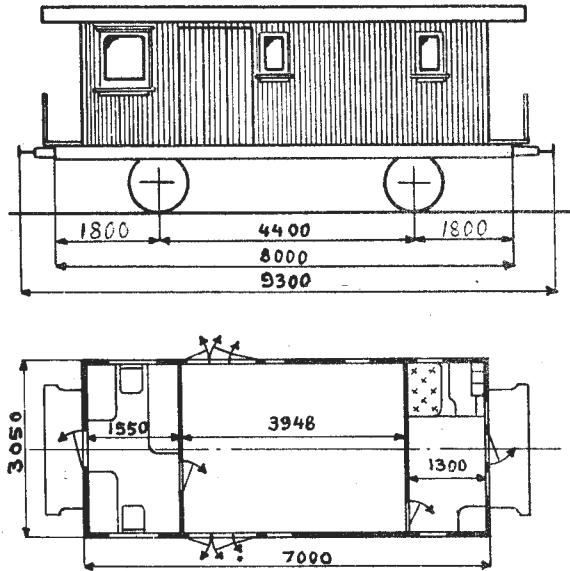

Oppr. hovedt. 478

Vogn nr.	Distriktsmerke	Fabrikant	Byggeår	Omr. vognvekt i tonn	Sittepl. 2.klasse	Reisegods, last i tonn	Grunnriss	El.varme i kW	Vognutstyr (se side 6)	Merknad
9001	0	Str	04	10,5	7				1H.3.6.8.13.24	

BF2a

TYPE 1

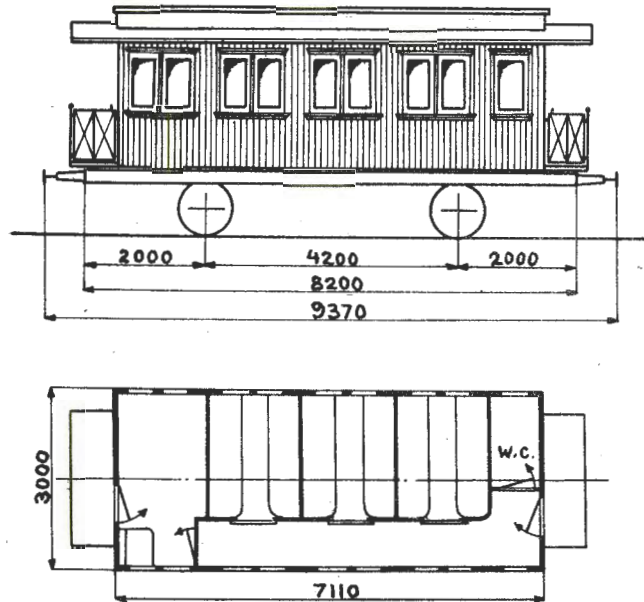

Oppr. hovedt. 0.d. tegn. 425

Vogn nr.	Distriktsmerke	Fabrikant	Byggeår	Omtr. vognvekt i tonn	Sittepl. 2.klasse	Reisegods, last i tonn	Grunnriss	El. varme i kW	Vognutstyr (se side 6)	Merknad
145	0	Str	98	11,0	24	0,5			3.5.7.8.13.15	
151	"	"	"	"	"	"			3.5.7.8.13.15	

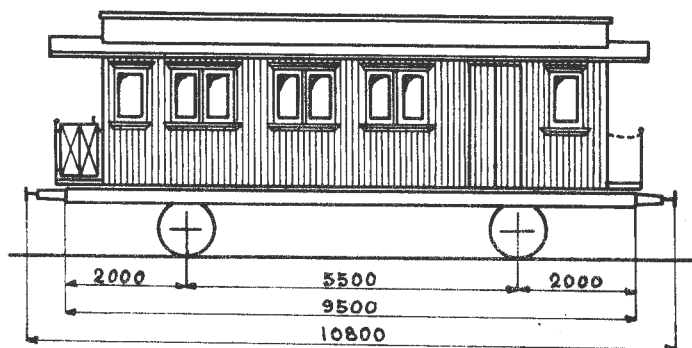

Grunnriss 1

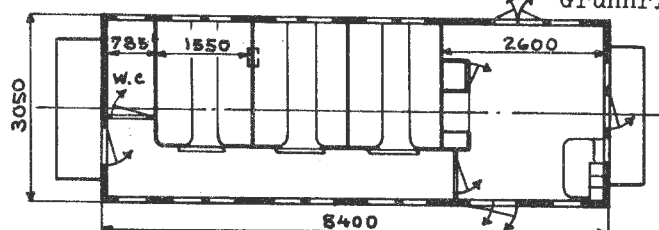

Oppr. hovedt. 760

Grunnriss 2

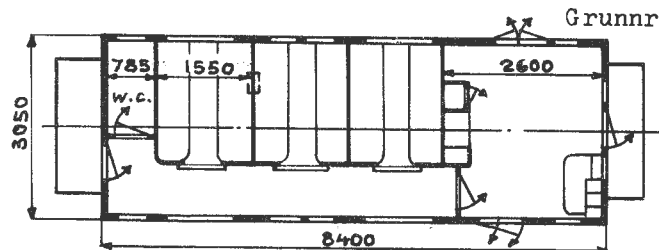

Oppr. hovedt. 948

Vogn nr.	Distriktsmerke	Fabrikant	Byggeår	Omr. vognvekt i tonn	Sittepl. 2.klasse	Reisegods, last i tonn	Grunnriss	El. varme i kW	Vognutstyr (se side 6)	Merknad
685	0	Skb	05	13,5	24	0,5	1		3.6.7.8.10.15.24	
686	"	"	"	14,0	"	"	"		3.6.7.8.10.15.24	
687	T	"	"	12,5	"	"	"		3.6.7.8.11.15.24	
689	0	"	08	14,0	"	"	2		3.6.7.8.10.15.24	

BF2b

TYPE 1

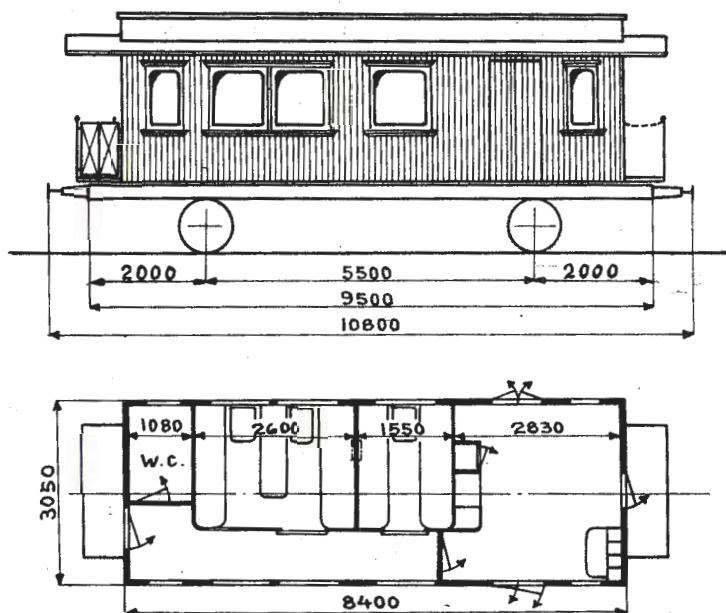

Oppr. hovedt. 1245

Vogn nr.	Distriktsmerke	Fabrikant	Byggeår	Omtr. vognvekt i tonn	Sittepl. 2.klasse	Reisegods, last i tonn	Grunnriss	El.varme i kW	Vognutstyr (se side 6)	Merknad
691	N	Skb	11	12,5	19	0,5			1W.3.6.7.8.13.24.40	
693	'	"	12	"	"	"			1W.3.6.7.8.13.24.40	
695	T	"	13	13,5	"	"			3.6.7.8.11.15.24	
679	N	Str	25	"	"	"			1W.3.6.7.8.10.24.40	

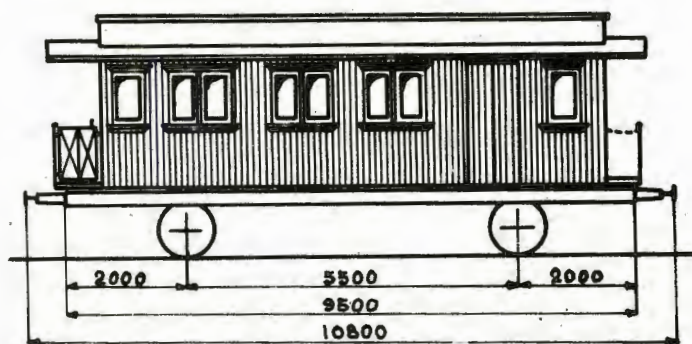

Grunnriss 1

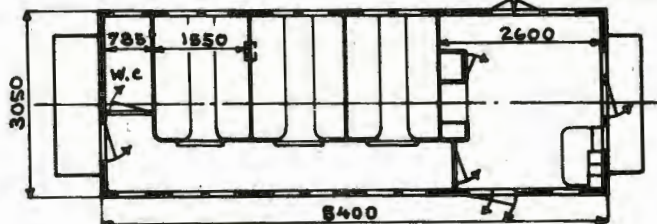

Oppr. hovedt. 760

Grunnriss 2

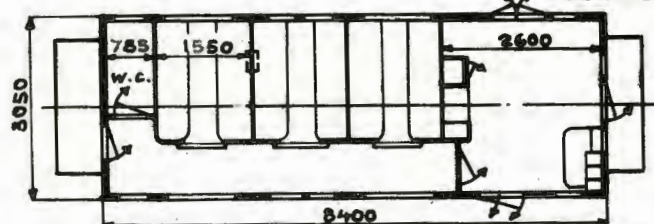

Oppr. hovedt. 948

Vogn nr.	Distriktsmerke	Fabrikant	Byggeår	Omtr. vognvekt i tonn	Sittepl. 2.klasse	Reisegods, last i tonn	Grunnriss	El-varme i kW	Vognutstyr (se side 6)	Merknad
685	0	Skb	05	13,5	24	0,5	1		3.6.7.8.10.15.24	
686	"	"	"	14,0	"	"	"		3.6.7.8.10.15.24	
687	T	"	"	12,5	"	"	"		3.6.7.8.11.15.24	
689	0	"	08	14,0	"	"	2		3.6.7.8.10.15.24	

BF2b

TYPE 1

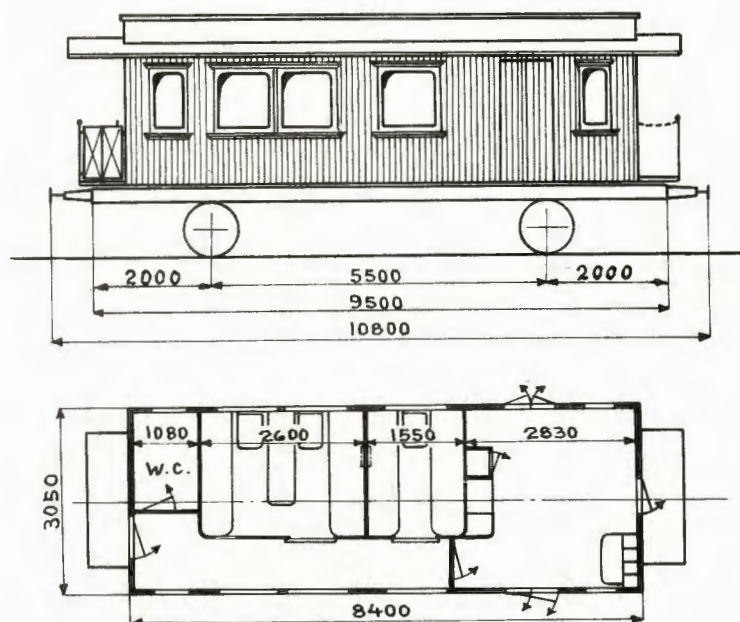

2
Oppr. hovedt. 1245

Vogn nr.	Distriktsmerke	Fabrikant	Byggeår	Omr. vognvekt i tonn	Sittepl. 2.klasse	Reisegods, last i tonn	Grunnriss	El. varme i kW	Vognutstyr (se side 6)	Merknad
679	N	Str	25	13,5	19	0,5			1W.3.6.7.8.10.24.40	
691	"	Skb	11	12,5	"	"			1W.3.6.7.8.10.24.40	
693	"	"	12	"	"	"			1W.3.6.7.8.10.24.40	
695	T	"	13	13,5	"	"			3.6.7.8.11.15.24	

BF3
TYPE 1
Stålvogner

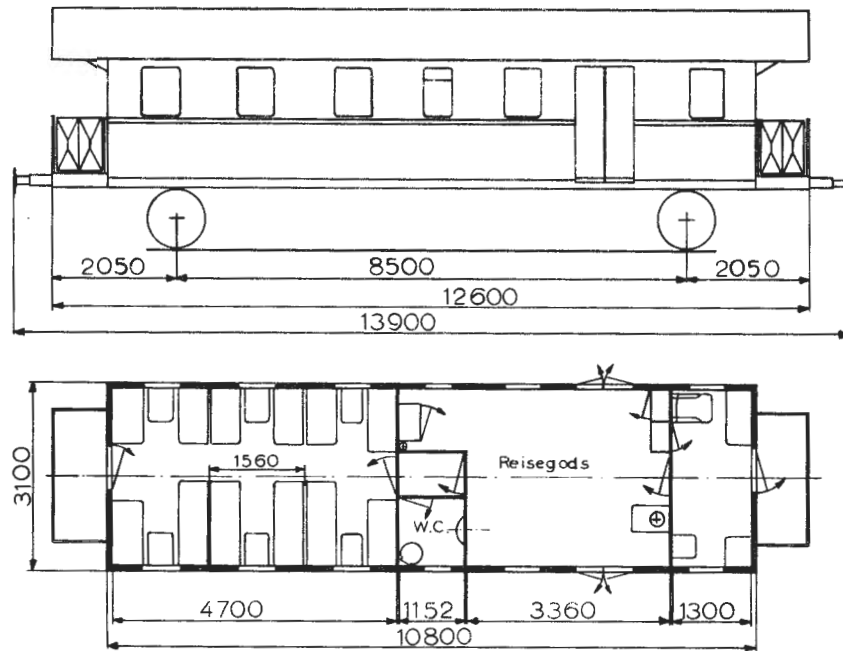

Hovedt. 7273

Vogn nr.	Distriktsmerke	Fabrikant	Byggeår	Omr. vognvekt i tonn	Sittepl. 2. klasse	Reisegods, last i tonn	Grunnriss	El.varme i kW	Vognutstyr (se side 6)	Merknad
19900	S		28	20,5	28	2,0			1H. 3. 5. 7. 8. 11. 24	
19902	T		"	19,5	"	"			1H. 3. 5. 7. 8. 11. 24	
19903	"		"	19,0	"	"			1H. 3. 5. 7. 8. 11. 24	
19904	H		"	"	"	"			1H. 3. 5. 7. 8. 11. 24	
19905	"		"	19,5	"	"			1H. 3. 5. 7. 8. 11. 24	
19906	O		"	19,0	"	"			1H. 3. 5. 7. 8. 11. 24	
19907	"		29	19,5	"	"			1H. 3. 5. 7. 8. 11. 24	
19908	"		"	"	"	"			1H. 3. 5. 7. 8. 11. 24	
19909	"		"	19,0	"	"			1H. 3. 5. 7. 8. 11. 24	
19911	D		"	19,5	"	"			1H. 3. 5. 7. 8. 11. 24	
19912	"		"	"	"	"			1H. 3. 5. 7. 8. 11. 24	

BF3

TYPE 2

Stålvogner

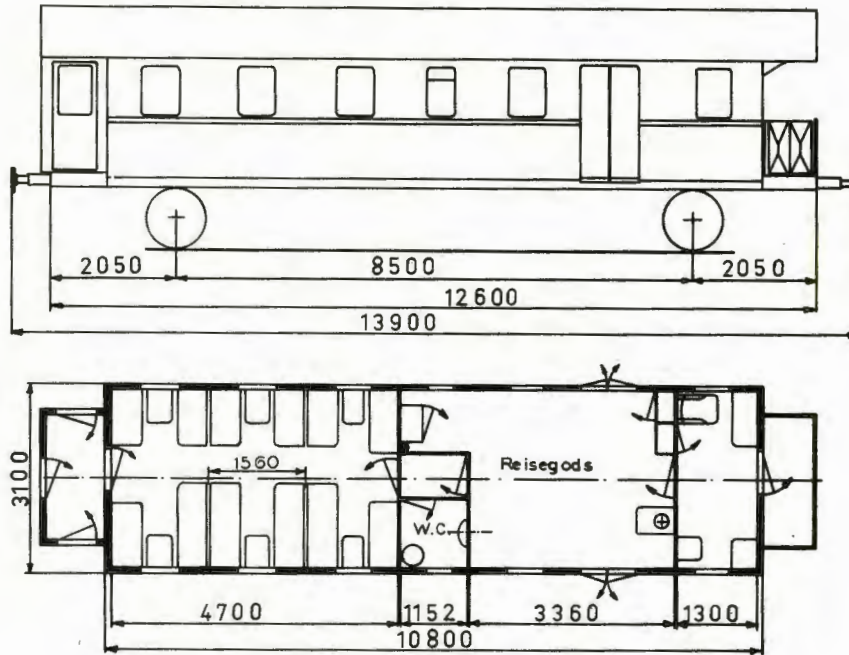

Hovedt. 7273

Vogn nr.	Distriktsmerke	Fabrikant	Byggeår	Omr. vognvekt i tonn	Sittepl. 2. klasse	Reise gods. last i tonn	Grunnriss	EL.varme i kw	Vognutstyr (se side 6)	Merknad
19901	S		28	19.5	28	2.0			1H. 3. 5. 7. 8. 11. 24	

Tilleggsblad til BF3 type 1

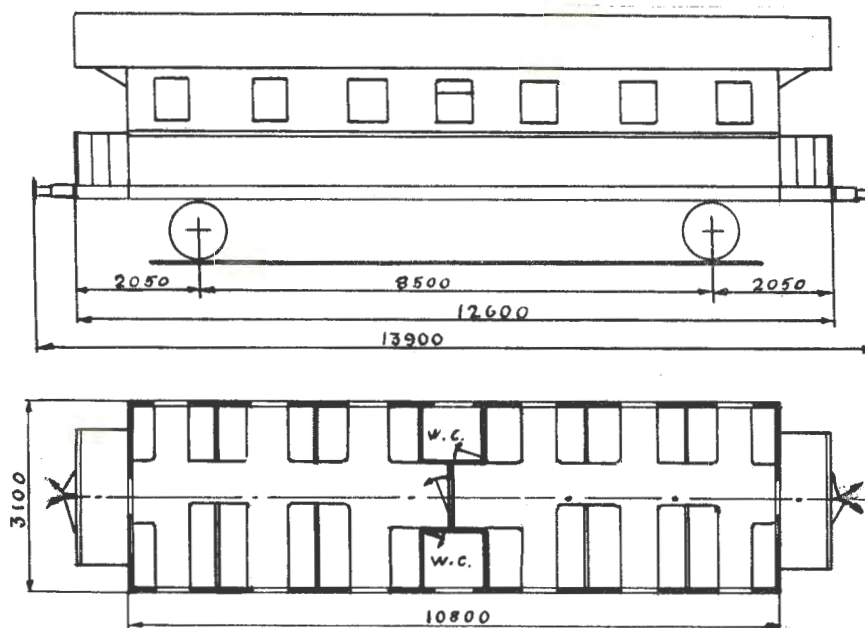

Hovedt. skisse 878

Vogn nr.	Distriktsmerke	Fabrikant	Byggeår	Omt. vognvekt i tonn	Sittepl. 2.klasse	Grunnriss	El. varme i kW	Vognutstyr (se side 6)	Merknad
19901								1KK.3	Disse vogner vil etterhvert bli ombygd slik at de får reiseGodsrom og 28 sitteplasser og vil da bli overført til typebladet (BF3-1) på foranstående blad.
19902								1KK.3	
19903								1KK.3	
19904								1KK.3	
19905								1KK.3	
19906								1KK.3	
19907								1KK.3	
19908								1KK.3	
19909								1KK.3	
19911								1KK.3	
19912								1KK.3	

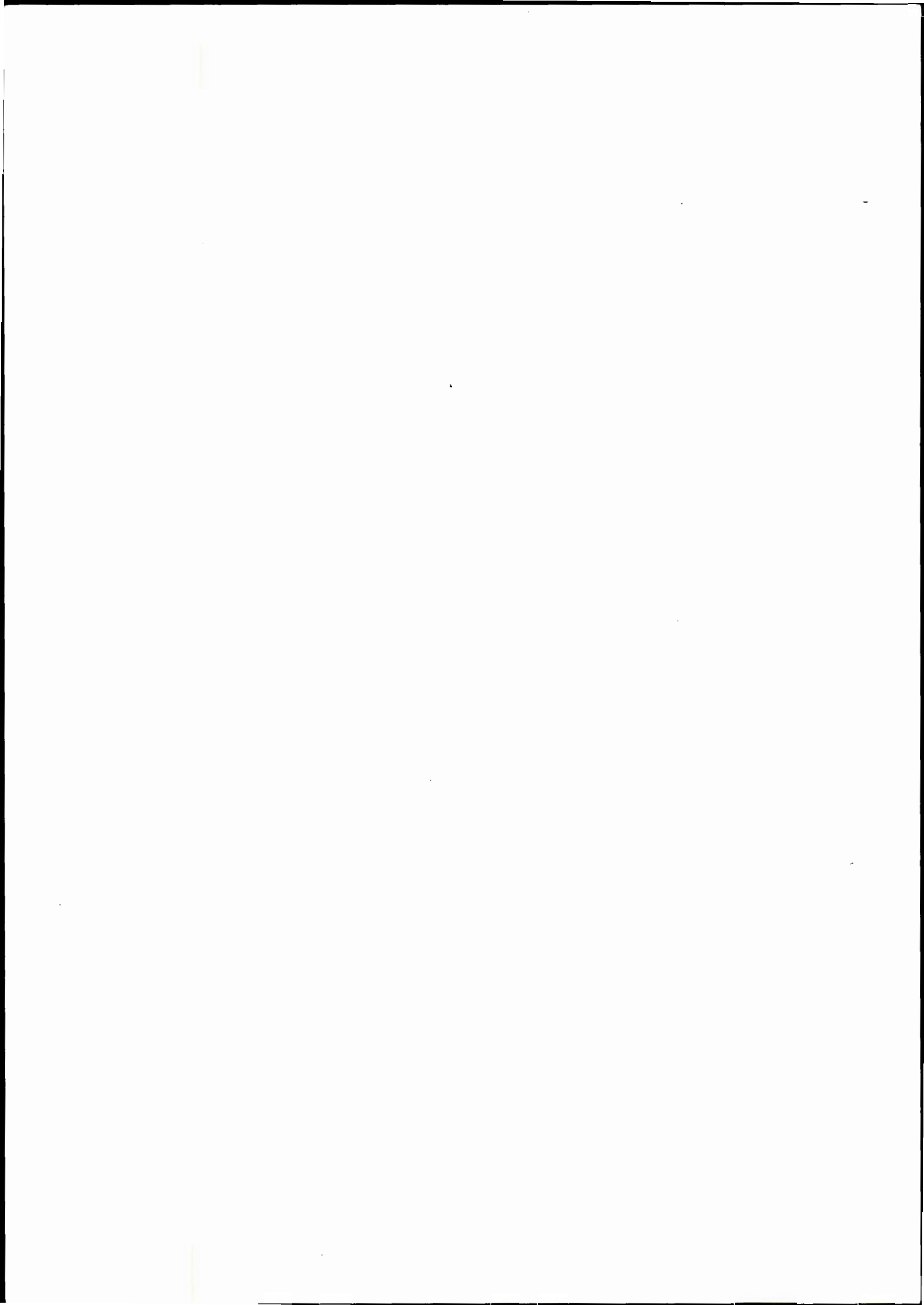

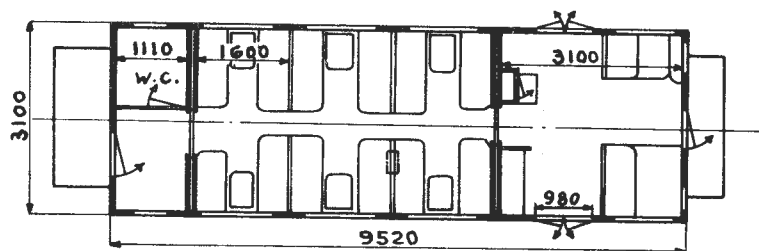
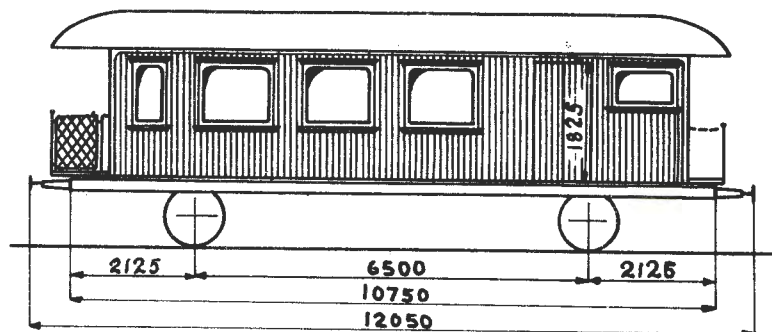

Hovedt. B. 368

Vogn n.:	Distriktsmerke	Fabrikant	Byggeår	Omtr. vognvekt i tonn	Sittepl. 2.klasse	Reisegods, last i tonn	Grunnriss	El. varme i kW	Vognutstyr (se side 6)	Merknad
1001	0	Str	15	15,0	24	0,5			1H.3.6.7.8.13.24	
1002	D	SMv	21	16,0	"	"			1H.3.6.7.8.11.24	

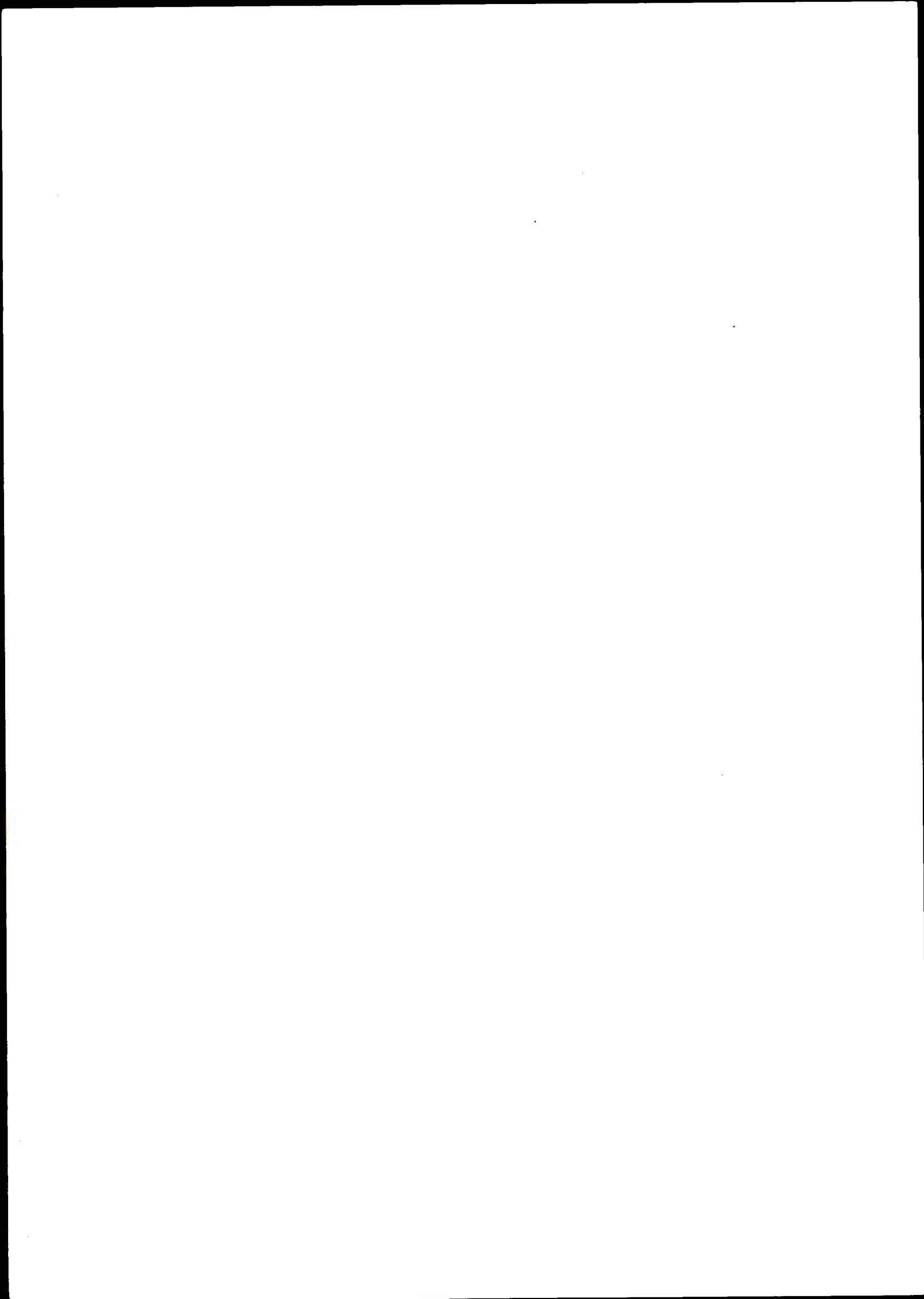

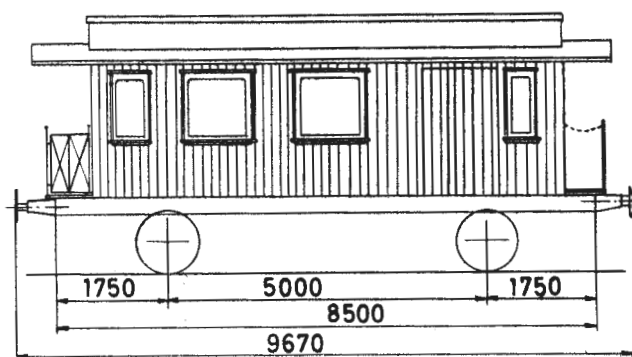

Grunnriss 1

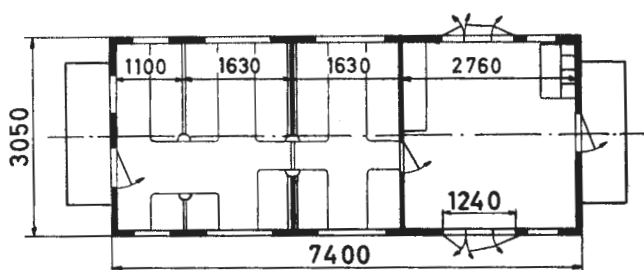

Grunnriss 2¹⁾

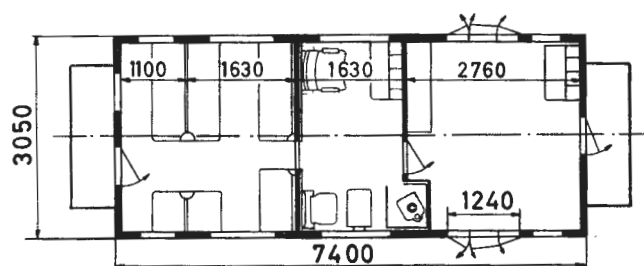

Hovedt. 1209

Vogn nr.	Distriktsmerke	Fabrikant	Byggeår	Omr. vognvekt i tonn	Sittepl. 2.klasse	Reisegods, last i tonn	Grunnriss	El.varme i kW	Vognutstyr (se side 6)	Merknad
546	D	Str	12	11,5	23	1,0	1		1H. 3. 6. 7. 8. 11. 24	
547	"	"	"	"	13	"	2		1H. 3. 6. 7. 8. 11. 24	
548	"	"	"	11,0	23	"	1		1H. 3. 6. 7. 8. 11. 24	
549	K	"	"	11,5	13	"	2		1H. 3. 6. 7. 8. 11. 24	

BFo2a

TYPE 1

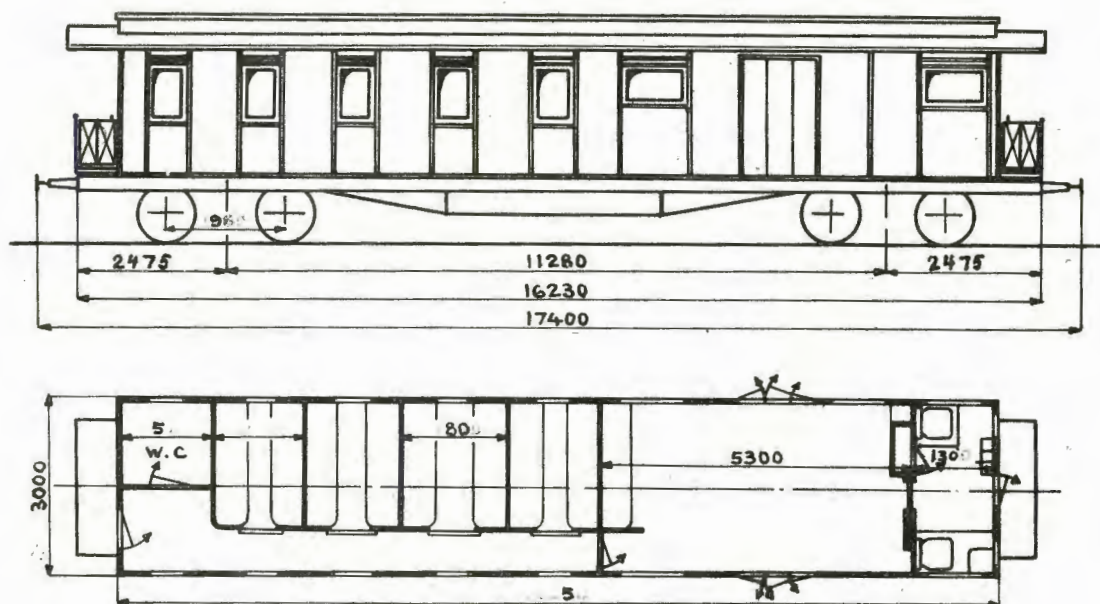

Oppr. hovedt. 205¹⁾
312a¹⁾

Vogn nr.	Distriktsmerke	Fabrikant	Byggear	Omtr. vognvekt i tonn	Sittepl. 2.klasse	Reisegods, last i tonn	Grunnriss	El. varme i kW	Vognutstyr (se side 6)	Merknad
732	H	Skb	93	25,5	32				3.5.7.13	

1) Forandr. etter Hmr d. tegn. H 3078-3
Trykk nr. 751 1.7.56

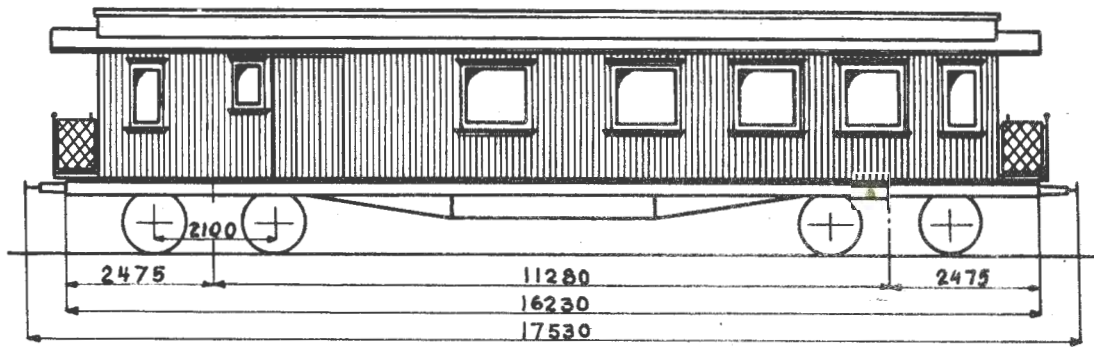

Grunnriss 1

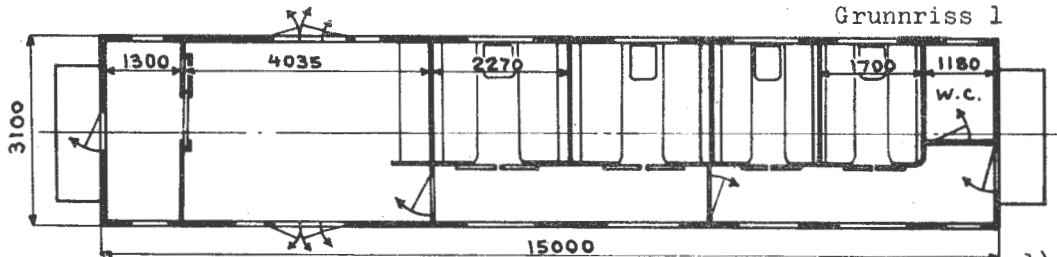

Oppr. hovedt. 7¹⁾

Grunnriss 2

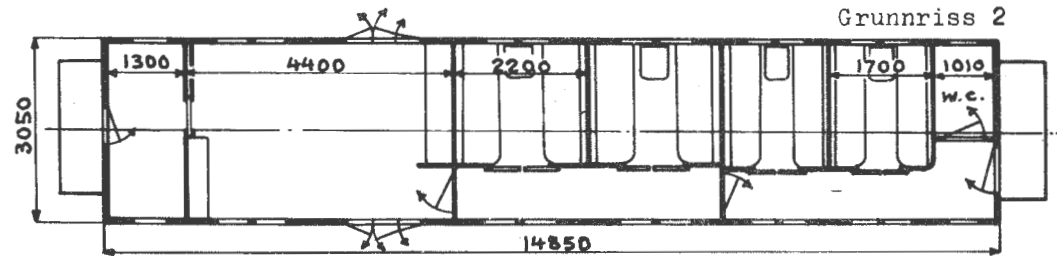

Oppr. hovedt. 207²⁾

Vogn n.	Distriktsmerke	Fabrikant	Byggear	Omr. vognvekt i tonn	Sittepl. 2.klasse	Reisegods, last i tonn	Grunnriss	El.varme i kW	Vognutstyr (se side 6)	Merknad
241	0	Skb	87	27,5	32	2,0	1		1H.3.5.7.8.11	Sykekupé
212	"	Atl	93	26,0	"	"	2		1H.3.5.8.11	

1) Forandr. etter O.d. tegn. 1154

2) " " " " 2221

BFo2a

TYPE 3

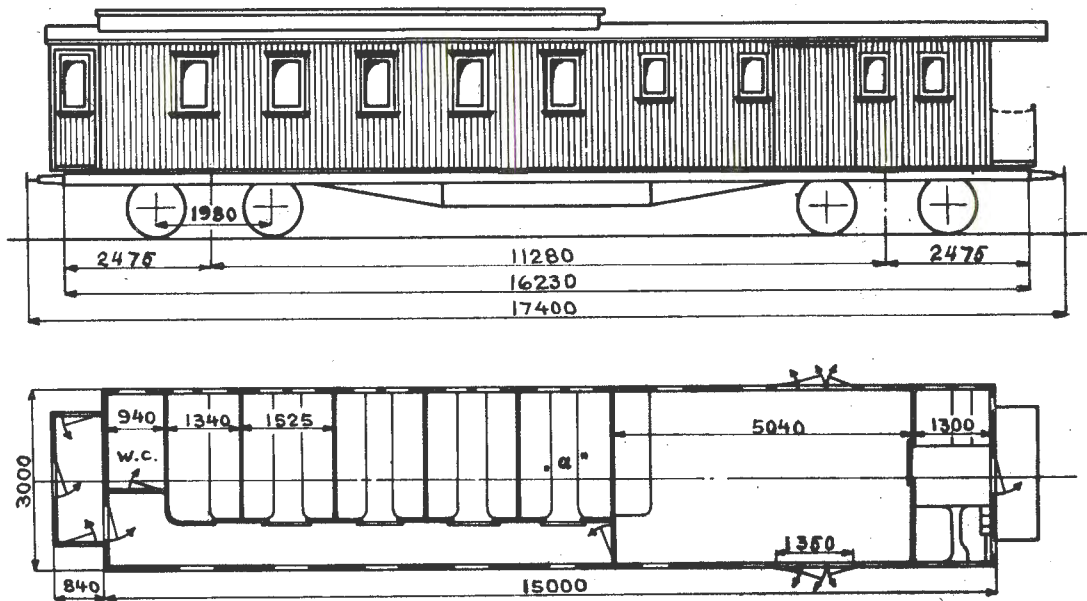

Oppr. hovedt. 369

Vogn nr.	Distriktsmerke	Fabrikant	Byggeår	Omtr. vognvekt i tonn	Sittepl. 2.klasse	Reisegods, last i tonn	Grunnriss	El.varme i kW	Vognutstyr (se side 6)	Merknad
805	H	Str	96	22,5	36				1H.3.5.7.8.13	Prov. postkupé "a"

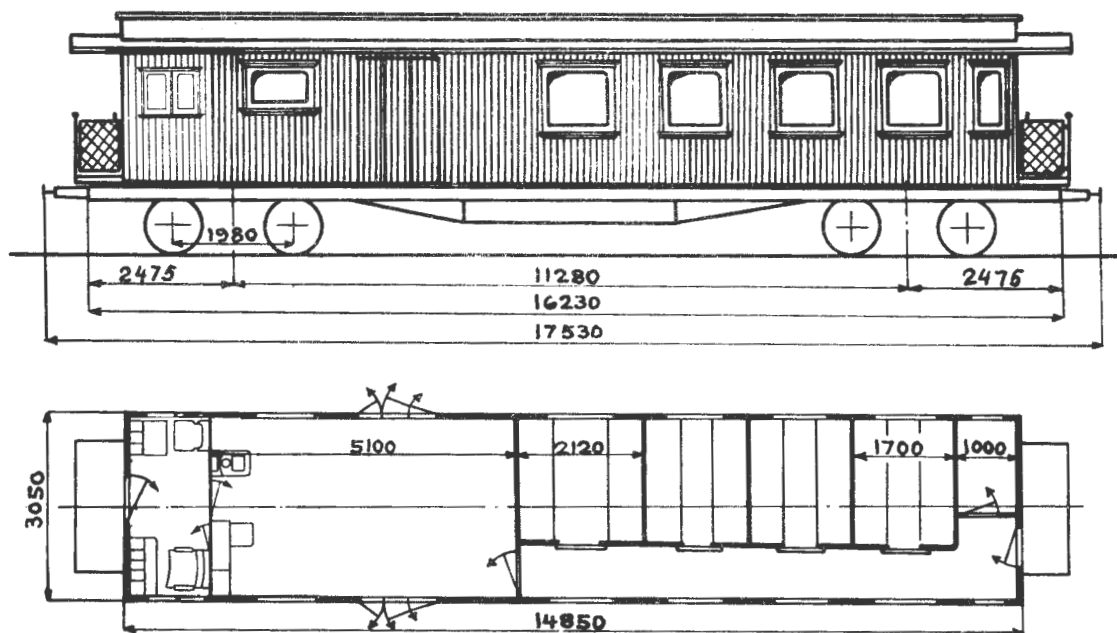
Oppr. hovedt. 142¹⁾

Vogn n.:	Distriktsmerke	Fabrikant	Byggeår	Omtr. vognvekt i tonn	Sittepl. 2. klasse	Reisegods, last i tonn	Grunnriss	El. varme i kW	Vognutstyr (se side 6)	Merknad
110	0	Skb	91	24,5	32	2,0			1H.3.5.10	

1) Forandr. etter 0.d. skisse dat. 1.11.37

BFo2b

TYPE 1

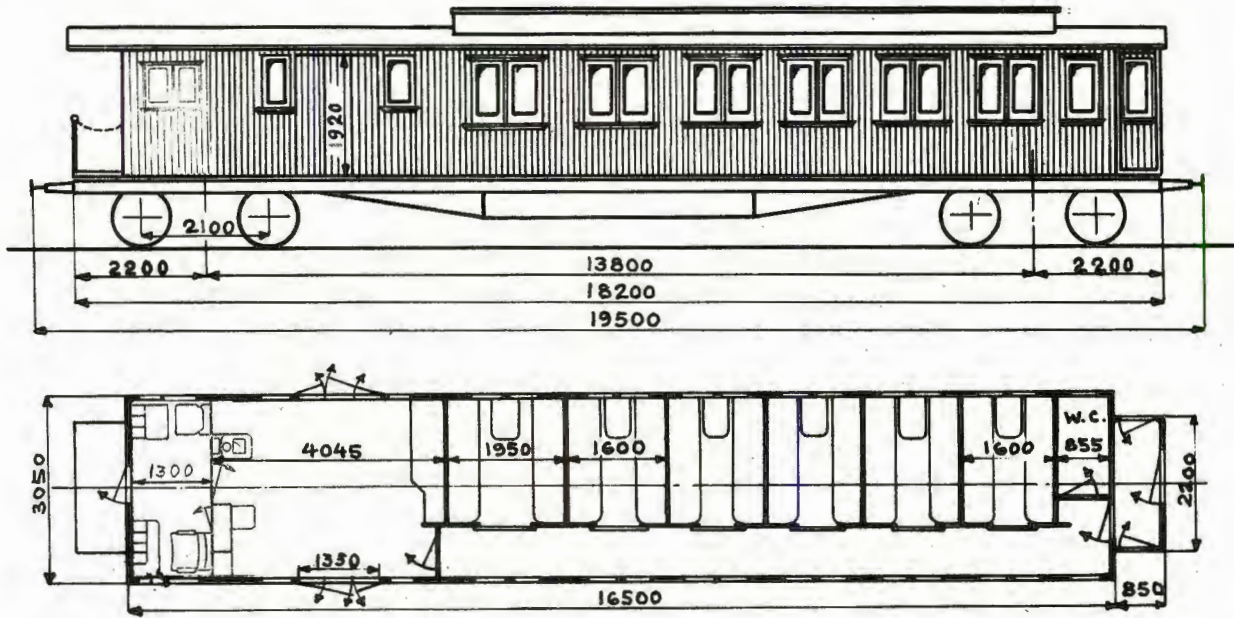

Oppr. hovedt. 702

Vogn n.:	Distriktsmerke	Fabrikant	Byggear	Omr. vognvekt i tonn	Sittepl. 2.klasse	Reisegods, last i tonn	Grunnriss	El. varme i kW	Vognutstyr (se side 6)	Merknad
965	B	Skb	04	28,0	48	2,0			1H.3.5.8.11.28	

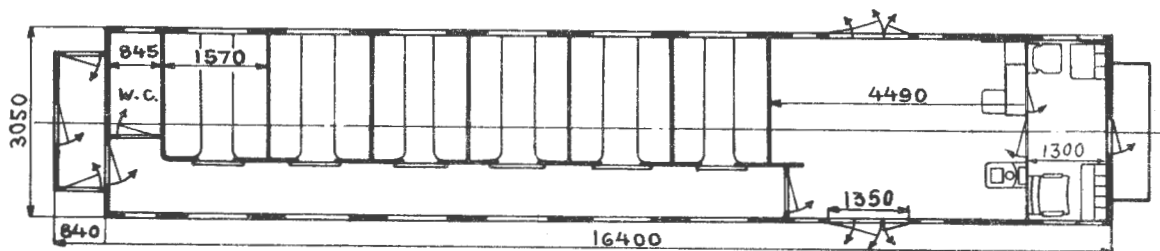
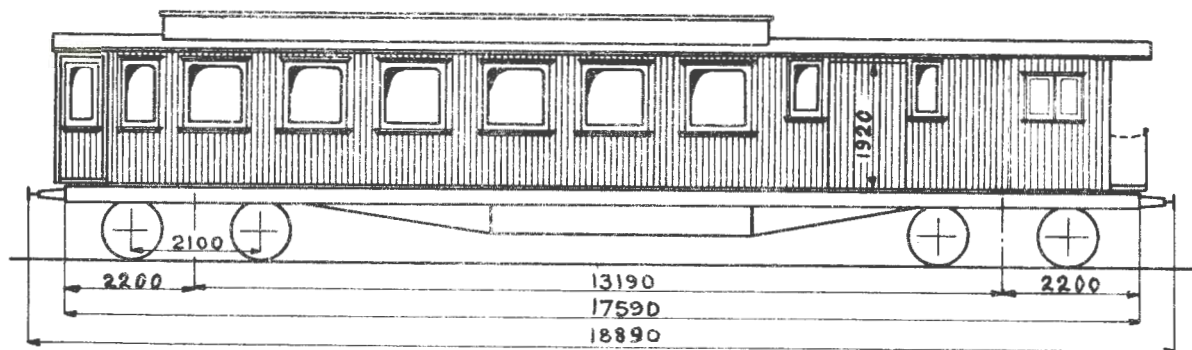

Hovedt. 612

Vogn nr.	Distriktsmerke	Fabrikant	Byggeår	Omtr. vognvekt i tonn	Sittepl. 2.klasse	Reisegods, last i tonn	Grunnriss	El. varme i kW	Vognutstyr (se side 6)	Merknad
778	H	Skb	09	28,5	48	1,0			1H.3.5.7.8.11	1)
837	T	Str	05	27,0	"	2,0			1H.3.5.7.8.11	
851	"	"	01	26,0	"	2,5			1H.3.5.7.8.11	

1) Oppr. hovedt. 745
Trykk nr. 751 1.7.57

BFo2b

TYPE 3

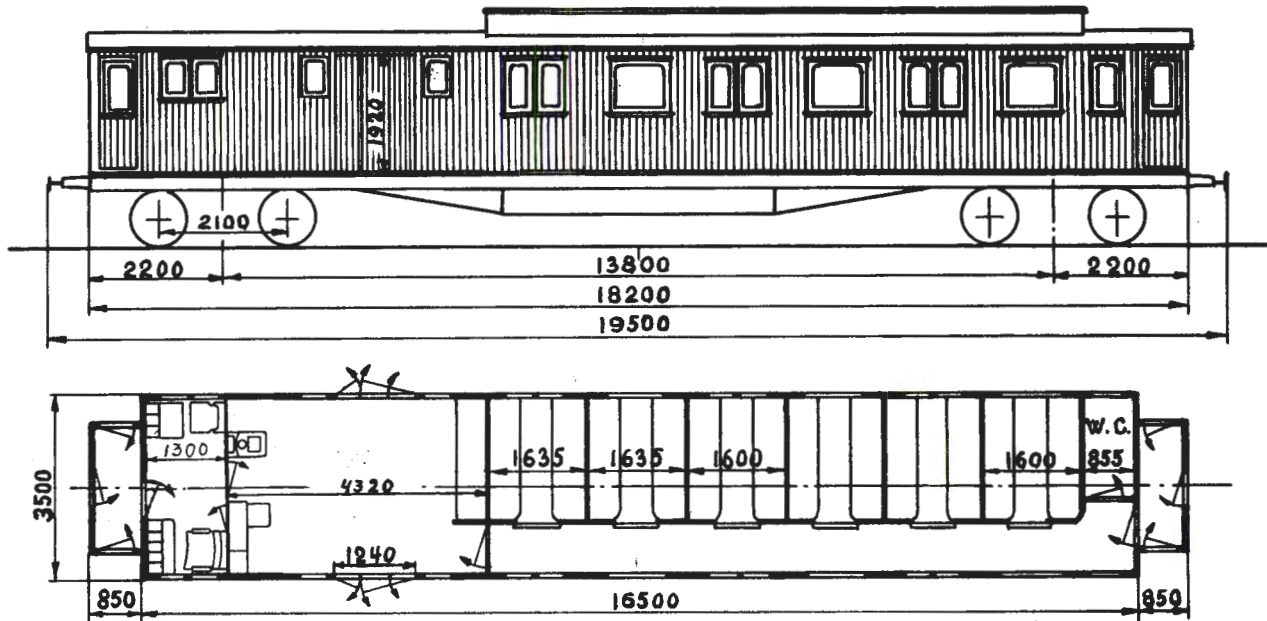

Oppr. hovedt. 701

Vogn nr.	Distriktsmerke	Fabrikant	Byggeår	Omtr. vognvekt i tonn	Sittepl. 2.klasse	Reisegods, last i tonn	Grunnriss	El. varme i kW	Vognutstyr (se side 6)	Merknad
940	B	Str	07	27,5	48	1,5			1H.3.5.8.11.28.39a	
941	"	"	08	28,5	"	"			1H.3.5.8.11.28 ¹⁾ .39a	
942	"	"	"	28,0	"	"			1H.3.5.8.11.28	

1) Bare i ende ved 2. kl. avd.

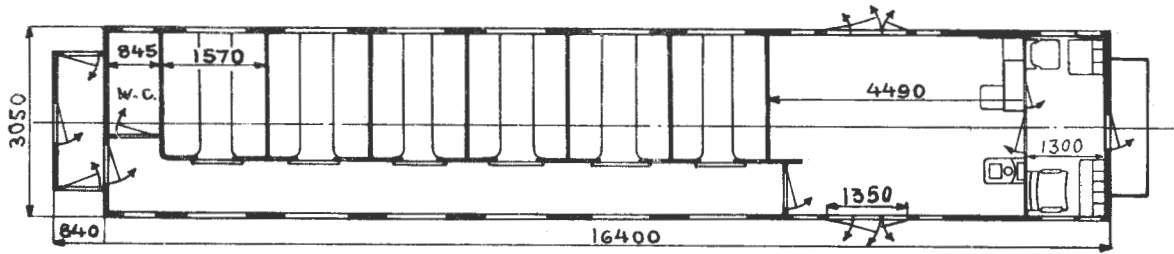
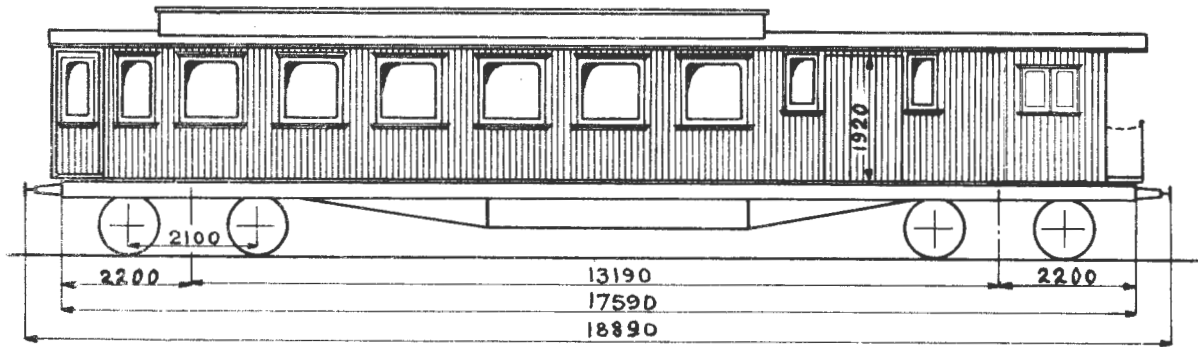

Hovedt. 612

Vogn nr.	Distriktsmerke	Fabrikant	Byggeår	Omtr. vognvekt i tonn	Sittepl. 2.klasse	Reisegods, last i tonn	Grunnriss	El. varme i kW	Vognutstyr (se side 6)	Merknad
778	H	Skb	09	28,5	48	1,0			1H.3.5.7.8.11	1)
837	T	Str	05	27,0	"	2,0			1H.3.5.7.8.11	
851	"	"	01	26,0	"	2,5			1H.3.5.7.8.11	

1) Oppr. hovedt. 745
Trykk nr. 751 1.7.57

BFo2b

TYPE 3

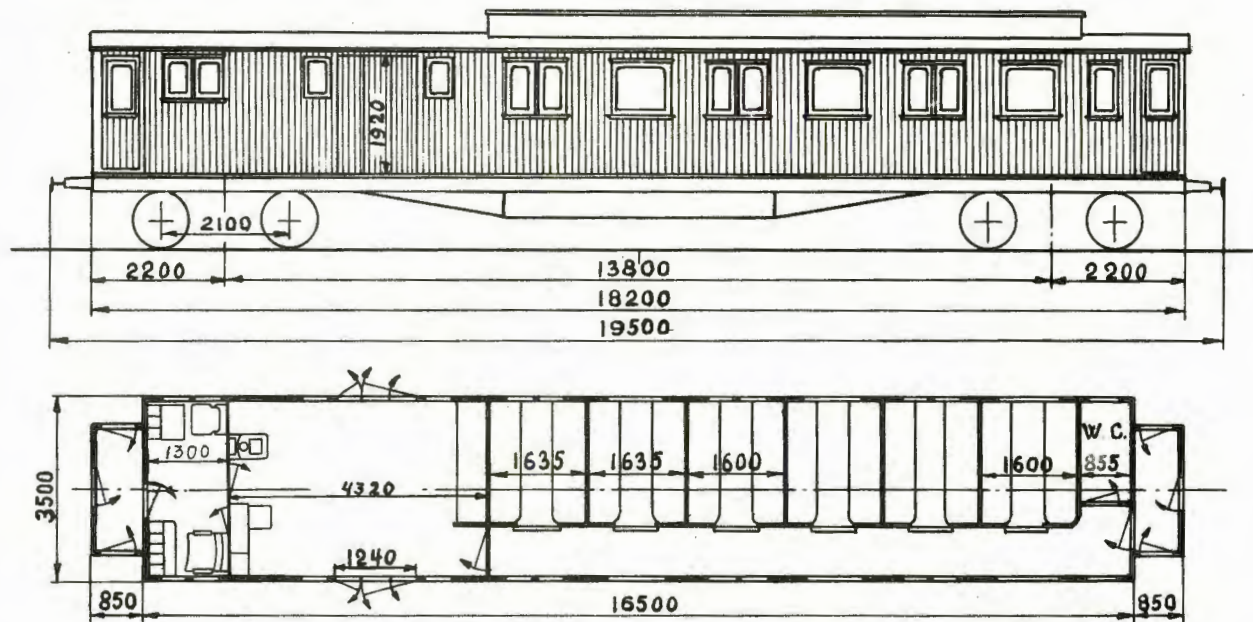

Oppr. hovedt. 701

Vogn nr.	Distriktsmerke	Fabrikant	Byggeår	Omr. vognvekt i tonn	Sittepl. 2.klasse	Reisegods, last i tonn	Grunnriss	El. varme i kW	Vognutstyr (se side 6)	Merknad
940	B	Str	07	27,5	48	1,5			1H.3.5.8.11.28.39a	
941	"	"	08	27,0	"	"			1H.3.5.8.11.28	
942	"	"	"	28,0	"	"			1H.3.5.8.11.28	

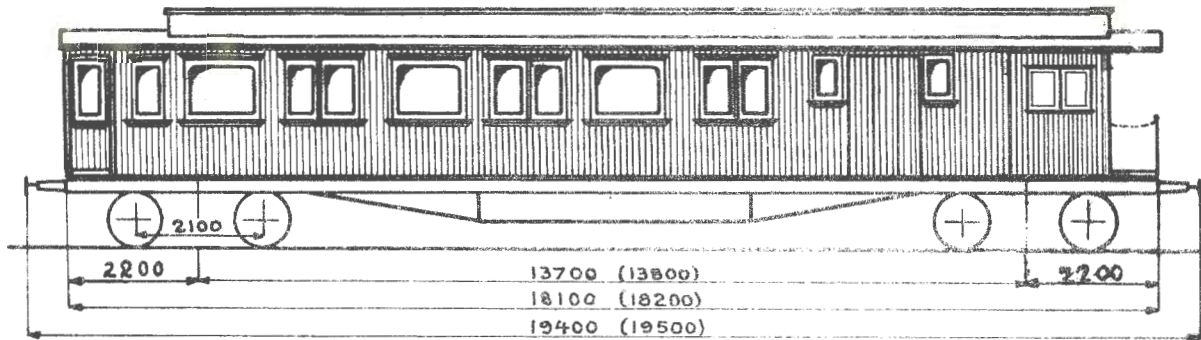

Mål i () gjelder vogner etter grunnriss 2. og 3

Grunnriss 1

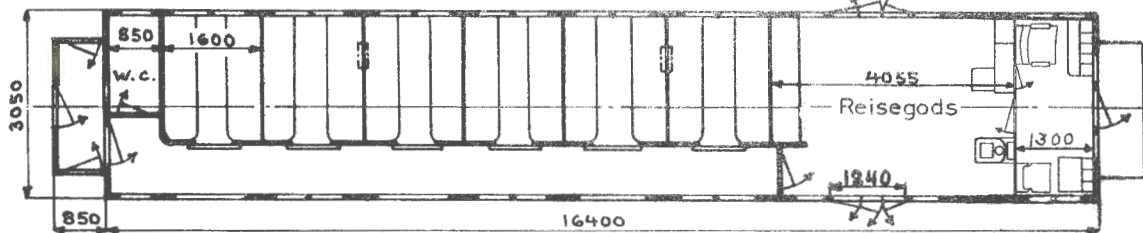

Hovedt. 976

Grunnriss 2

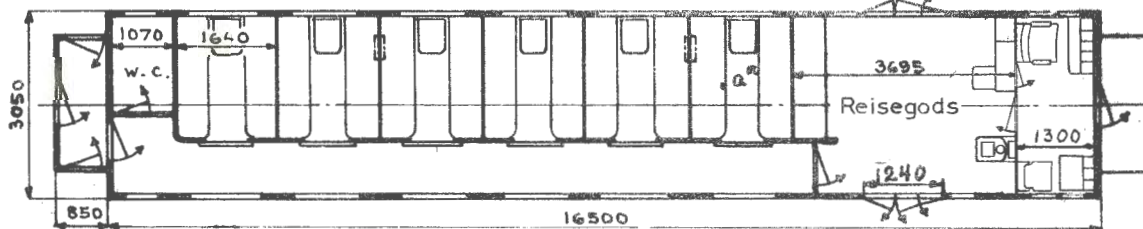

Hovedt. 1073

Grunnriss 3

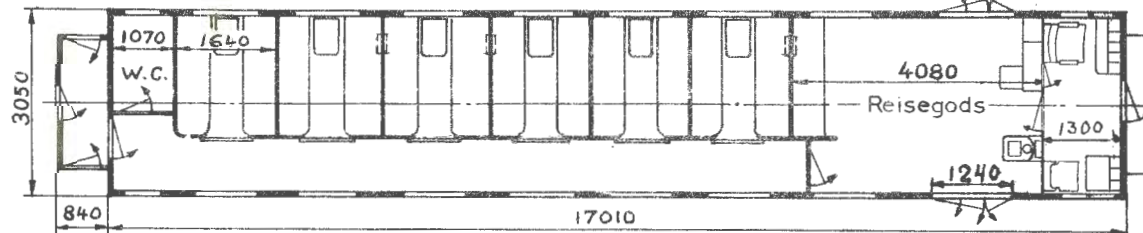

Hovedt. 1074

Vogn n.	Distriktsmerke	Fabrikant	Byggeår	Omr. vognvekt i tonn	Sittepl. 2.klasse	Reisegods, last i tonn	Grunnriss	El.varme i kW	Vognutstyr (se side 6)	Merknad
518	K	Skb	09	25,5	48	1,5	1		1H.3.6.7.11	
519	D	"	"	27,0	"	"	"		1H.3.5.7.11.39a	
779	H	"	10	29,0	"	"	3		1H.3.5.7.8.11	
976	0	"	"	31,0	"	"	2		1H.3.5.7.8.11.39a	Sykekupé "a"

BFo2b

TYPE 4

Vogn nr.	Distriktsmerke	Fabrikant	Byggear	Omt. vognvekt i tonn	Sittepl. 2.klasse	Reisegods, last i tonn	Grunnriss	El. varme i kW	Vognutstyr (se side 6)	Merknad
977	B	Skb	10	27,0	48	1,5	2		1H.3.5.7.8.11.39a	Sykekupé "a"
545	D	"	11	28,0	"	"	"		1H.3.5.8.11.28.39a	
812	T	"	"	30,0	"	"	3		1H.3.6.7.8.11	

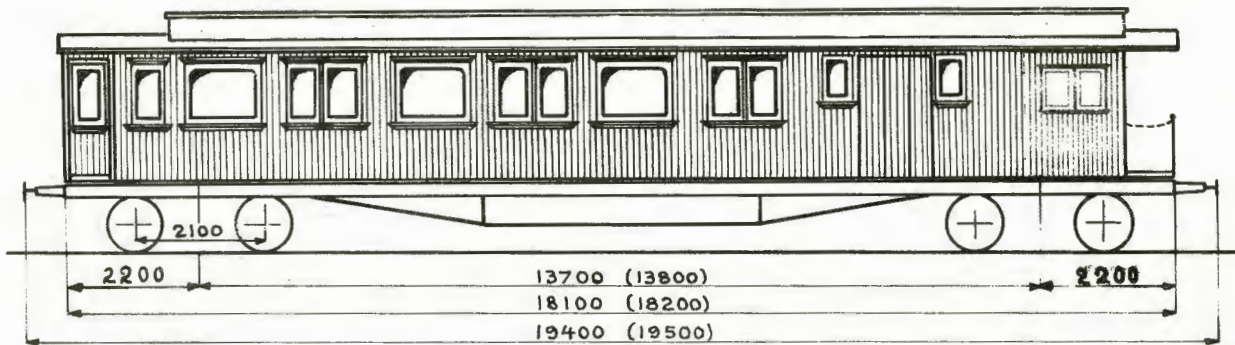

Mål i () gjelder vogner etter grunnriss 2. og 3.

Grunnriss 1

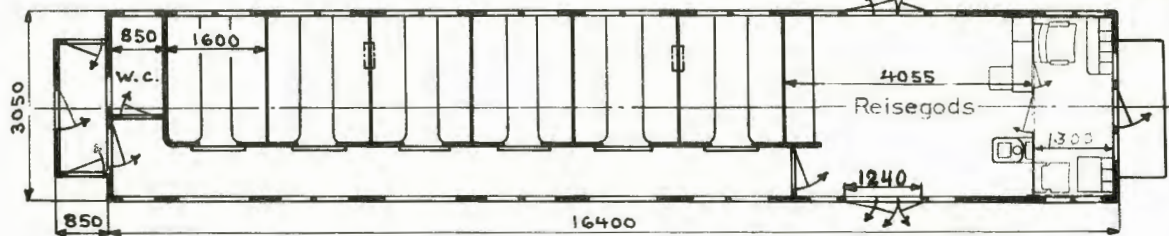
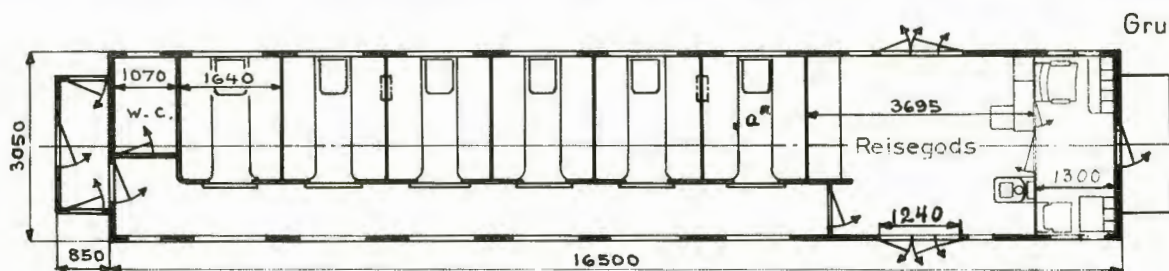
Hovedt.
976

Grunnriss 2

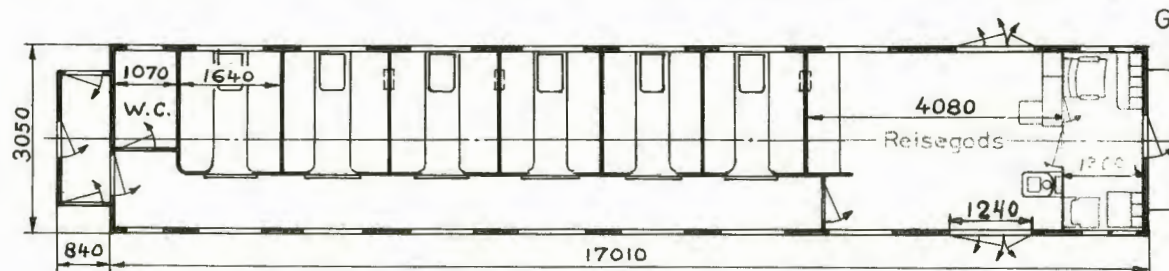
Hovedt.
1073

Grunnriss 3

Hovedt.
1074

Vogn nr.	Distriktsmerke	Fabrikant	Byggeår	Omr. vognvekt i tonn	Sittepl. 2.klasse	Reisegods, last i tonn	Grunnriss	El. varme i kW	Vognutstyr (se side 6)	Merknad
518	K	Skb	09	25,5	48	1,5	1		1H.3.6.7.11	
519	D	"	"	27,0	"	"	"		1H.3.5.7.11.39a	
545	"	"	11	28,0	"	"	2		1H.3.5.8.11.28.39a	Sykekupé "a"
779	H	"	10	29,0	"	"	3		1H.3.5.7.8.11	

BFo2b

TYPE 4

Vogn nr.	Distriktsmerke	Fabrikant	Byggeår	Omtr. vognvekt i tonn	Sittepl. 2.klasse	Reisegods, last i tonn	Grunnriss	El. varme i kW	Vognutstyr (se side 6)	Merknad
812	T	Skb	11	30,0	48	1,5	3		1H.3.5.7.8.11	
976	0	"	10	31,0	"	"	2		1H.3.5.7.8.11.39a	Sykekupé "a"
977	B	"	"	27,0	"	"	"		1H.3.5.8.11.39a	

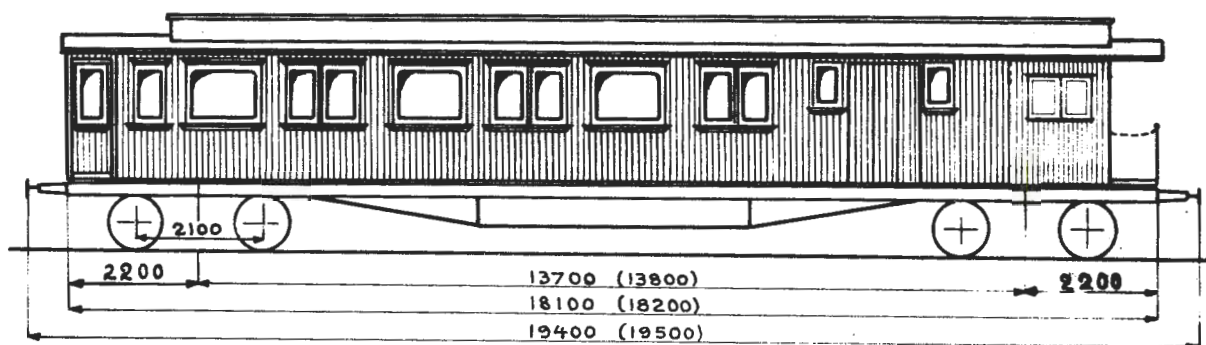

Mål i () gjelder vogner etter grunnriss 2. og 3.

Grunnriss 1

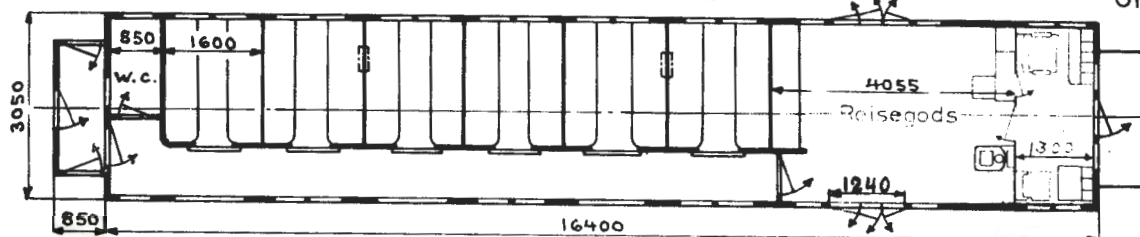
Hovedt.
976

Grunnriss 2

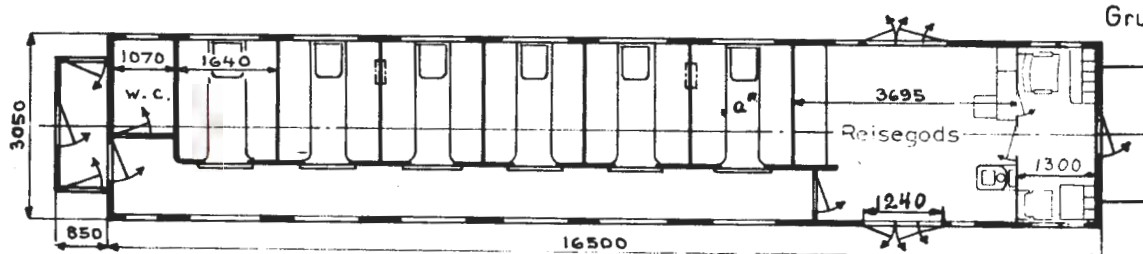
Hovedt.
1073

Grunnriss 3

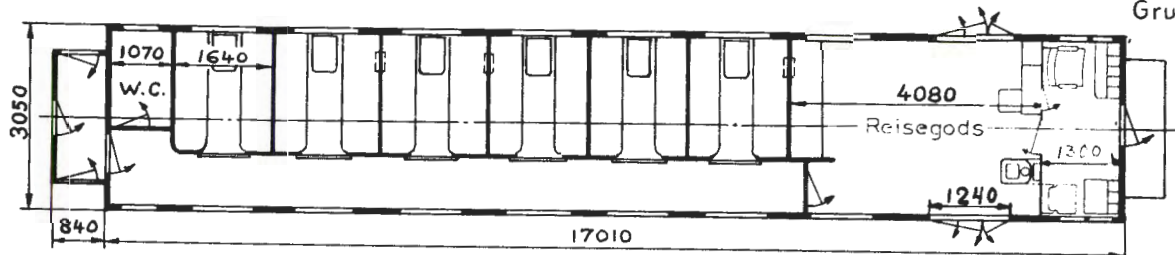
Hovedt.
1074

Vogn nr.	Distriktsmerke	Fabrikant	Byggeår	Omtr. vognvekt i tonn	Sittepl. 2.klasse	Reisegods, last i tonn	Grunnriss	El. varme i kW	Vognutstyr (se side 6)	Merknad
518	K	Skb	09	28,0	48	1,5	1		1H.3.6.11.39a	
519	D	"	"	27,0	"	"	"		1H.3.5.7.11.39a	
545	"	"	11	28,0	"	"	2		1H.3.5.8.11.28.39a	Sykekupé "a"
779	H	"	10	29,0	"	"	3		1H.3.5.7.8.11	

BFo2b

TYPE 4

Vogn nr.	Distriktsmerke	Fabrikant	Byggeår	Omtr. vognvekt i tonn	Site pl. 2.klasse	Reisegods, last i tonn	Grunnriss	El. varme i kW	Vognutstyr (se side 6)	Merknad
812	T	Skb	11	30,0	48	1,5	3		1H.3.5.7.8.11	Sykekupé "a"
976	O	"	10	31,0	"	"	2		1H.3.5.7.8.11.39a	
977	B	"	"	27,0	"	"	"		1H.3.5.8.11.39a	

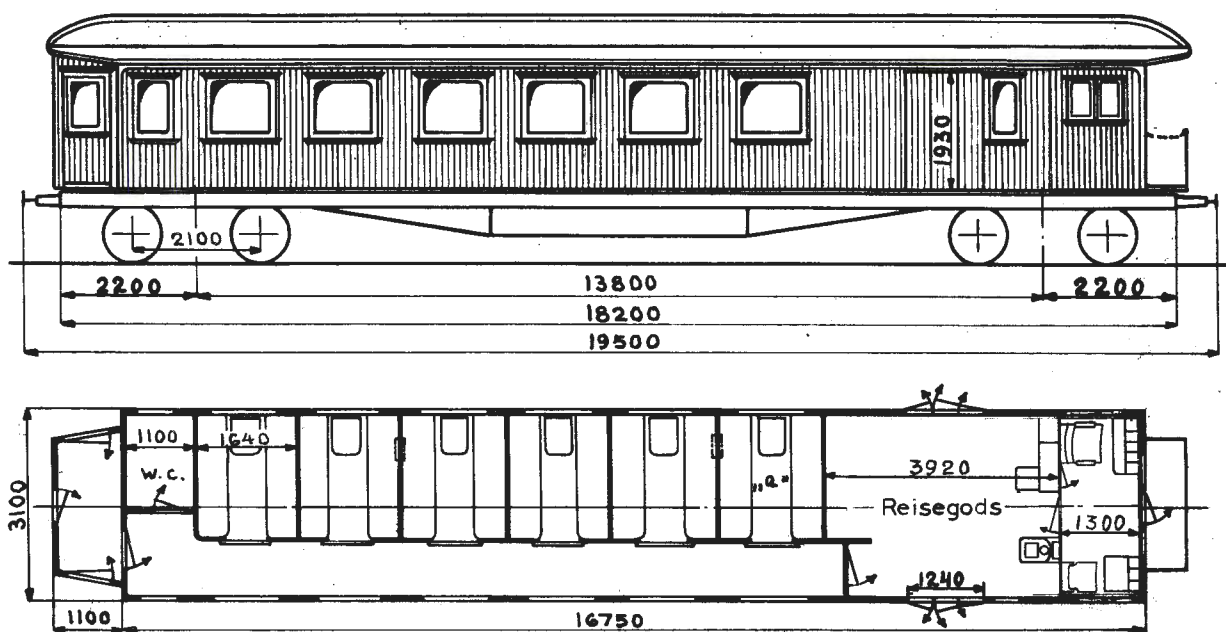

Hovedt. 2061

Vogn nr.	Distriktsmerke	Fabrikant	Byggeår	Omtr. vognvekt i tonn	Sittepl. 2.klasse	Reisegods, last i tonn	Grunnriss	El. varme i kW	Vognutstyr (se side 6)	Merknad
815	T	Skb	13	30,5	48	2,0			1H.3.5.7.8.11	Sykekupé "a"
18001	"	"	"	27,0	"	"			1H.3.5.7.8.11.39a	

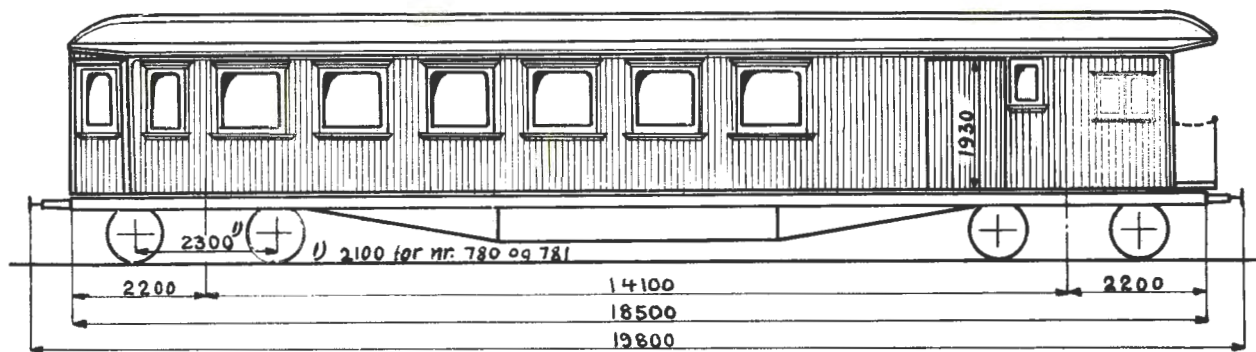

Grunnriss 1

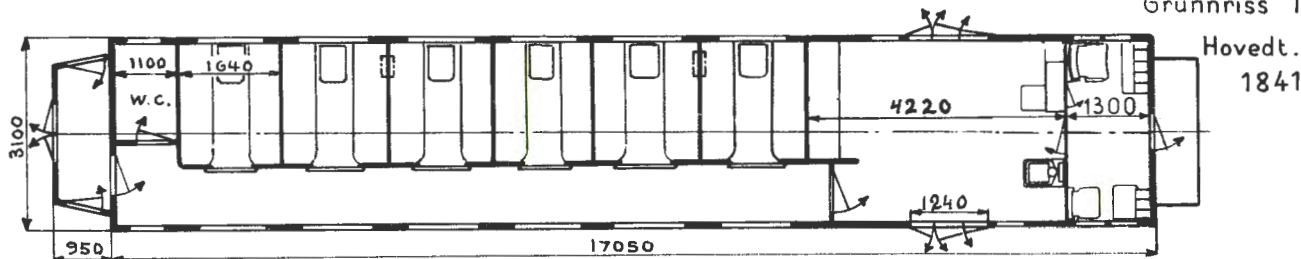

Hovedt. 1841

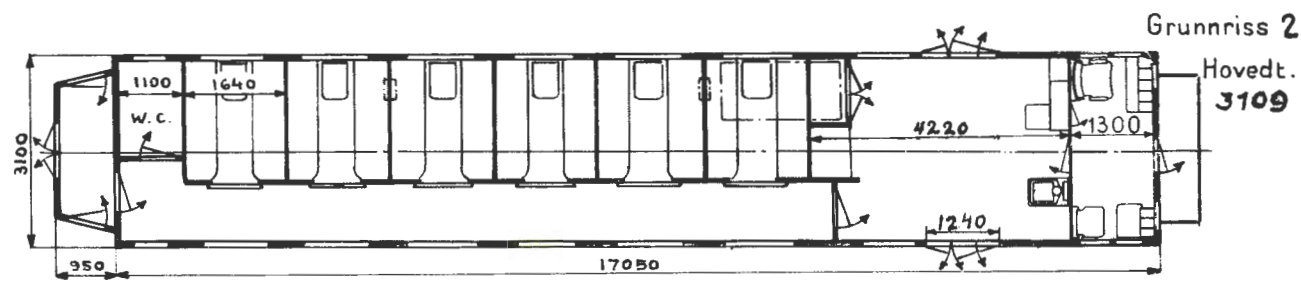

Grunnriss 2

Hovedt. 3109

Vogn nr.	Distriktsmerke	Fabrikant	Byggeår	Omr. vognvekt i tonn	Sittepl. 2.klasse	Reisegods, last i tonn	Grunnriss	El.varme i kW	Vognutstyr (se side 6)	Merknad
183	O	Str	17	33,0	48	3,0	2		1H.3.5.7.8.11.28	1)5)
575	D	"	15	30,5	"	"	1		1H.3.5.7.8.11.39a	
576	K	"	"	29,0	"	"	2		1H.3.5.7.8.11.39a	1)
577	D	"	"	"	"	"	1		1H.3.5.7.8.11.39a	
578	"	"	"	30,0	"	"	"		1H.3.6.7.8.11.39a	
649	"	"	29	34,0	"	"	2		1H.3.5.7.8.11.28.39a	
650	"	"	"	33,0	"	"	"		1H.3.5.7.8.11.28.39a	
776	H	"	21	32,5	"	"	"		1H.3.5.8.11.28.39a	1)
780	H	Skb	13	30,0	"	2,0	1		1H.3.5.7.8.11	3)
781	"	"	"	"	"	"	"		1H.3.5.7.8.11	3)
785	"	Str	21	32,0	"	3,0	"		1H.3.5.8.11.39a	

1) Oppr. hovedt. 1841
 3) " " 2060
 5) Kond.rom utv. til 1800 mm
 Trykk nr. 751 1.7.57

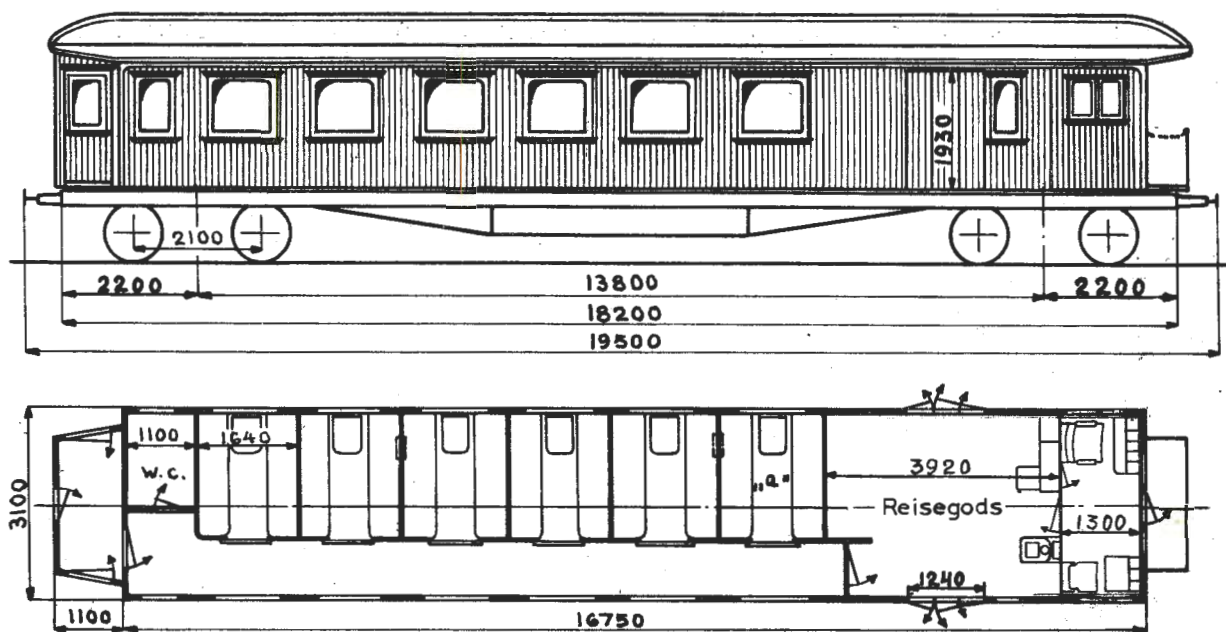

Hovedt. 2061

Vogn nr.	Distriktsmerke	Fabrikant	Byggear	Omtr. vognvekt i tonn	Sittepl. 2.klasse	Reisegods, last i tonn	Grunnriss	El.varme i kW	Vognutstyr (se side 6)	Merknad
815	T	Skb	13	30,5	48	2,0			1H.3.5.7.8.11	Sykekupé "a"
18001	"	"	"	27,0	"	"			1H.3.5.7.8.11.39a	

BFo2b

TYPE 6

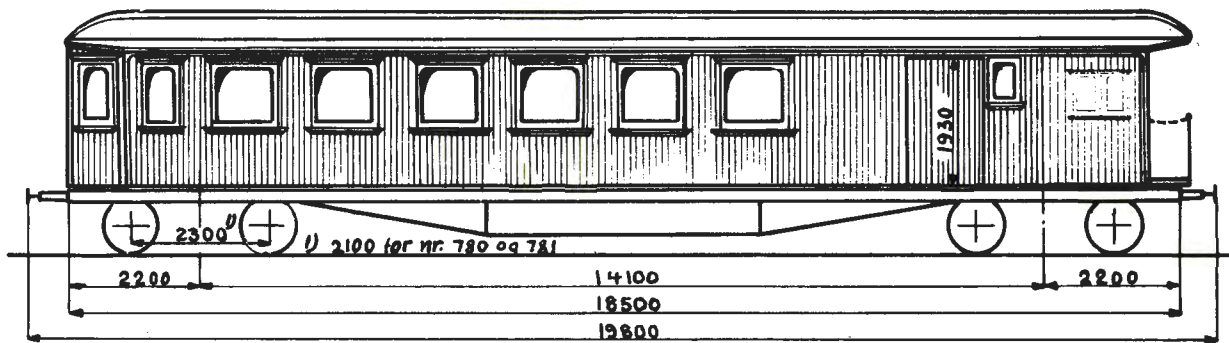

Grunnriss 1

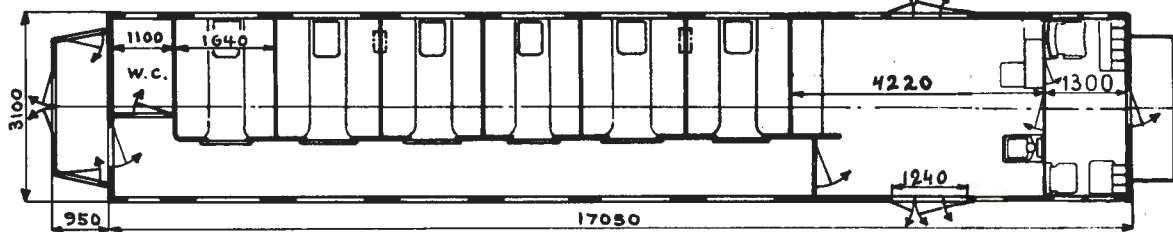

Hovedt.
1841

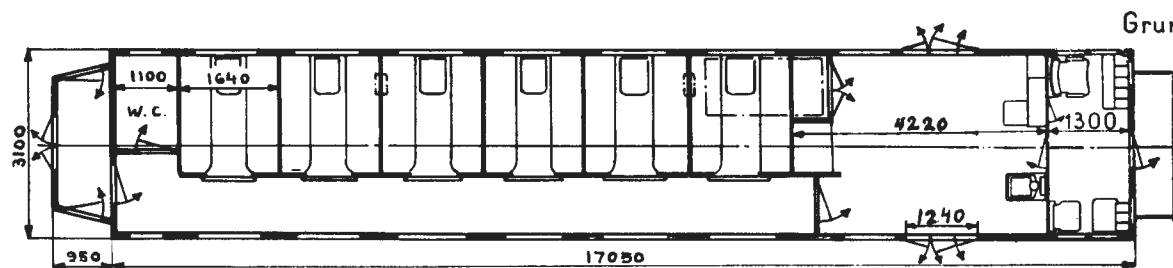

Grunnriss 2

Hovedt.
3109

Vogn n.	Distriktsmerke	Fabrikant	Byggear	Omtr. vognvekt i tonn	Sittepl. 2.klasse	Reisegods, last i tonn	Grunnriss	El.varme i kW	Vognutstyr (se side 6)	Merknad
183	O	Str	17	32,5	48	3,0	2		1H.3.5.8.11.28.39a	1)5)
575	D	"	15	30,5	"	"	1		1H.3.5.7.8.11.39a	
576	K	"	"	33,5	"	"	2		1H.3.5.7.8.11.39a	1)
577	D	"	"	"	"	"	1		1H.3.5.7.8.11.39a	
578	"	"	"	30,0	"	"	"		1H.3.6.7.8.11.39a	
649	"	"	29	34,0	"	"	2		1H.3.5.7.8.11.28.39a	
650	"	"	"	33,0	"	"	"		1H.3.5.7.8.11.28.39a	
776	H	"	21	32,5	"	"	"		1H.3.5.8.11.28.39a	1)
780	H	Skb	13	30,0	"	2,0	1		1H.3.5.7.8.11	3)
781	"	"	"	"	"	"	"		1H.3.5.7.8.11	3)
785	"	Str	21	32,0	"	3,0	"		1H.3.5.8.11.39a	

1) Oppr. hovedt. 1841

3) " " 2060

5) Kond.rom utv. til 1800 mm
Trykk nr. 751 1.7.58

Vogn nr.	Distriktsmerke	Fabrikant	Byggear	Omtr. vognvekt i tonn	Sittepl. 2.klasse	Reisegods, last i tonn	Grunnriss	El. varme i kW	Vognutstyr (se side 6)	Merknad
792	H	Str	23	33,5	48	3,0	2		1H.3.5.7.8.11.28	
793	"	"	"	31,5	"	"	"		1H.3.5.8.11.28.39a	
794	"	"	"	32,5	"	"	"		1H.3.5.7.8.11.28	
795	"	"	"	32,0	"	"	"		1H.3.5.7.8.11.28	1)
796	"	"	24	33,0	"	"	"		1H.3.5.7.8.11.28.39a	1)
797	"	"	"	"	"	"	"		1H.3.5.7.8.11.28.39a	1)
18019	T	Skb	15	"	"	2,0	1		1H.3.5.7.8.11.28	2)
18020	"	"	"	"	"	"	"		1H.3.5.7.8.11.28	2)
18021	"	"	"	"	"	"	"		1H.3.5.7.8.11.28	2)
18022	"	"	"	32,5	"	"	"		1H.3.5.7.8.11.28	2)
18023	"	"	"	32,0	"	"	"		1H.3.5.7.8.11	2)
18043	"	"	18	34,5	"	3,0	2		1H.3.5.7.8.11.28	4)
18044	"	"	"	32,0	"	2,0	1		1H.3.5.7.8.11	4)
18052	T	Str	17	33,0	"	3,0	2		1H.3.5.7.8.11.28	1)
18079	"	Skb	21	32,5	"	2,0	1		1H.3.5.7.8.11	
18100	B	Str	"	32,0	"	3,0	"		1H.3.5.7.8.11.39a	
18104	"	"	"	32,5	"	"	2		1H.3.5.7.8.11.39a	
18105	"	"	"	32,0	"	"	1		1H.3.5.7.8.11.28	

- 1) Oppr. hovedt. 1841
 2) " " 1842
 4) " " 2176

BFo2b

TYPE 7

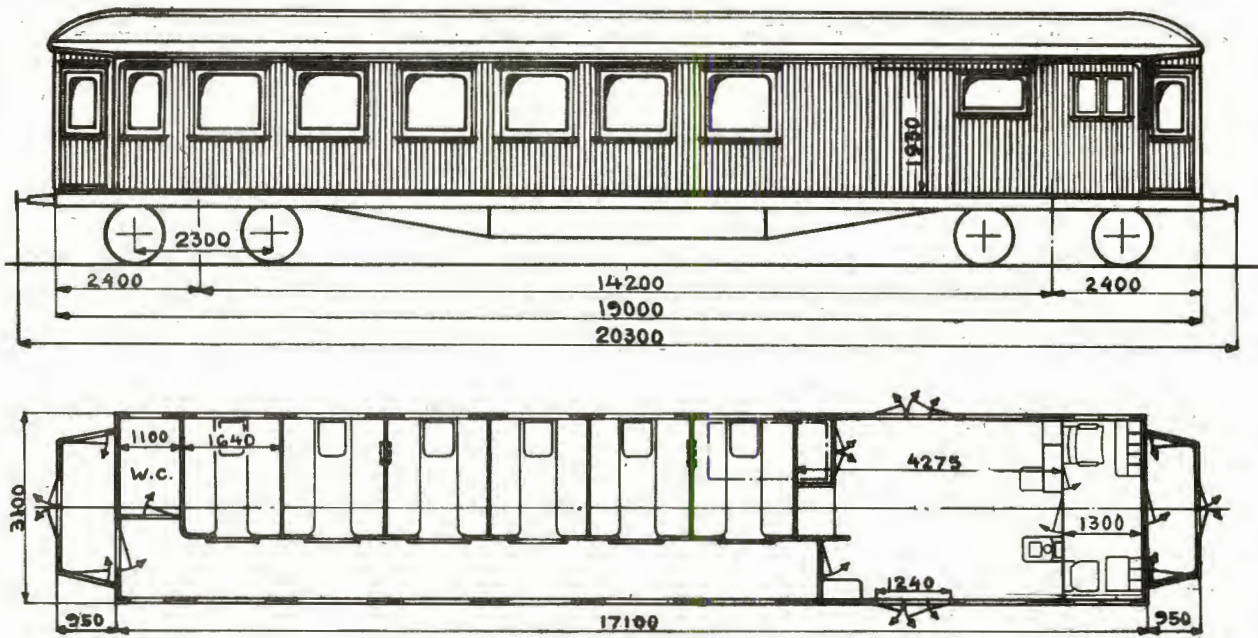

Hovedt. 3236

Vogn nr.	Distriktsmerke	Fabrikant	Byggeår	Omtr. vognvekt i tonn	Sittepl. 2.klasse	Reisegods, last i tonn	Grunnriss	El.varme i kW	Vognutstyr (se side 6)	Merknad
18130	S	Skb	31	30,6	48	2,5			1H.3.5.8.11.39a	

Vogn nr.	Distriktsmerke	Fabrikant	Byggeår	Omtr. vognvekt i tonn	Sittepl. 2.klasse	Reisegods, last i tonn	Grunnriss	El. varme i kW	Vognutstyr (se side 6)	Merknad
792	H	Str	23	33,5	48	3,0	2		1H.3.5.7.8.11.28	
793	"	"	"	31,5	"	"	"		1H.3.5.8.11.28.39a	
794	"	"	"	32,5	"	"	"		1H.3.5.7.8.11.28	
795	"	"	"	32,0	"	"	"		1H.3.5.7.8.11.28	1)
796	"	"	24	33,0	"	"	"		1H.3.5.7.8.11.28.39a	1)
18019	T	Skb	15	"	"	2,0	1		1H.3.5.7.8.11.28	2)
18020	"	"	"	"	"	"	"		1H.3.5.7.8.11.28	2)
18021	"	"	"	"	"	"	"		1H.3.5.7.8.11.28	2)
18022	"	"	"	32,5	"	"	"		1H.3.5.7.8.11.28	2)
18023	"	"	"	32,0	"	"	"		1H.3.5.7.8.11	2)
18043	"	"	18	34,5	"	3,0	2		1H.3.5.7.8.11.28	4)
18044	"	"	"	32,0	"	2,0	1		1H.3.5.7.8.11	4)
18052	T	Str	17	33,0	"	3,0	2		1H.3.5.7.8.11.28	1)
18079	"	Skb	21	32,5	"	2,0	1		1H.3.5.7.8.11	
18100	B	Str	"	32,0	"	3,0	"		1H.3.5.7.8.11.39a	
18104	"	"	"	32,5	"	"	2		1H.3.5.7.8.11.39a	
18105	"	"	"	32,0	"	"	1		1H.3.5.7.8.11.28	

1) Oppr. hovedt. 1841

2) " " 1842

4) " " 2176

BFo2b

TYPE 7

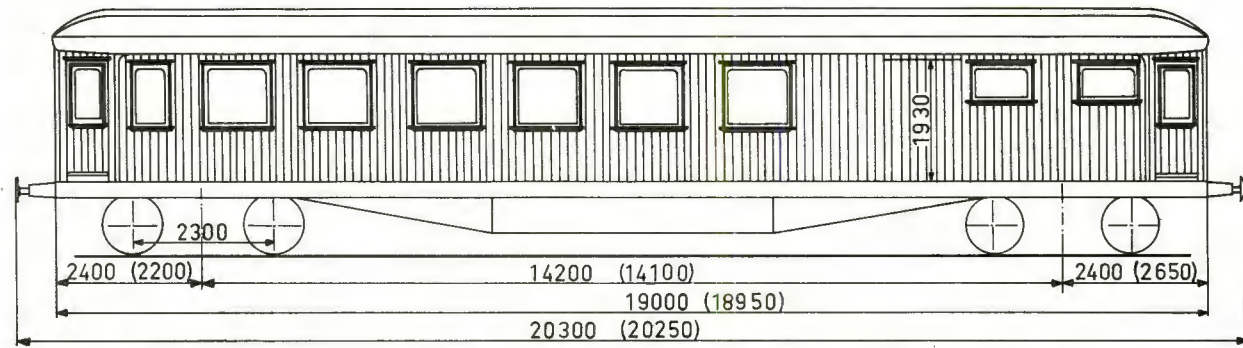

Mål i () gjelder for grunnriss 2

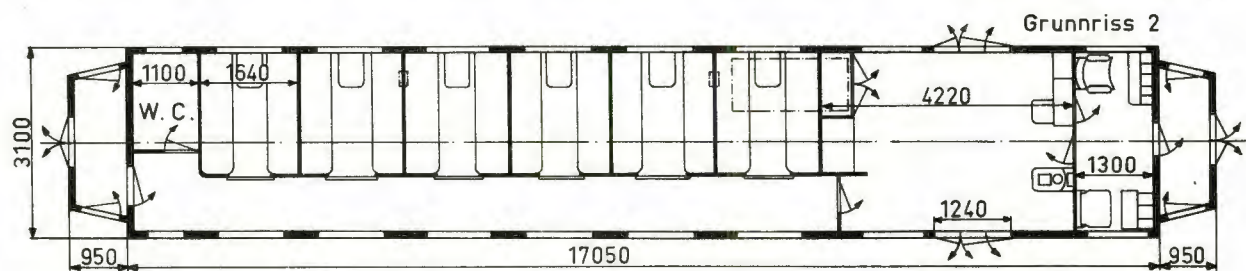
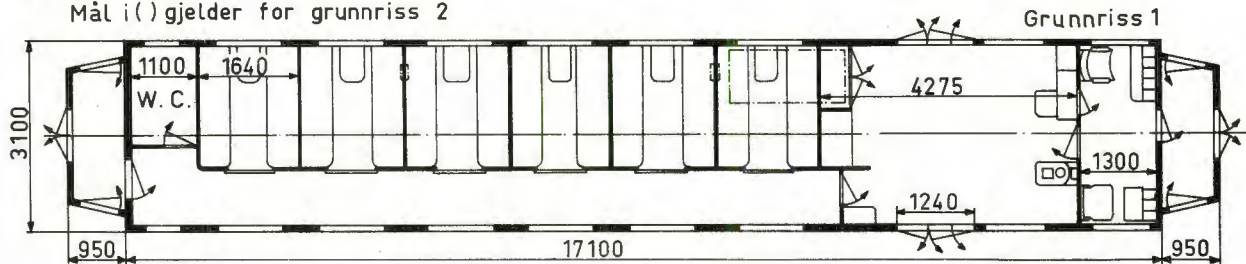

Hovedt. gr.r. 1: 3236 gr.r. 2: 3109.

Vogn nr.	Distriktsmerke	Fabrikant	Byggeår	Omr. vognvekt i tonn	Sittepl. 2. klasse	Reisegods, last i tonn	Grunnriss	EL. varme i kW	Vognutstyr (se side 6)	Merknad
18130	S	Skb	31	30,5	48	2,5	1		1H. 3. 5. 8. 11. 39a	
797	H	Str	24	33,0	•	3,0	2		1H. 3. 5. 7. 8. 11. 28. 39a	1)

1) Oppr. hovedt. 1841

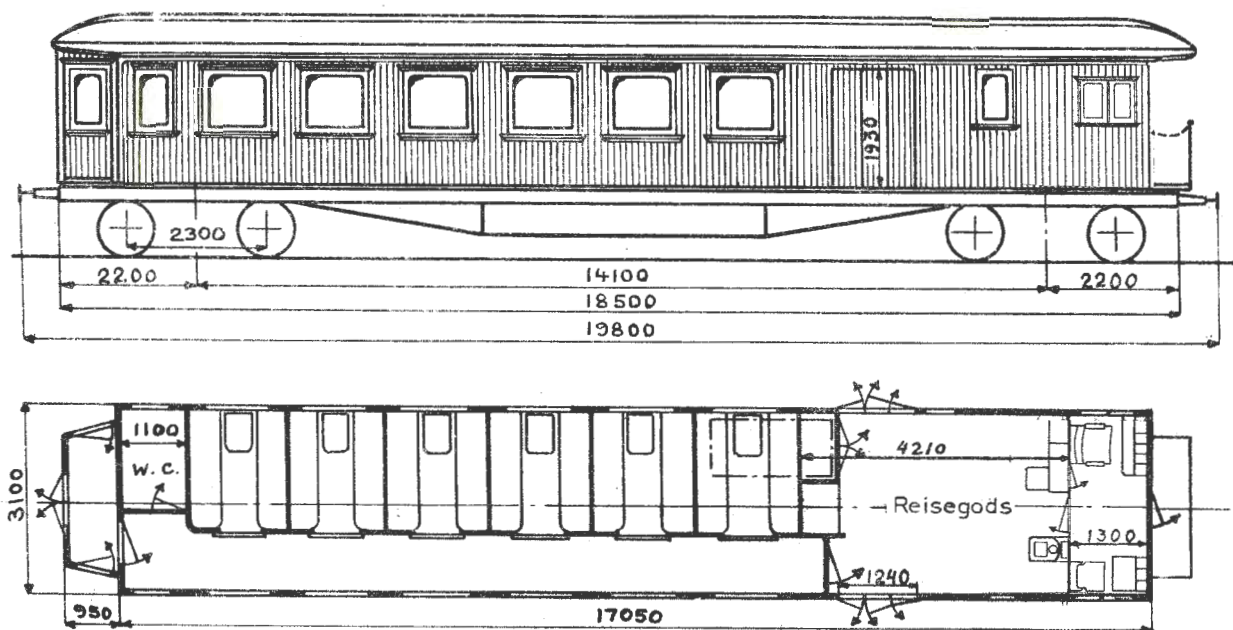

Oppr. hovedt. 2176

Vogn nr.	Distriktsmerke	Fabrikant	Byggear	Omr. vognvekt i tonn	Sittepl. 2.klasse	Reisegods, last i tonn	Grunnriss	El. varme i kW	Vognutstyr (se side 6)	Merknad
604	D	Str	21	33,0	48	2,5			1H.3.5.8.11.28.39a	
624	"	"	"	33,5	"	6,0			1H.3.5.7.8.11.28.39a	
625	"	Skb	22	32,5	"	2,5			1H.3.5.8.11.28.39a	
626	"	"	"	33,0	"	6,0			1H.3.5.8.11.28.39a	

BFo2b

TYPE 9

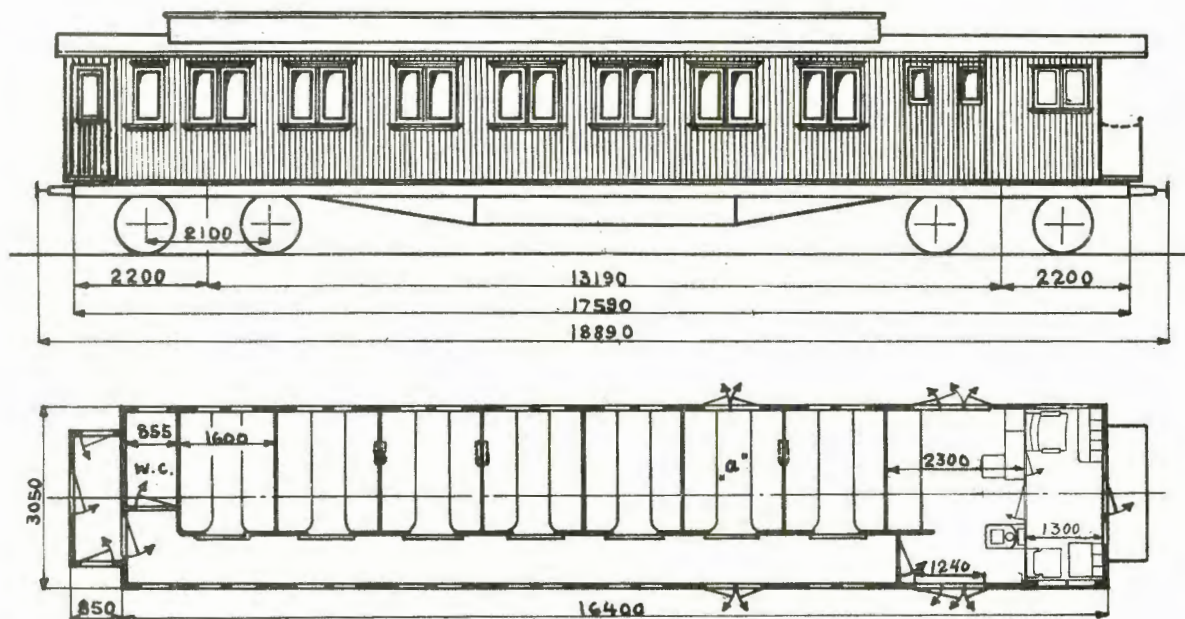

Hovedt. 745

Vogn nr.	Distriktsmerke	Fabrikant	Byggeår	Omr. vognvekt i tonn	Sittepl. 2. klasse	Reisegods, last i tonn	Grunnriss	El. varme i kW	Vognutstyr (se side 6)	Merknad
837	T	Str	05	26,0	56	1,0			1H.3.6.7.11	Sykekupé "a"

BFo2c

TYPE 1

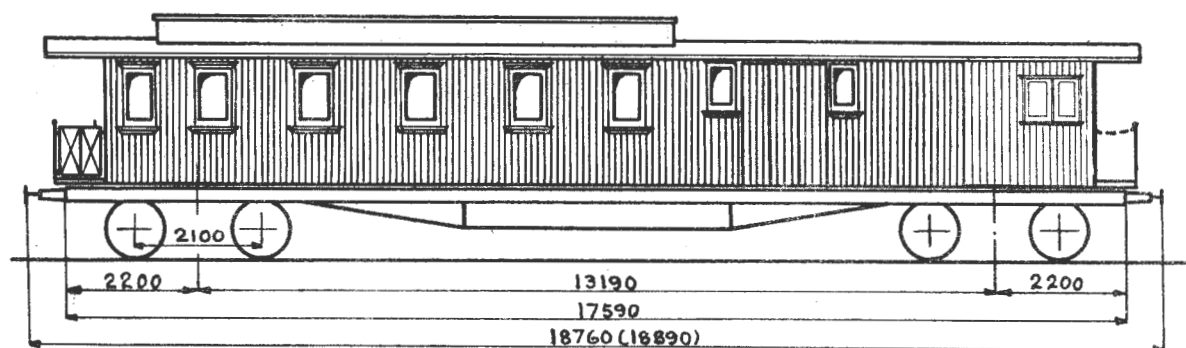

Grunnriss 1

Hovedt.
502

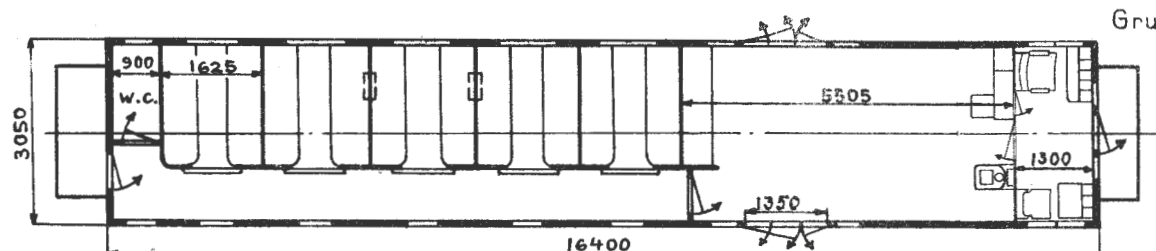

Grunnriss 2

Hovedt.
B.112

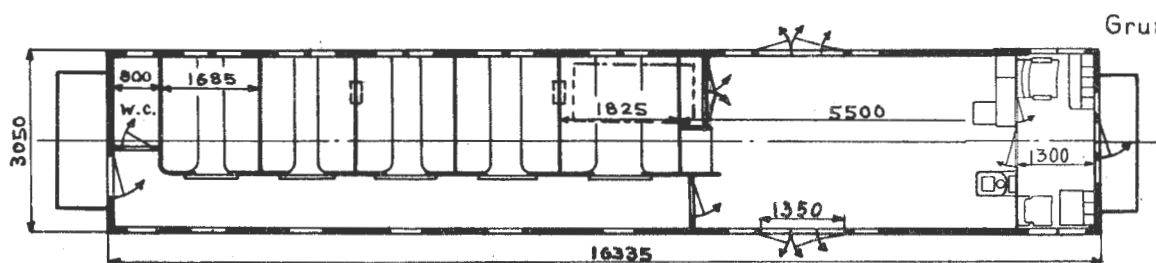

Vogn nr.	Distriktsmerke	Fabrikant	Byggeår	Omr. vognvekt i tonn	Sittepl. 2.klasse	Reisegods, last i tonn	Grunnriss	El. varme i kW	Vognutstyr (se side 6)	Merknad
94	O	Skb	01	27,5	40	2,0	2		1H.3.5.7.8.11.39a	
806	H	Str	"	27,0	"	"	1		1H.3.5.7.8.11	
807	"	"	"	26,5	"	"	"		1H.3.6.7.8.11	

BFo2c

TYPE 2

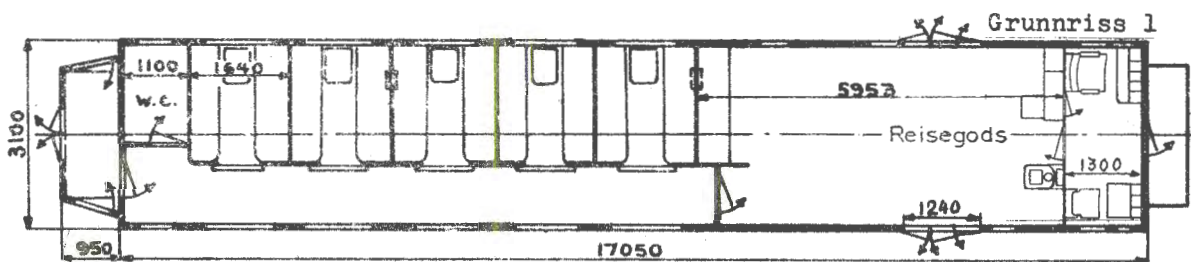
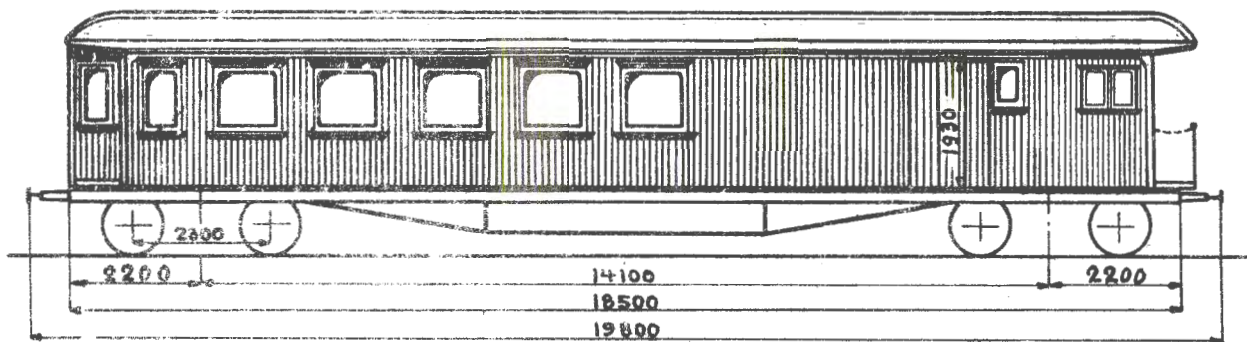

Hovedt. 2126

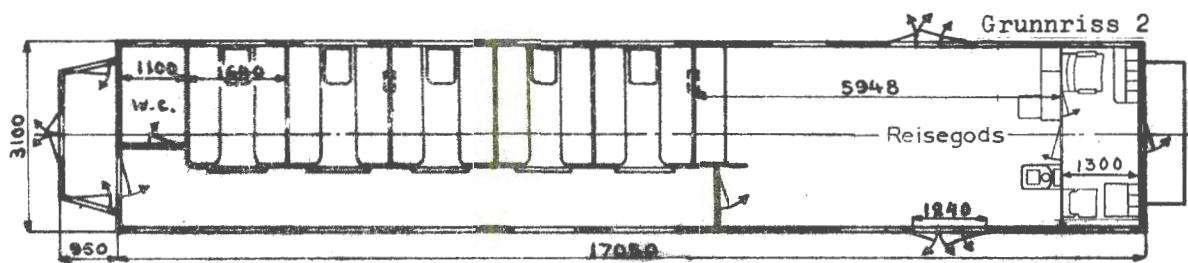

Hovedt. 2126
3052

Vogn nr.	Distriktsmerke	Fabrikant	Byggeår	Omtr. vognvekt i tonn	Sittepl. 2. klasse	Reisegods, last i tonn	Grunnriss	El. varme i kW	Vognutstyr (se side 6)	Merknad
18015	D	Skb	15	33,0	40	4,0	1	1H.3.5.7.8.11.28.39a	Utvidet forgang	
296	0	Str	16	32,0	"	"	"	1H.3.5.7.8.11		
882	"	"	"	"	"	"	"	1KK.3.5.8.11.28.39a	Sykekupé m. inng. fra reiseg.r.	
888	"	Skb	"	"	"	"	"	1H.3.5.7.8.11.39a		
184	"	Str	17	31,0	"	"	"	1H.3.5.8.11.28.39a		
879	"	"	"	32,0	"	"	"	1KK.3.5.8.12.39a		
185	"	"	21	30,0	"	"	"	1H.3.5.7.8.11.28.39a		
852	D	"	"	33,0	"	"	"	1H.3.5.8.11.28.39a		
97	0	"	23	32,5	"	"	2	1H.3.5.7.8.11.39a		
98	"	"	"	33,0	"	"	"	1H.3.5.7.8.11.39a		
188	"	"	25	32,5	"	"	"	1H.3.5.7.8.11		

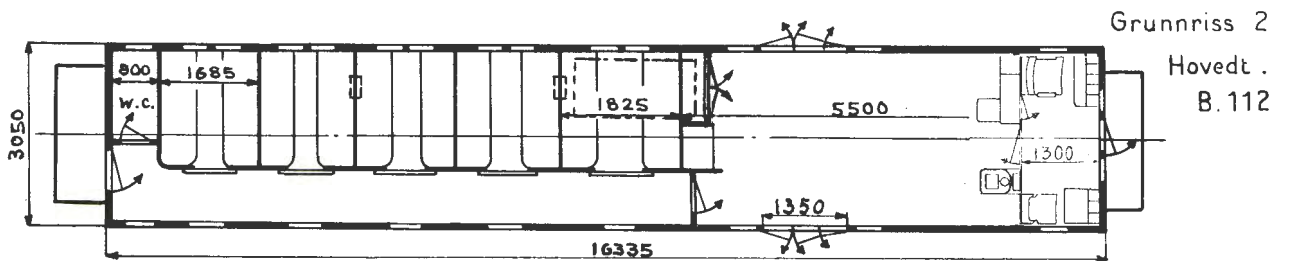
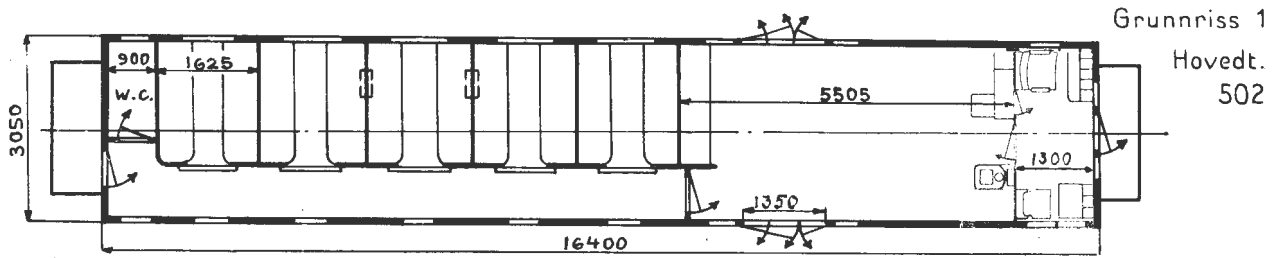
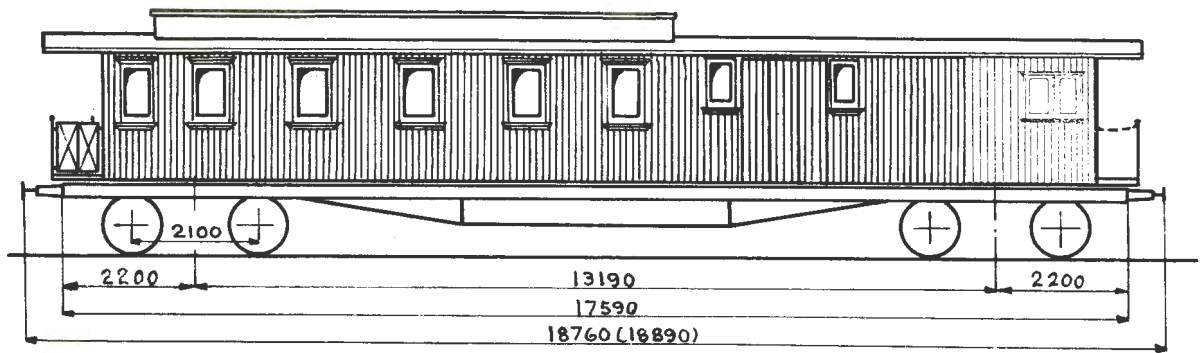

Vogn nr.	Distriktsmerke	Fabrikant	Byggeår	Omtr. vognvekt i tonn	Sittepl. 2.klasse	Reisegods, last i tonn	Grunnriss	El. varme i kW	Vognutstyr (se side 6)	Merknad
94	0	Skb	01	27,5	40	2,0	2		1H.3.5.7.8.11.39a	
806	H	Str	"	27,0	"	"	1		1H.3.6.7.8.11	
807	"	"	"	26,5	"	"	"		1H.3.6.7.8.11	

BFo2c

TYPE 2

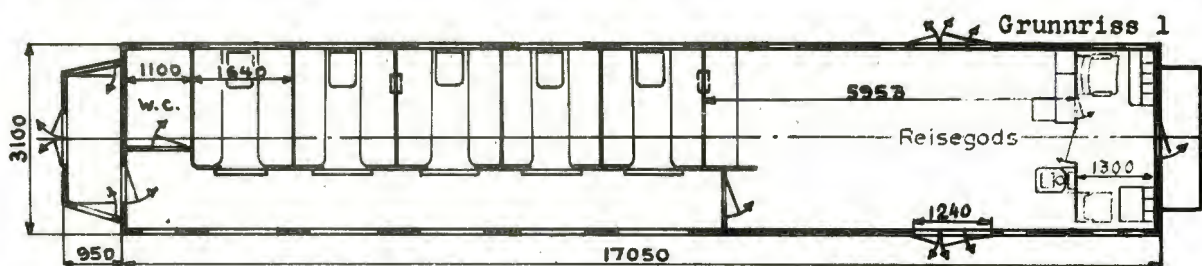
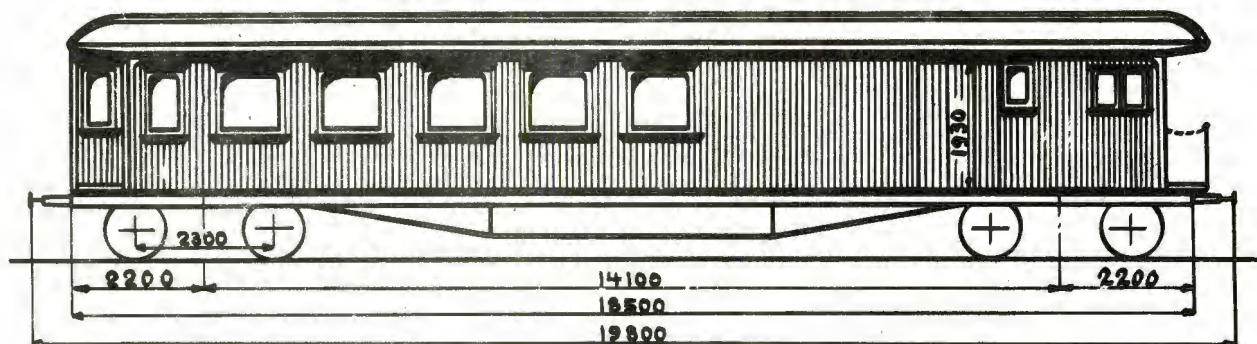

Hovedt. 2126

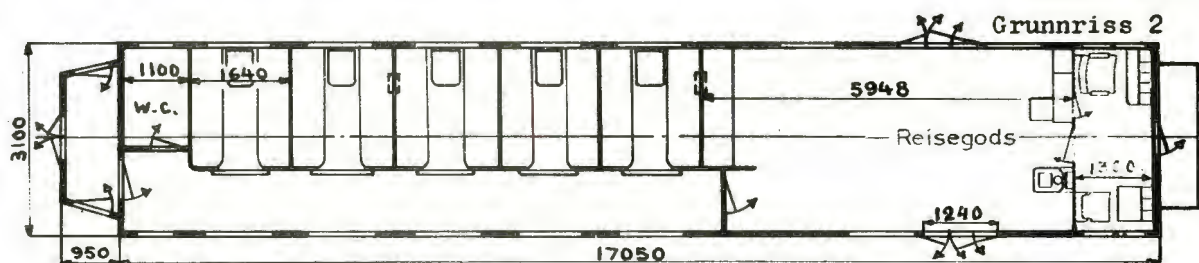

Hovedt. 2126
3052

Vogn nr.	Distriktsmerke	Fabrikant	Byggeår	Omtr. vognvekt i tonn	Sittepl. 2.klasse	Reisegods, last i tonn	Grunnriss	El. varme i kW	Vognutstyr (se side 6)	Merknad
97	0	Str	23	32,5	40	4,0	2		1H.3.5.7.8.11.39a	
98	"	"	"	33,0	"	"	"		1H.3.5.7.8.11.28.39a	
120	"	"	28	31,5	"	"	"		1H.3.5.8.11.39a	1)
121	"	"	"	30,5	"	"	"		1H.3.5.7.8.11.28.39a	
184	"	"	17	31,0	"	"	1		1H.3.5.8.11.28.39a	
185	"	"	21	30,0	"	"	"		1H.3.5.7.8.11.28.39a	
188	"	"	25	30,5	"	"	2		1H.3.5.8.11.39a	2)
296	"	"	16	32,0	"	"	1		1H.3.5.7.8.11	
647	D	"	27	31,0	"	"	2		1H.3.5.7.8.11.28.39a	
648	"	"	"	"	"	"	"		1H.3.5.7.8.11.28.39a	
852	"	"	21	33,0	"	"	1		1H.3.5.8.11.28.39a	

- 1) Kond.rom utv. til 1800 mm
 2) Sykekupé med inng. fra reiseg.r.
 Trykk nr. 751 1.7.57

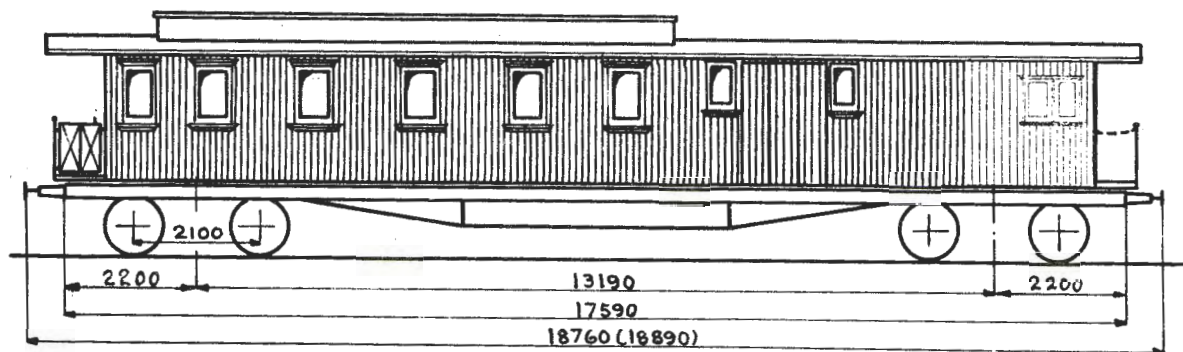

Grunnriss 1

Hovedt. 502

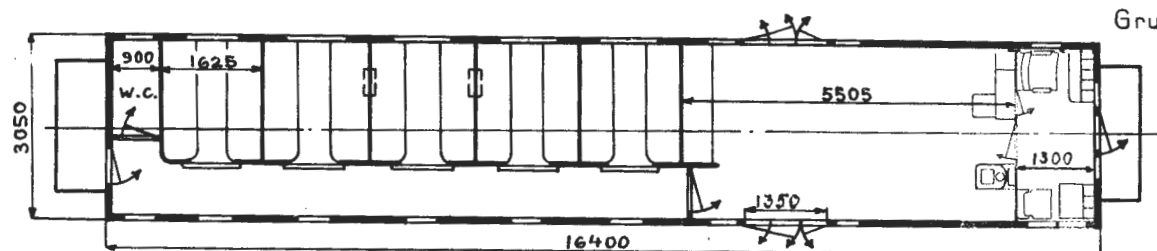

Grunnriss 2

Hovedt. B.112

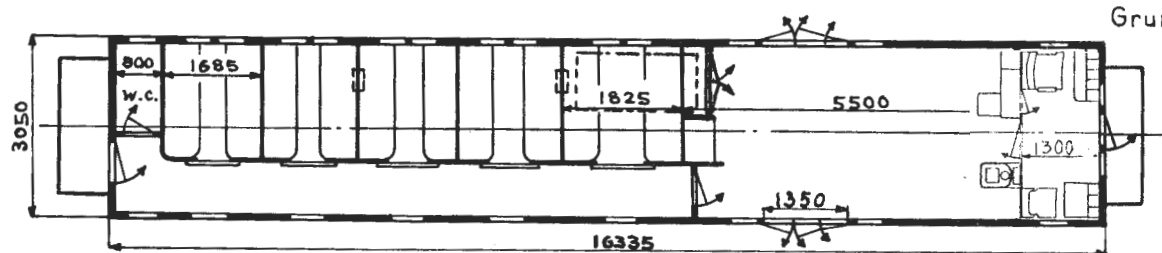

Vogn nr.	Distriktsmerke	Fabrikant	Byggear	Omtr. vognvekt i tonn	Sittepl. 2.klasse	Reisegods, last i tonn	Grunnriss	El. varme i kW	Vognutstyr (se side 6)	Merknad
94	0	Skb	01	27,5	40	2,0	2		1H.3.5.7.8.11.39a	
806	H	Str	"	27,0	"	"	1		1H.3.6.7.8.11	
807	"	"	"	26,5	"	"	"		1H.3.6.7.8.11	

BFo2c

TYPE 2

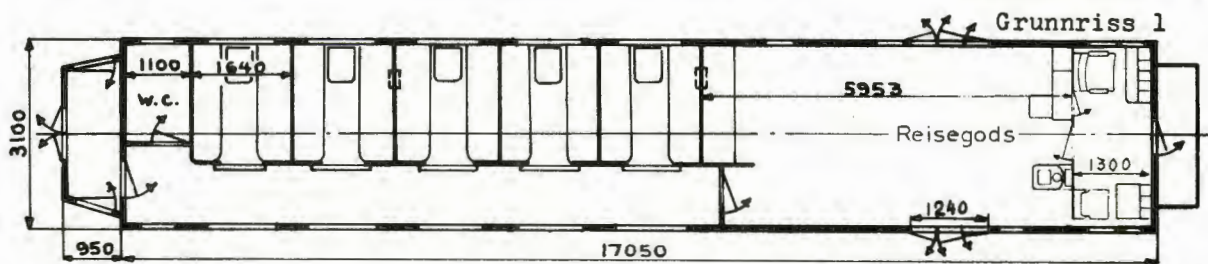
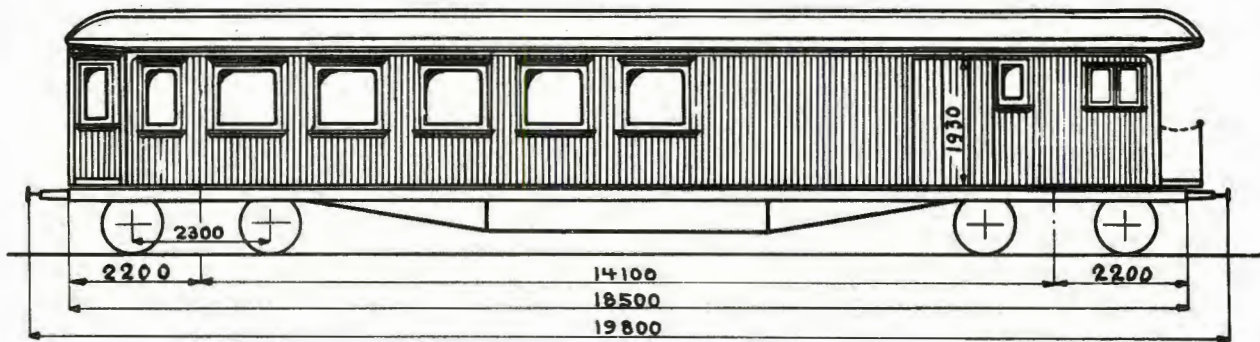

Hovedt. 2126

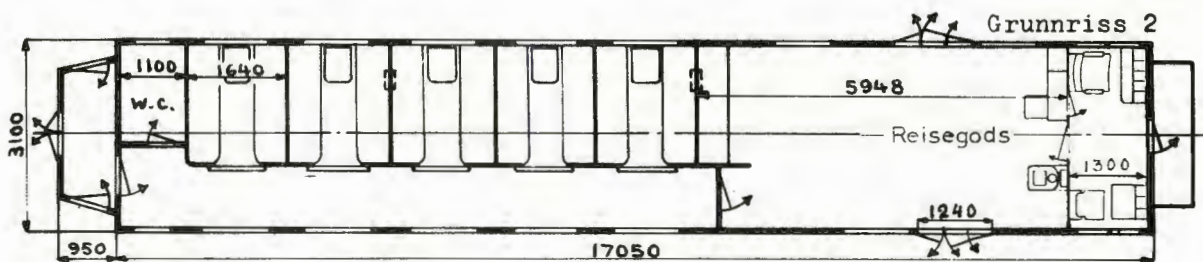

Hovedt. 2126
3052

Vogn nr.	Distriktsmerke	Fabrikant	Byggeår	Omr. vognvekt i tonn	Sittepl. 2.klasse	Reisegods, last i tonn	Grunnriss	El. varme i kW	Vognutstyr (se side 6)	Merknad
97	0	Str	23	32,5	40	4,0	2		1H.3.5.7.8.11.39a	
98	"	"	"	33,0	"	"	"		1H.3.5.7.8.11.28.39a	
120	"	"	28	31,5	"	"	"		1H.3.5.8.11.39a	1)
121	"	"	"	30,5	"	"	"		1H.3.5.7.8.11.28.39a	
184	"	"	17	31,0	"	"	1		1H.3.5.8.11.28.39a	
185	"	"	21	30,0	"	"	"		1H.3.5.7.8.11.28.39a	
188	"	"	25	30,5	"	"	2		1H.3.5.8.11.39a	2)
296	"	"	16	31,0	"	"	1		1H.3.8.11.39a	2)
647	D	"	27	"	"	"	2		1H.3.5.7.8.11.28.39a	
648	"	"	"	"	"	"	"		1H.3.5.7.8.11.28.39a	
852	"	"	21	33,0	"	"	1		1H.3.5.8.11.28.39a	

- 1) Kond.rom utv. til 1800 mm
 2) Sykekupé med inng. fra reiseg.
 Trykk nr. 751 1.7.58

Vogn n.:	Distriktsmerke	Fabrikant	Byggear	Omr. vognvekt i tonn	Sittepl. 2.klasse	Reise gods, last i tonn	Grunnriss	El. varme i kW	Vognutstyr (se side 6)	Merknad
647	D	Str	27	31,0	40	4,0	2		1H.3.5.7.8.11.28.39a	
648	"	"	"	"	"	"	"		1H.3.5.7.8.11.28.39a	
120	0	"	28	31,5	"	"	"		1H.3.5.7.8.11	Kond.r. utv. til 1000 mm
121	"	"	"	30,5	"	"	"		1H.3.5.7.8.11.28.39a	

BFo2c

TYPE 3

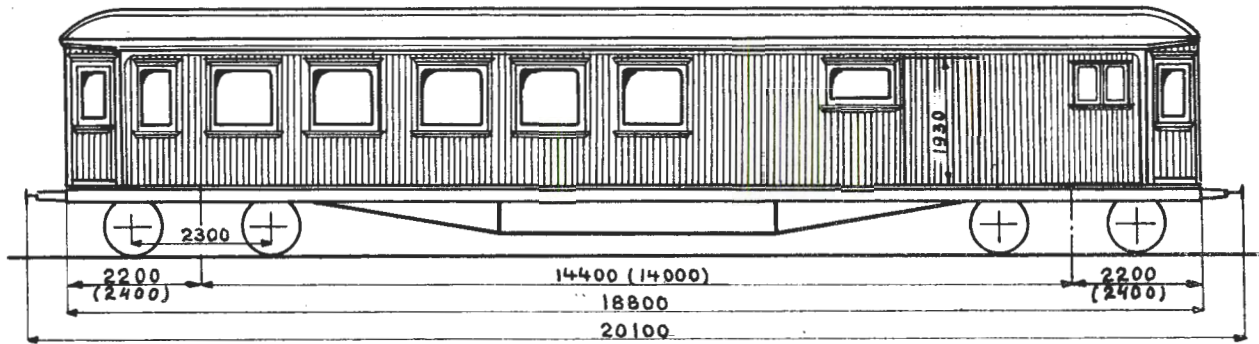

Mål i () gjelder for grunnriss 2

Grunnriss 1

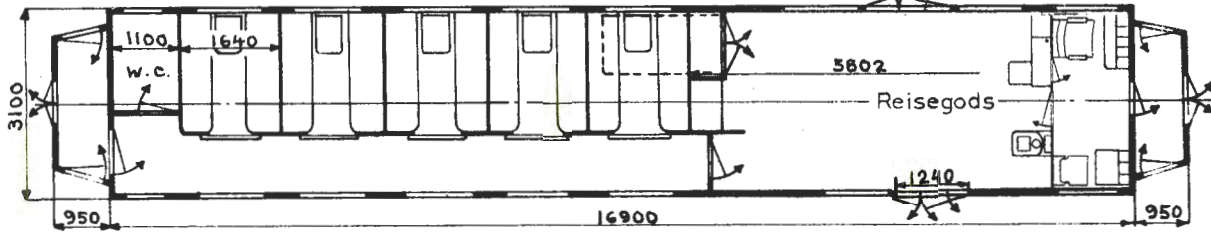

Hovedt. 3039

Grunnriss 2

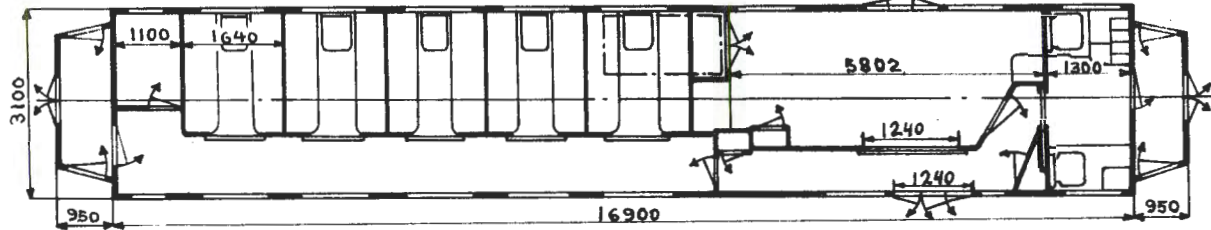

Hovedt. 3231

Vogn nr.	Distriktsmerke	Fabrikant	Byggear	Omtr. vognvekt i tonn	Sittepl. 2.klasse	Reisegods, last i tonn	Grunnriss	El. varme i kW	Vognutstyr (se side 6)	Merknad
122	0	Str	28	33,5	40	4,0	1		LKK.3.5.8.11.28.39a	
123	"	"	"	32,5	"	"	"		LKK.3.5.8.11.28.35.39a	
213	"	Skb	30	"	"	2,5	2		LKK.3.5.8.11.28.35.39a	
214	"	"	"	33,5	"	"	"		LKK.3.5.8.11.28.35.39a	
215	"	"	"	34,0	"	"	"		LKK.3.5.8.11.28.35.39a	
216	"	"	"	32,0	"	"	"		LKK.3.5.8.11.28.39a	

Vogn nr.	Distriktsmerke	Fabrikant	Byggeår	Omr. vognvekt i tonn	Sittepl. 2.klasse	Reisegods, last i tonn	Grunnriss	El. varme i kW	Vognutstyr (se side 6)	Merknad
879	0	Str	17	32,0	40	4,0	1		1KK.3.5.8.12.39a	
882	"	"	16	"	"	"	"		1KK.3.5.8.11.28.39a	2)
888	"	Skb	"	"	"	"	"		1H.3.5.7.8.11.39a	
18015	D	"	15	33,0	"	"	"		1H.3.5.7.8.11.28.39a	3)

2) Sykekupé med inng. fra reisegodsrom

3) Utvidet forgang

Trykk nr. 751 1.7.57

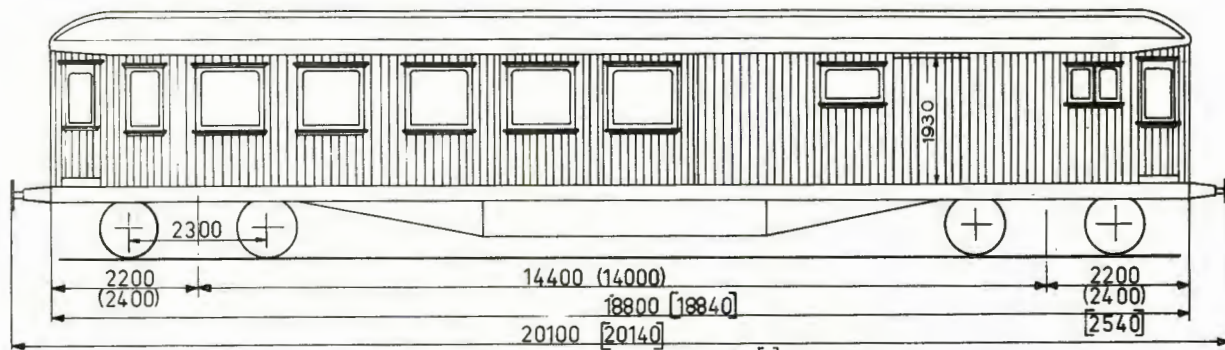

Mål i () gjelder for grunnriss. Mål i [] gjelder for grunnriss 3

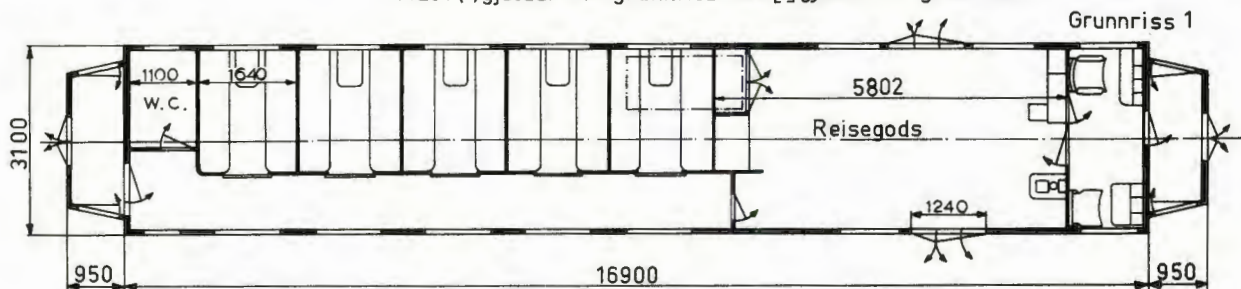

Hovedt. 3039

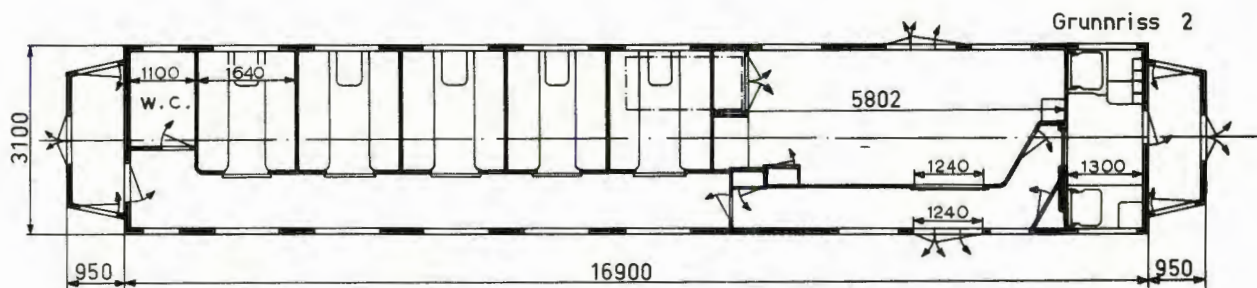

Hovedt. 3231

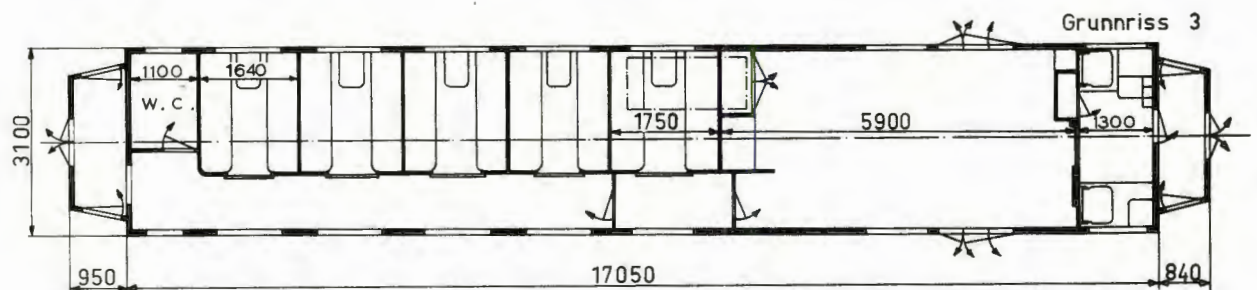

Hovedt. 1841

Vogn nr.	Distriktsmerke	Fabrikant	Byggeår	Omtr. vognvekt i tonn	Sittepl. 2 klasse	Reisegods last i tonn	Grunnriss	El.varme i kW	Vognutstyr (se side 6)	Merknad
122	O	Str	28	33,5	4,0	4,0	1		1KK.3.5.8.11.28.39a	1)
123	"	"	"	32,5	"	"	"		1KK.3.5.8.11.28.35.39a	
213	"	Skb	30	"	"	2,5	2		1KK.3.5.8.11.28.35.39a	
214	"	"	"	33,5	"	"	"		1KK.3.5.8.11.28.35.39a	
215	"	"	"	34,0	"	"	"		1KK.3.5.8.11.28.35.39a	
216	"	"	"	32,0	"	"	"		1KK.3.5.8.11.28.39a	
799	H	Str	24	30,5	"	4,0	3		1H.3.5.8.11.28.39a	

1) Plattf. sidedører ved 2kl. avd. slår utover
Trykk nr. 751 1.7.58

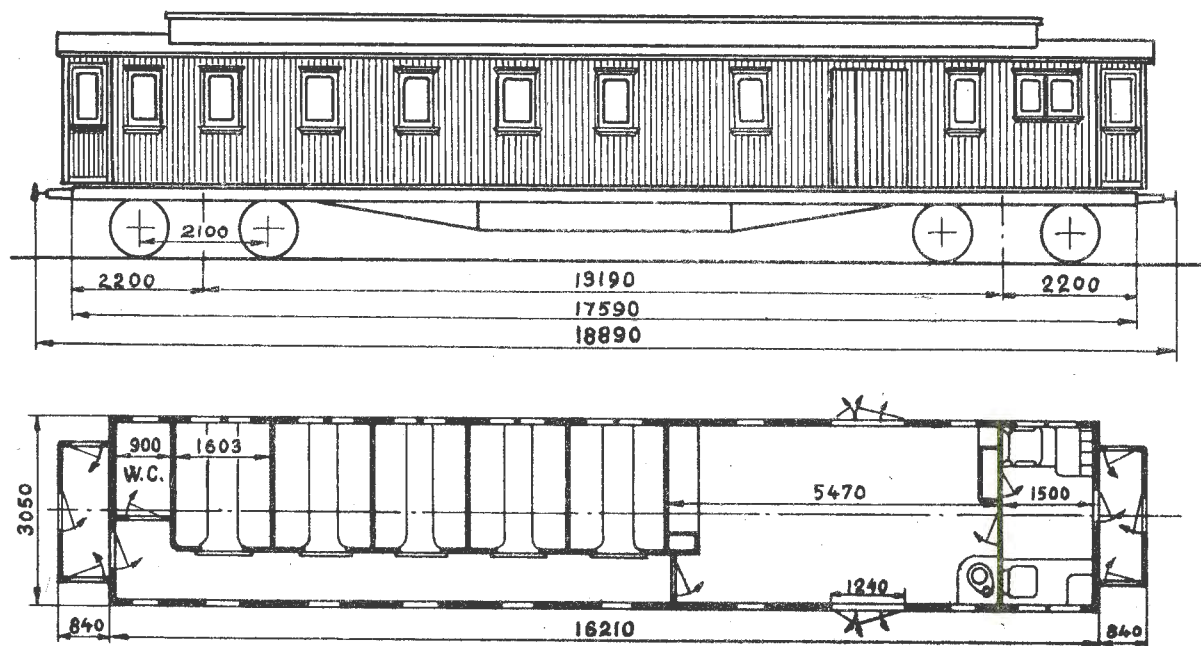
Oppr. hovedt. 469¹⁾

Vogn nr.	Distriktsmerke	Fabrikant	Byggear	Omtr. vognvekt i tonn	Sittepl. 2. klasse	Reisegods, last i tonn	Grunnriss	El. varme i kW	Vognutstyr (se side 6)	Merknad
845	T	Skb	01	26,0	40	2,0			1H.3.5.8.11	

1) Forandr. etter skisse 844
Trykk nr. 751 1.7.56

BFo2c

TYPE 5

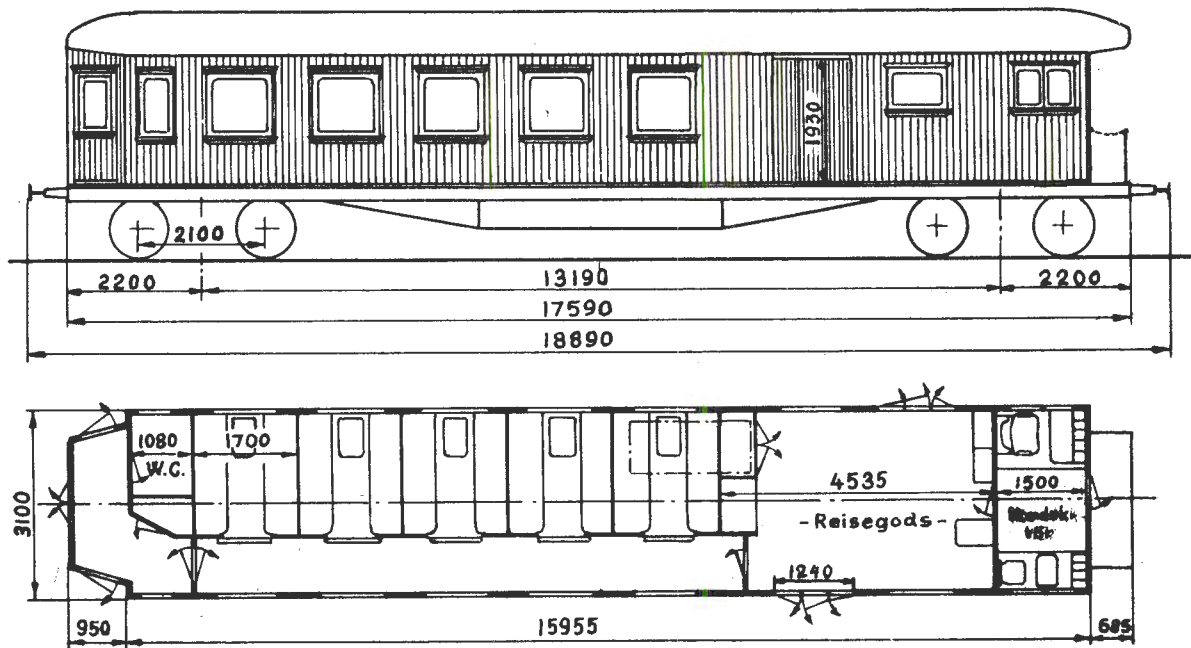

Oppr. hovedt. 468¹⁾
Som Zo type 2

Vogn nr.	Distriktsmerke	Fabrikant	Byggear	Omr. vognvekt i tonn	Sittepl. 2.klasse	Reisegods, last i tonn	Grunnriss	El. varme i kW	Vognutstyr (se side 6)	Merknad
906	D	Skb	00	28,0	40	2,0			1H.3.5.8.11.28.39a	} Nye vognkasser i 1949
245	"	SWf	01	"	"	"			1H.3.5.8.11.28.39a	
246	"	"	"	28,5	"	"			1H.3.5.8.11.28.39a	
724	"	"	02	28,0	"	"			1H.3.5.8.11.28.39a	

1) Forandr. etter tegn. 6074

BFo2d

TYPE 1.
Stålvogner

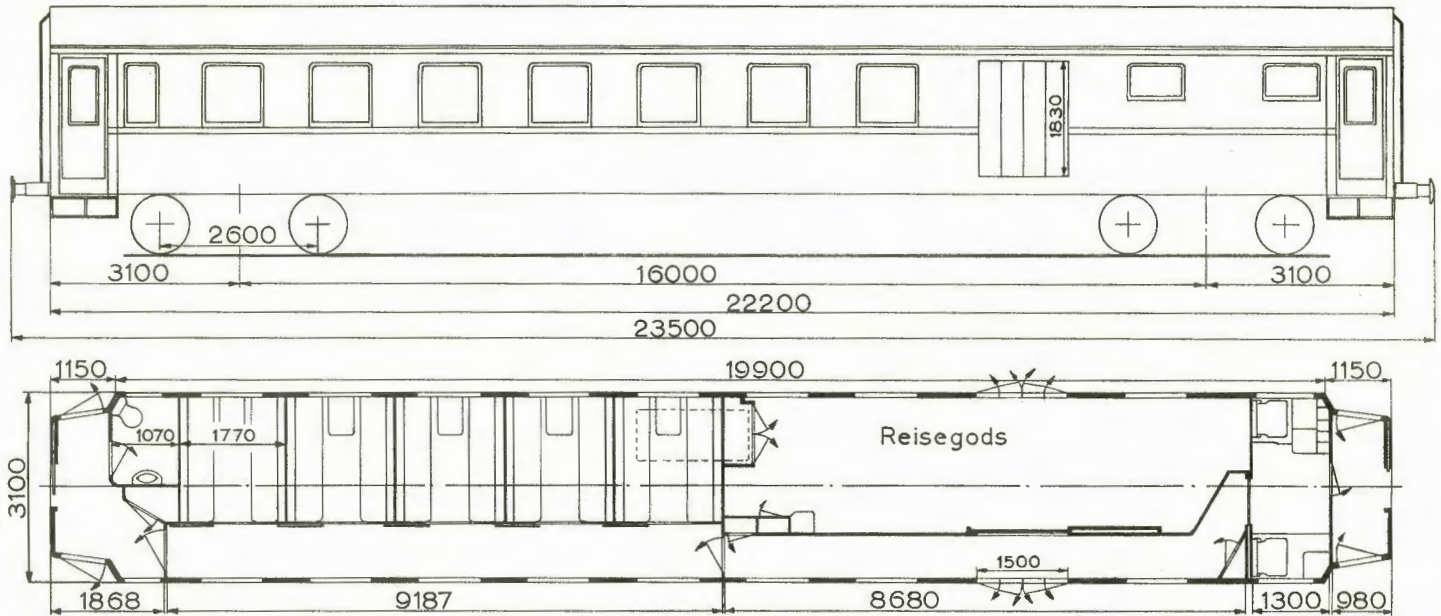

Hovedt. 4100

Vogn nr.	Distriktsmerke	Fabrikant	Byggear	Omtr. vognvekt i tonn	Sittepl. 2. klasse	Reisegods, last i tonn	Grunnriss	El. varme i kW	Vognutstyr (se side 6)	Merknad
21501	O	Skb	38	35,0	40	4,0		23	1H. 3. 5. 11. 28. 39a.	
21502	=	"	"	"	"	"		"	1H. 3. 5. 11. 28. 39a.	
21503	=	"	"	"	"	"		"	1H. 3. 5. 11. 28. 39a.	

BFo2d

TYPE 2
Stålvogner

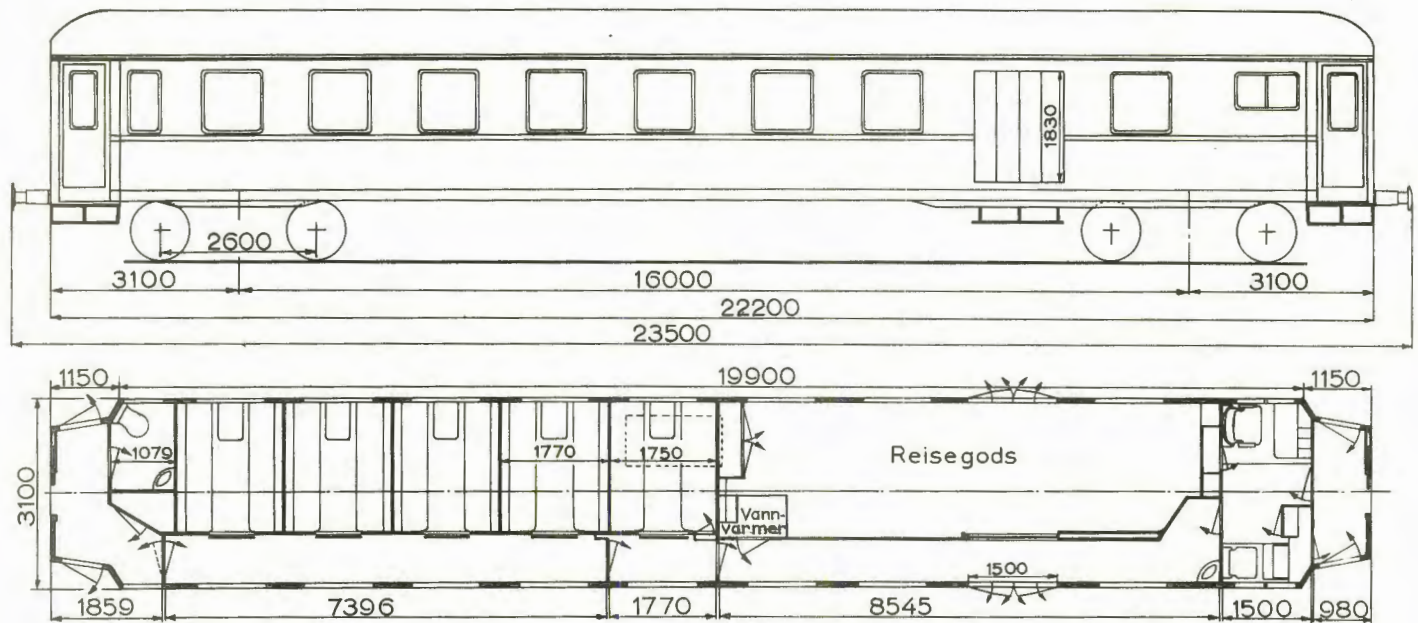

Hovedt. 6490

Vogn nr.	Distriktsmerke	Fabrikant	Byggeår	Omtr. vognvekt i tonn	Sittepl. 2. klasse	Reisegods, last i tonn	Grunnriss	El. varme i kW	Vognutstyr (se side 6)	Merknad
21504	O	Str	55	38,0	40	4,0	28	1H. 3. 5. 11. 28. 39a.		
21505	"	"	"	38,5	"	"	"	1H. 3. 5. 11. 28. 39a.		
21506	"	"	"	38,0	"	"	"	1H. 3. 5. 11. 28. 39a.		
21507	"	"	"	"	"	"	"	1H. 3. 5. 11. 28. 39a.		
21508	"	"	"	"	"	"	"	1H. 3. 5. 11. 28. 39a.		
21509	"	"	"	38,5	"	"	"	1Hs. 3. 5. 11. 28. 39a.		
21510	"	"	"	38,0	"	"	"	1Hs. 3. 5. 11. 28. 39a.		
21511	D	"	"	37,0	"	"	30	1Hs. 3. 12. 28. 39a.		
21512	"	"	"	"	"	"	"	1Hs. 3. 12. 28. 39a.		
21513	"	"	"	"	"	"	"	1Hs. 3. 12. 23. 39a.		
21514	"	"	"	"	"	"	"	1Hs. 3. 12. 28. 39a.		

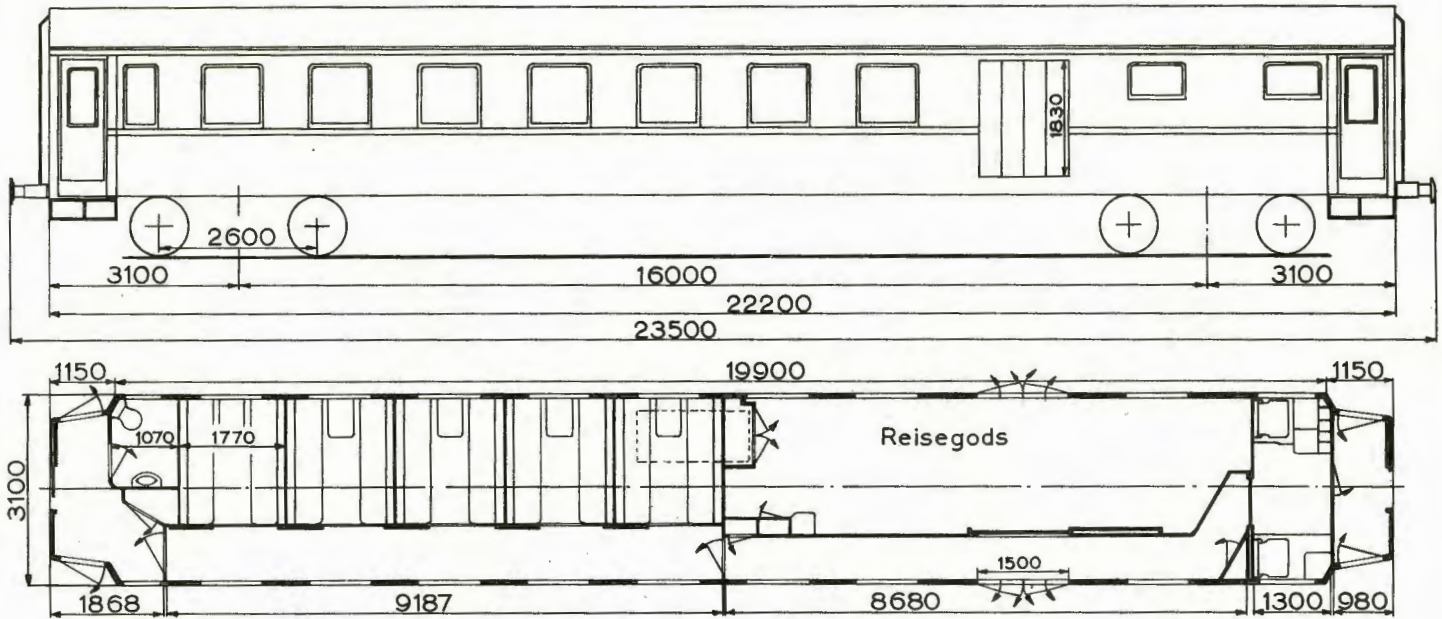

Hovedt. 4100

Vogn nr.	Distriktsmerke	Fabrikant	Byggeår	Omr. vognvekt i tonn	Sittepl. 2.klasse	Reisegods, last i tonn	Grunnriss	Ei.varme i kW	Vognutstyr (se side 6)	Merknad
21501	O	Skb	38	35,0	40	4,0	23	1H. 3. 5. 11. 28. 39a.		
21502	"	"	"	37,0	"	"	"	1H. 3. 5. 11. 28. 39a.		
21503	"	"	"	35,0	"	"	"	1H. 3. 5. 11. 28. 39a.		

BFo2d

TYPE 2
Stålvogner

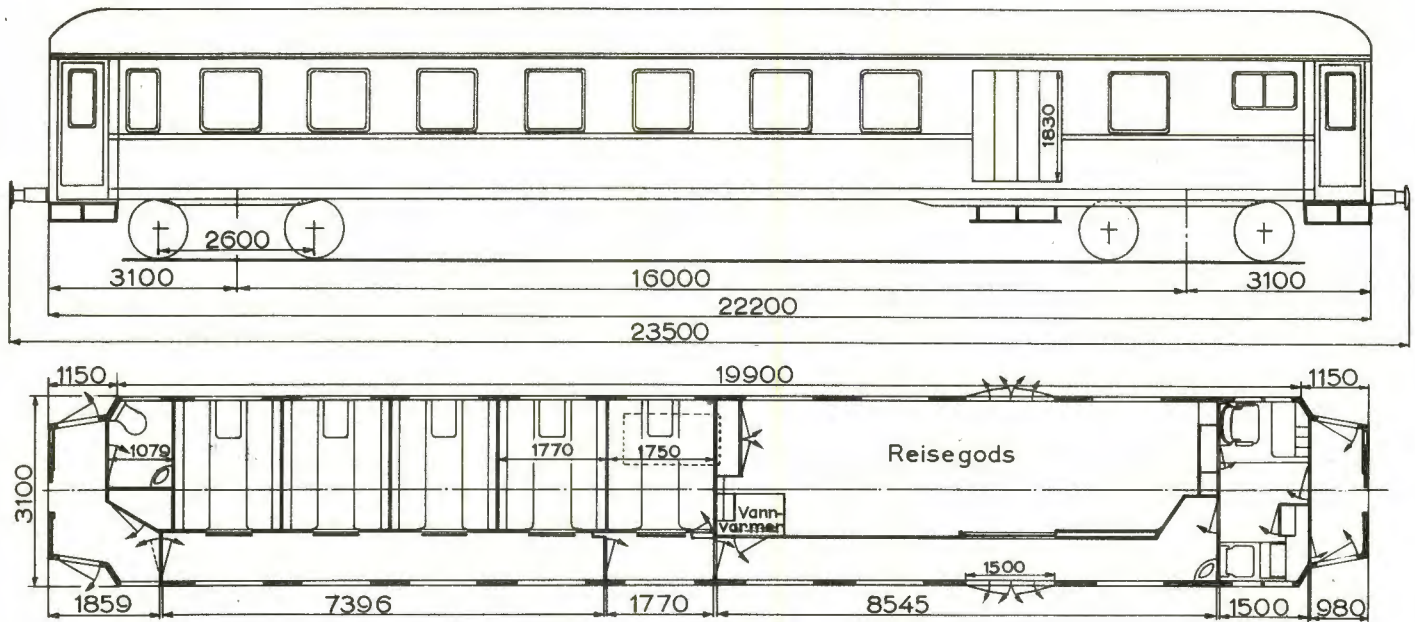

Hovedt. 6490

Vogn nr.	Distriktsmerke	Fabrikant	Byggear	Omtr. vognvekt i tonn	Sittepl. 2.klasse	Reisegods, last i tonn	Grunnriss	El. varme i kW	Vognutstyr (se side 6)	Merknad
21504	O	Str	55	38,0	40	4,0	28	1H. 3. 5. 11. 28. 39a.		
21505	"	"	"	38,5	"	"	"	1H. 3. 5. 11. 28. 39a.		
21506	"	"	"	38,0	"	"	"	1H. 3. 5. 11. 28. 39a.		
21507	"	"	"	"	"	"	"	1H. 3. 5. 11. 28. 39a.		
21508	"	"	"	"	"	"	"	1H. 3. 5. 11. 28. 39a.		
21509	"	"	"	38,5	"	"	"	1Hs. 3. 5. 11. 28. 39a.		
21510	"	"	"	38,0	"	"	"	1Hs. 3. 5. 11. 28. 39a.		
21511	D	"	"	37,0	"	"	30	1Hs. 3. 12. 28. 39a.		
21512	"	"	"	"	"	"	"	1Hs. 3. 12. 28. 39a.		
21513	"	"	"	"	"	"	"	1Hs. 3. 12. 28. 39a.		
21514	"	"	"	"	"	"	"	1Hs. 3. 12. 28. 39a.		

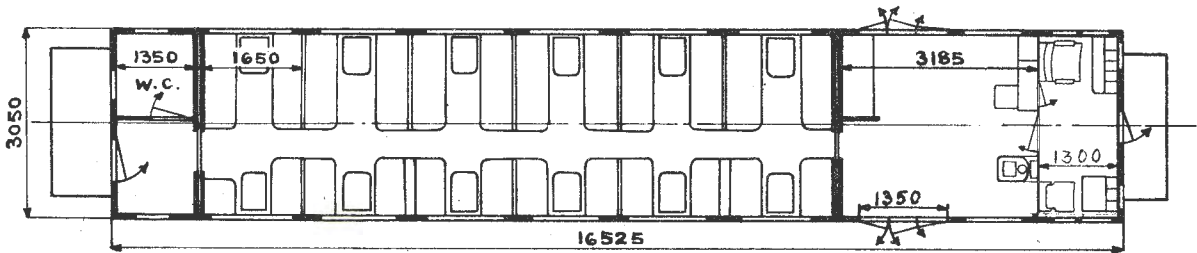
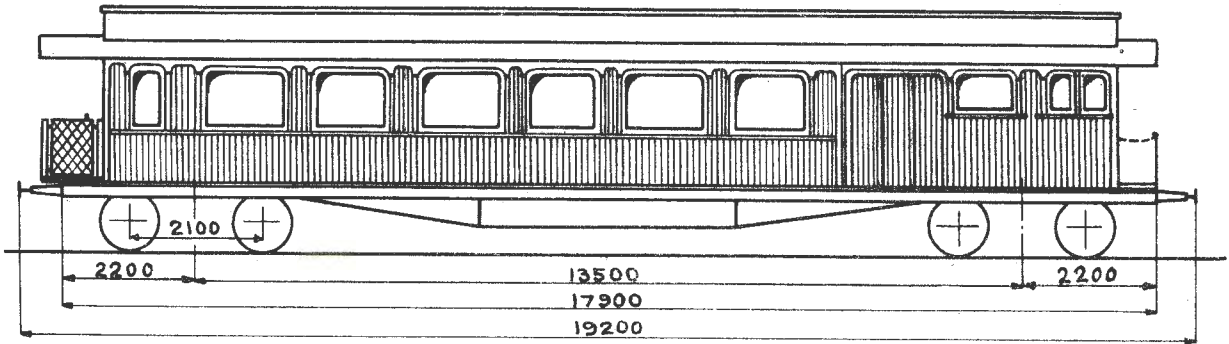

Hovedt. B. 241

Vogn n.	Distriktsmerke	Fabrikant	Byggear	Omtr. vognvekt i tonn	Sittepl. 2.klasse	Reisegods, last i tonn	Grunnriss	El.varme i kW	Vognutstyr (se side 6)	Merknad
96	0	Str	11	29,0	59	1,0			1H.3.5.8.11.39a	

BFo3a

TYPE 2

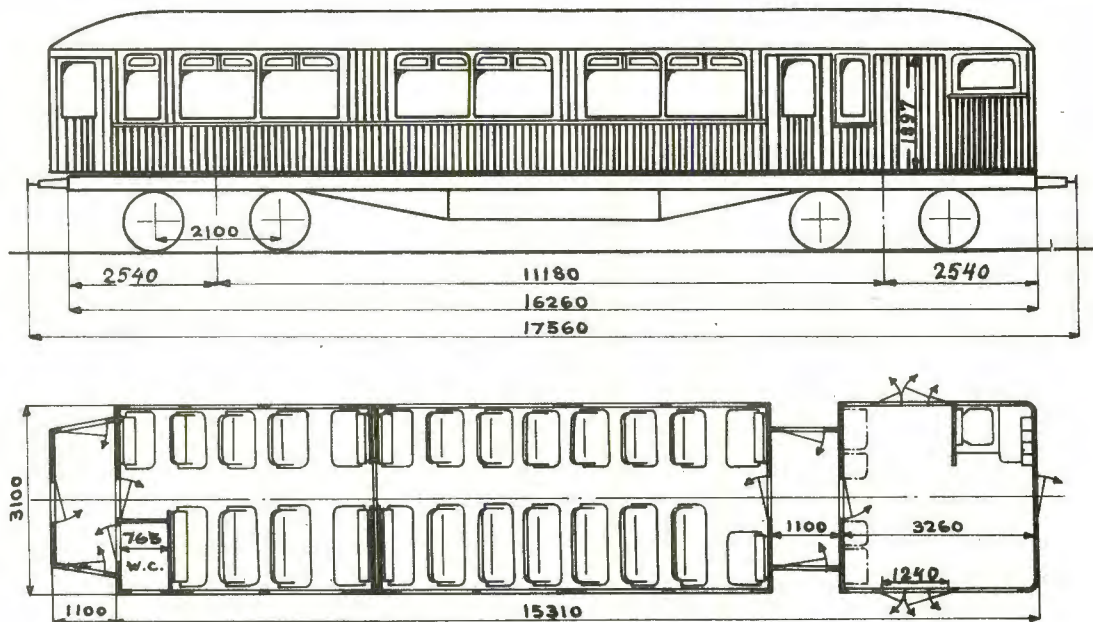

Oppr. hovedt. B. 65¹⁾

Vogn nr.	Distriktsmerke	Fabrikant	Byggeår	Omtr. vognvekt i tonn	Sittepl. 2. klasse	Reisegods, last i tonn	Grunnriss	El. varme i kW	Vognutstyr (se side 6)	Merknad
67	T	Str	99	24,0	61	1,0			1H.3.5.11.41	} Tilhenger for motorvogn
68	"	"	"	"	"	"			1H.3.11.41	
69	"	"	"	"	"	"			1H.3.5.11.41	

1) Ny vognkasse i 1933 etter tegn. 3405
Trykk nr. 751 1.7.56

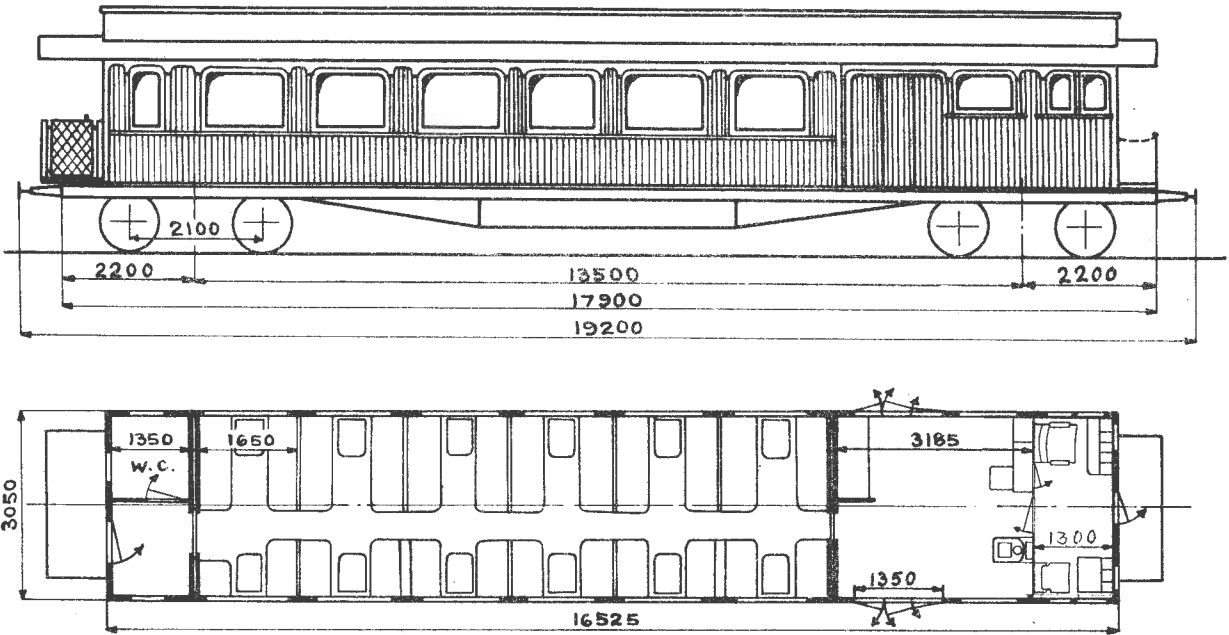

Hovedt. B. 241

Vogn nr.	Distriktsmerke	Fabrikant	Byggear	Omtr. vognvekt i tonn	Sittepl. 2.klasse	Reisegods, last i tonn	Grunnriss	El. varme i kW	Vognutstyr (se side 6)	Merknad
96	0	Str	11	29,0	59	1,0			1H.3.5.8.11.39a	

BFo3a

TYPE 2

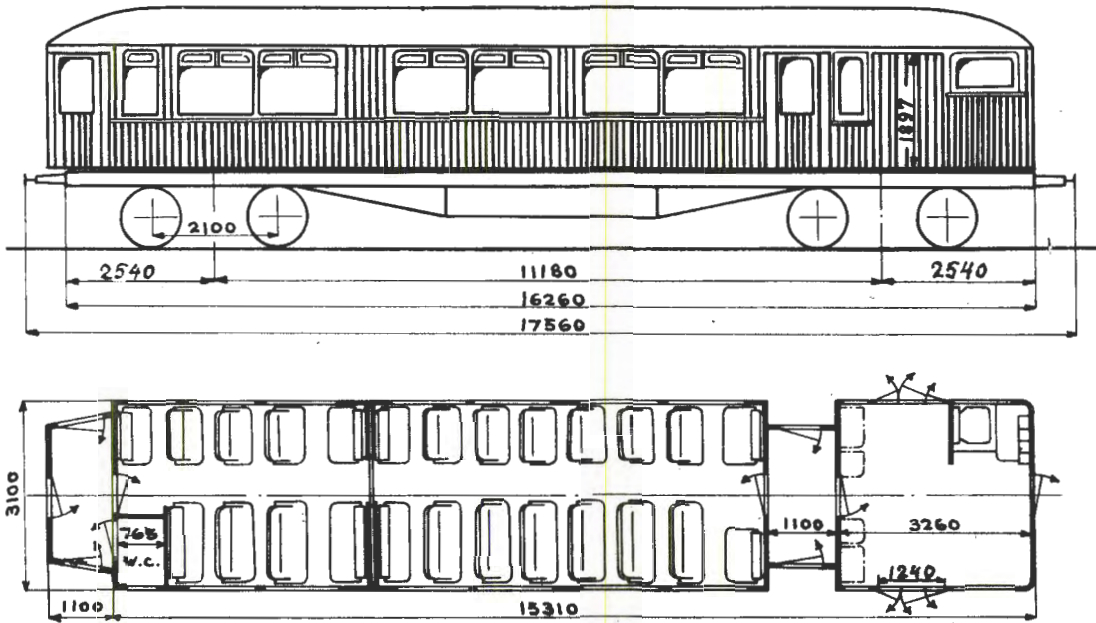

Oppr. hovedt. B. 65¹⁾

Vogn nr.	Distriktsmerke	Fabrikant	Byggear	Omtr. vognvekt i tonn	Sittepl. 2.klasse	Reisegods, last i tonn	Grunnriss	El. varme i kW	Vognutstyr (se side 6)	Merknad
67	T	Str	99	24,0	61	1,0			1H.3.5.11.41	} Tilhenger for motorvogn
68	"	"	"	"	"	"			1H.3.11.41	
69	"	"	"	"	"	"			1H.3.5.11.41	

1) Ny vognkasse i 1933 etter tegn. 3405
Trykk nr. 751 1.7.56

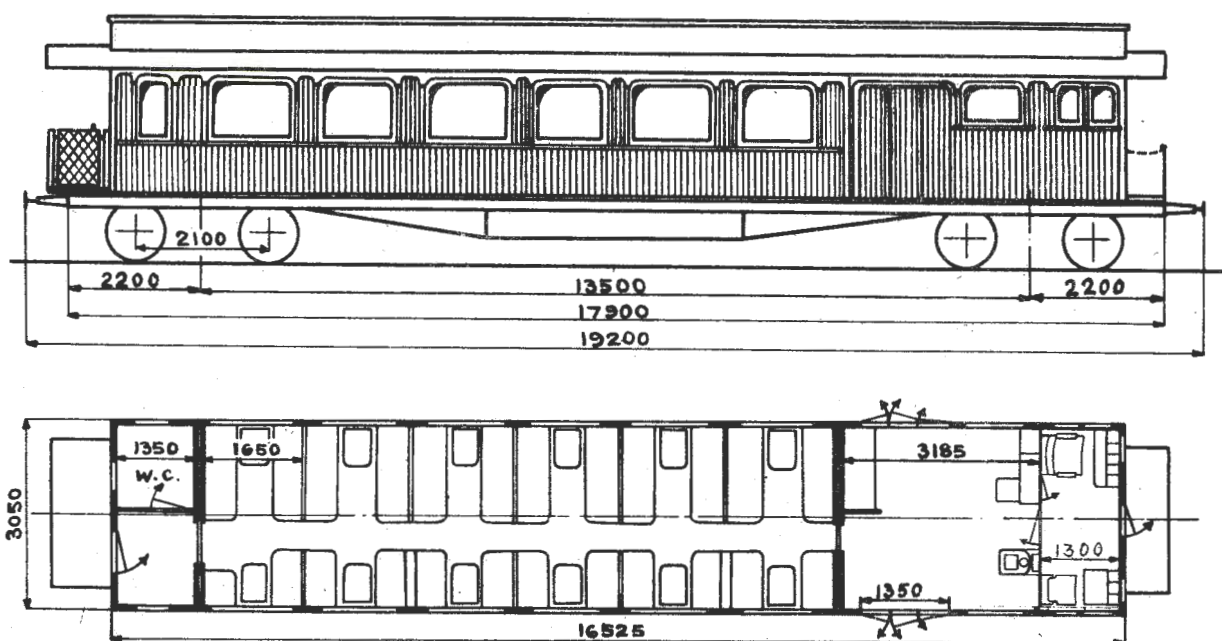

Hovedt. B. 241

Vogn nr.	Distriktsmerke	Fabrikant	Byggeår	Omr. vognvekt i tonn	Sittepl. 2.klasse	Reisegods, last i tonn	Grunnriss	El.varme i kW	Vognutstyr (se side 6)	Merknad
96	0	Str	11	29,0	59	1,0			1H.3.5.8.11.39a	

BFo3a

TYPE 2

Trevogner med plateledning

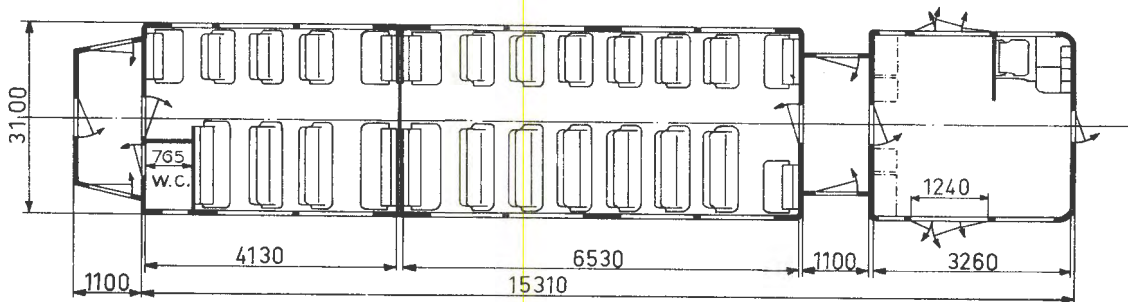
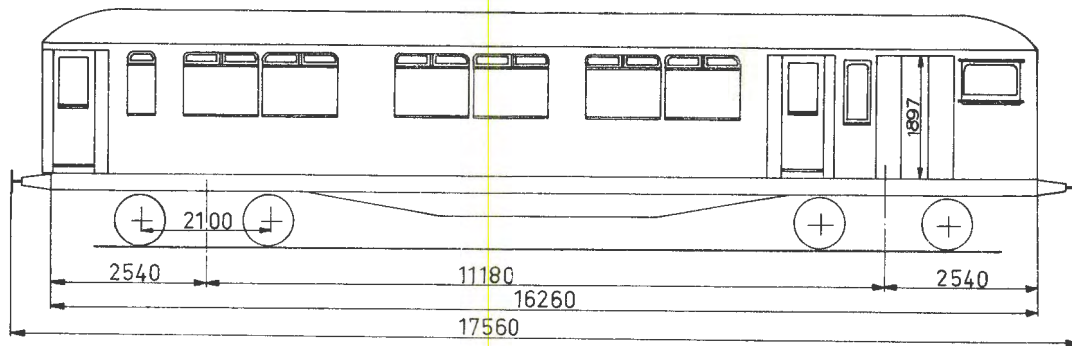

Oppr.hovedt .B.65¹⁾

Vogn nr.	Distriktsmerke	Fabrikant	Byggeår	Omr. vognvekt i tonn	Sittepl. 2.klasse	Reisegods, last i tonn	Grunnriss	El.varme i kW	Vognutstyr (se side 6)	Merknad
67	T	Str	99	24,0	61	1,0			1H.3.5.11.41	} Tilhenger for motorvogn
68	"	"	"	"	"	"			1H.3.11.41	
69	"	"	"	"	"	"			1H.3.5.11.41	

1) Ny vognkasse i 1933 etter tegn. 3405

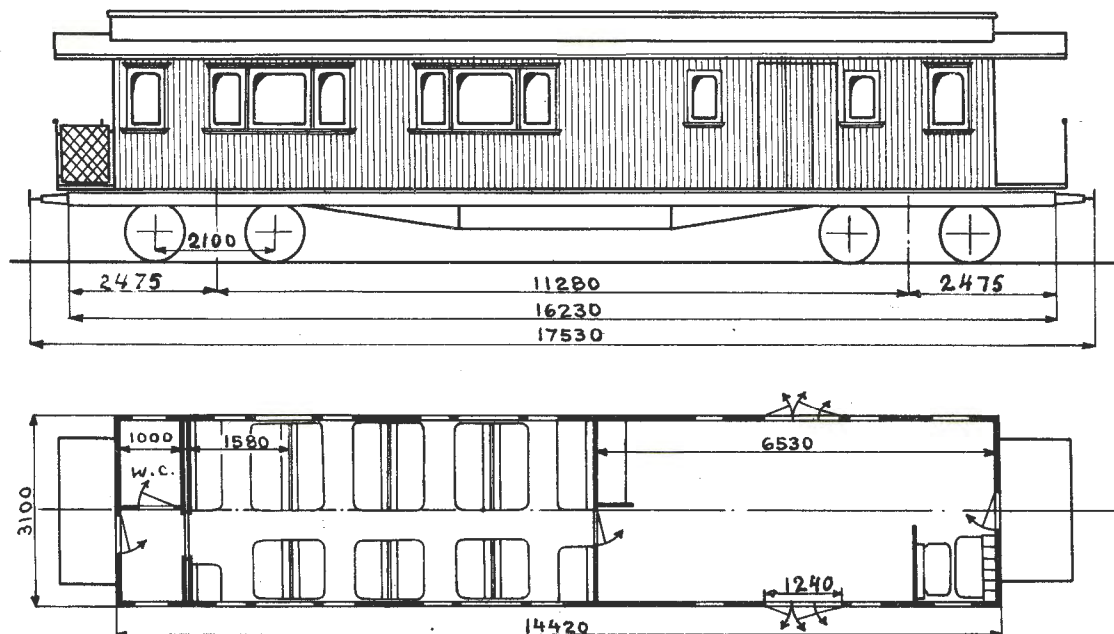
Oppr. hovedt. 91¹⁾

Vogn nr.	Distriktsmerke	Fabrikant	Byggeår	Omr. vognvekt i tonn	Sittepl. 2.klasse	Reisegods, last i tonn	Grunnriss	El. varme i kW	Vognutstyr (se side 6)	Merknad
325	0	Str	93	26,0	39				1H.3.5.7.8.11	

BFo3b

TYPE 2

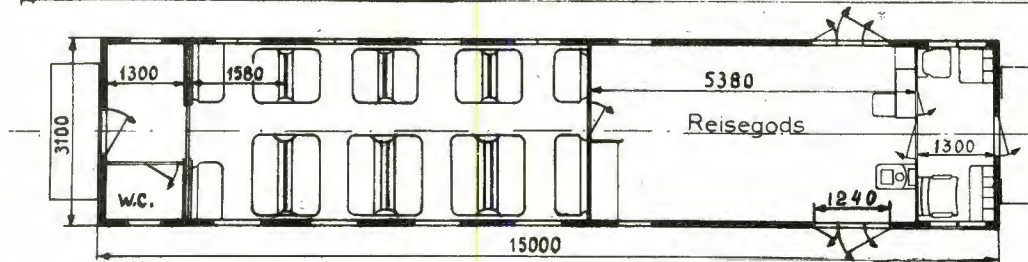
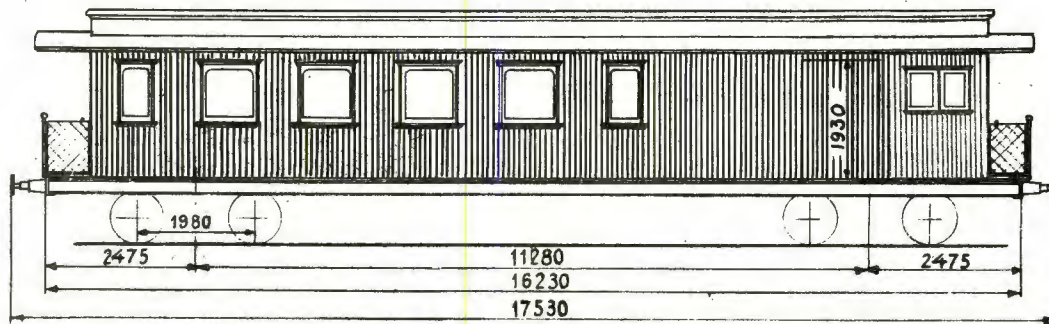

Oppr. hovedt. 220¹⁾

Vogn nr.	Distriktsmerke	Fabrikant	Byggeår	Omr. vognvekt i tonn	Sitte pl. 2.klasse	Reisegods, last i tonn	Grunnriss	El. varme i kW	Vognutstyr (se side 6)	Merknad
479	0	Skb	93	24,0	41				1H.3.5.7.8.10	

1) Forandr. som typetegn. viser i 1952
Trykk nr. 751 1.7.56

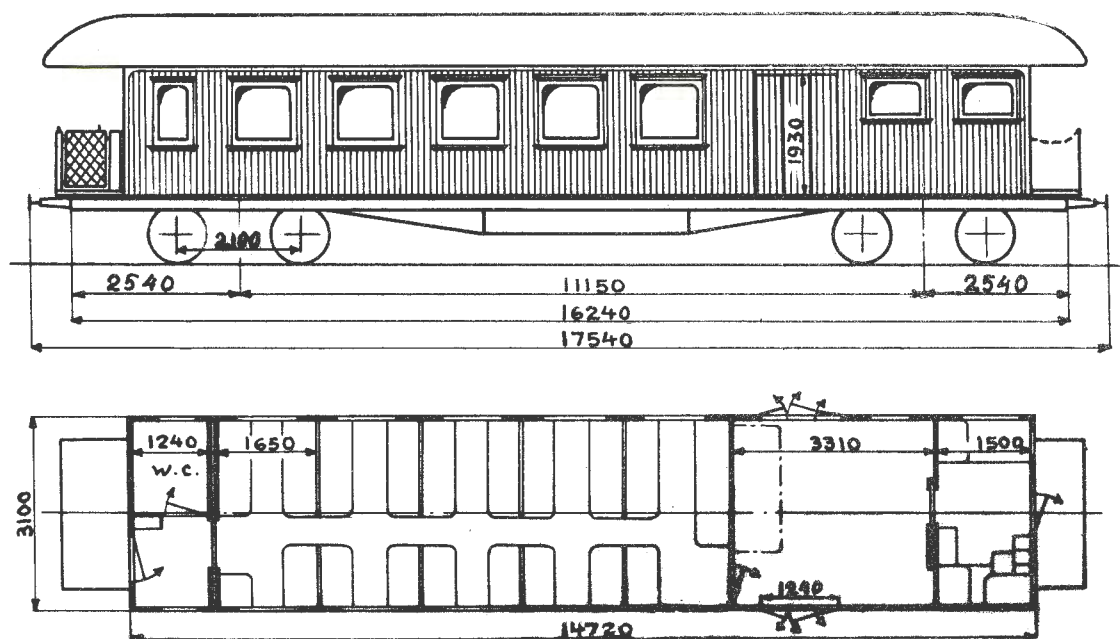

Hovedt. B. 529

Vogn nr.	Distriktsmerke	Fabrikant	Byggeår	Omt. vognvekt i tonn	Sittepl. 2.klasse	Reisegods, last i tonn	Grunnriss	El. varme i kW	Vognutstyr (se side 6)	Merknad
9	0	Skb	97	28,0	48	2,0			1H.3.5.11.39a	
10	"	"	"	26,0	"	1,5			1H.3.5.8.10.39a	Benk for sykebare

BFo3b

TYPE 4

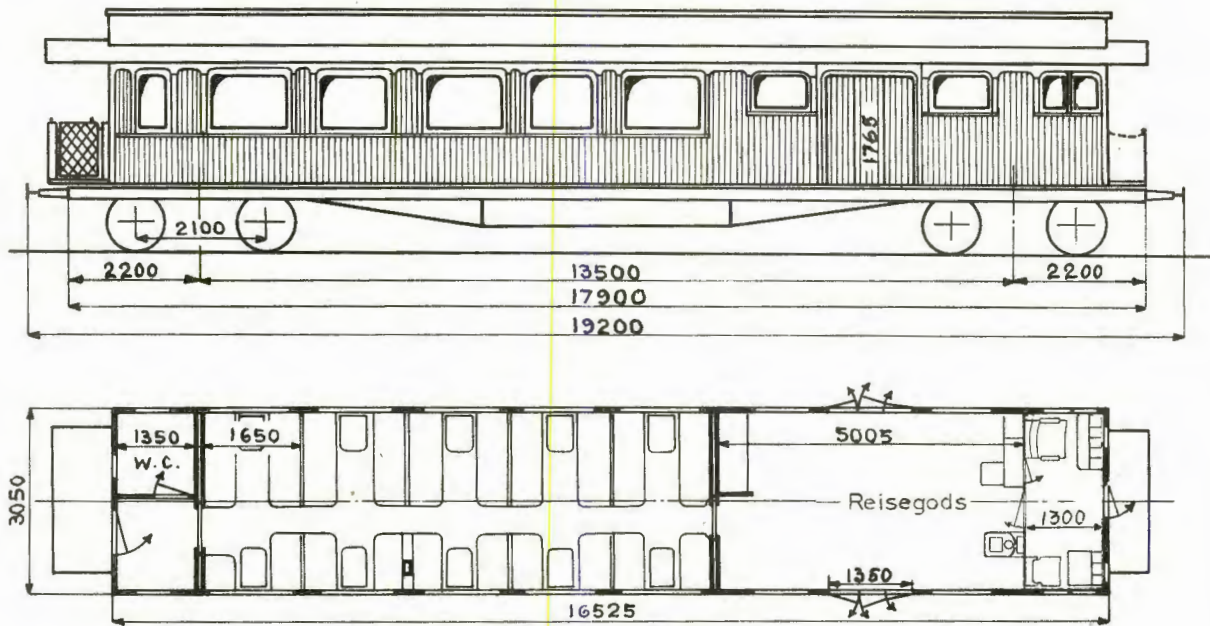

Hovedt. B. 240

Vogn nr.	Distriktsmerke	Fabrikant	Byggeår	Omtr. vognvekt i tonn	Sittepl. 2.klasse	Reisegods, last i tonn	Grunnriss	El. varme i kW	Vognutstyr (se side 6)	Merknad
95	0	Str	10	30,5	49	2,0			1H.3.5.7.8.11.39a	

BFo3b

TYPE 5
Lettmetallvogn

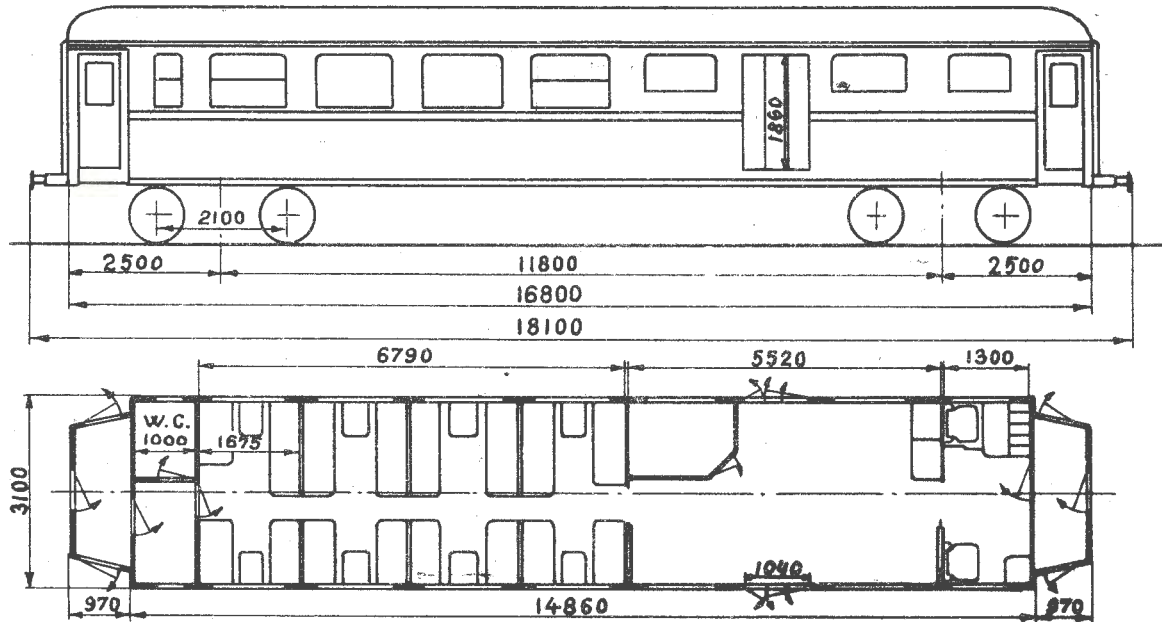

Hovedt. 5191

Vogn nr.	Distriktsmerke	Fabrikant	Byggeår	Omtr. vognvekt i tonn	Sittepl. 2.klasse	Reisegods, last i tonn	Grunnriss	El. varme i kW	Vognutstyr (se side 6)	Merknad
18169	B	Str	47	20,5	39				1H.3.6.12 39a	
18170	"	"	"	20,0	"				1H.3.6.12.39a	

BFo3b

TYPE 6

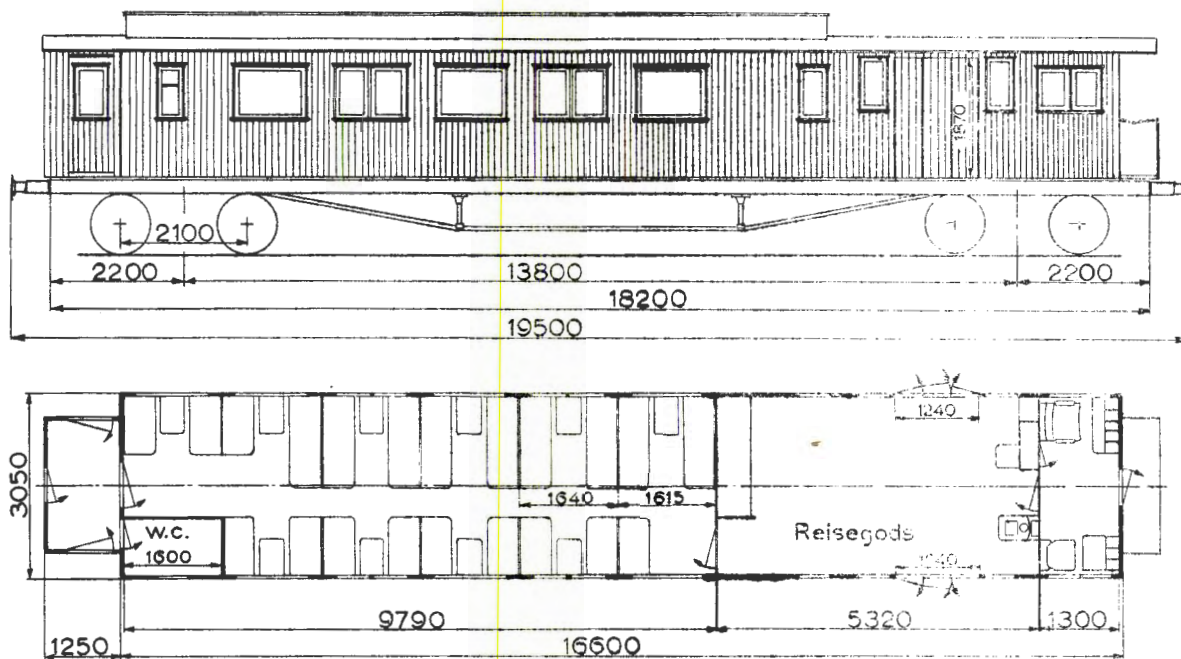

Oppr hovedt. 689

Vogn n ^o .	Distriktsmerke	Fabrikant	Byggeår	Omtr. vognvekt i tonn	Sittepl. 2.klasse	Reisegods, last i tonn	Grunnriss	El. varme i kW	Vognutstyr (se side 6)	Merknad
971	B	Skb	04	270	51	2,0			1H. 3. 5 8. 11. 39.	
972	"	"	"	260	"	2,5			1H. 3. 5 8. 11. 39.	

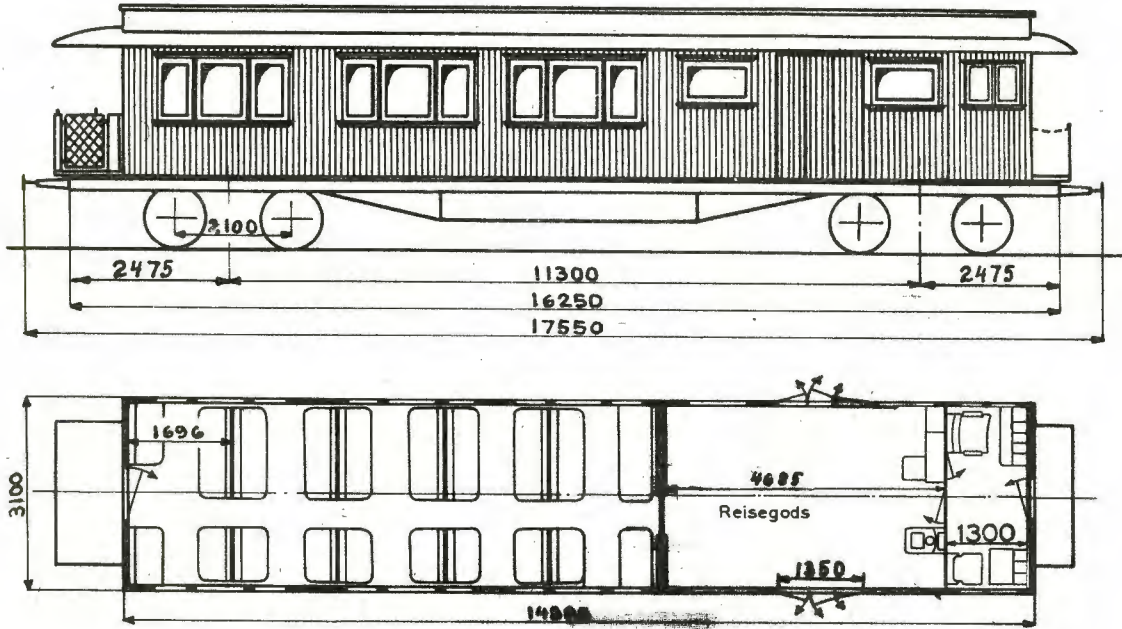

Hovedt. B. 349

Vogn nr.	Distriktsmerke	Fabrikant	Byggeår	Omtr. vognvekt i tonn	Sittepl. 2.klasse	Reisegods, last i tonn	Grunnriss	El. varme i kW	Vognutstyr (se side 6)	Merknad
73	0	Skb	90	27,0	49				1H.3.5.11.39a	Ny vognkasse i 1915

BFo4a

TYPE 2

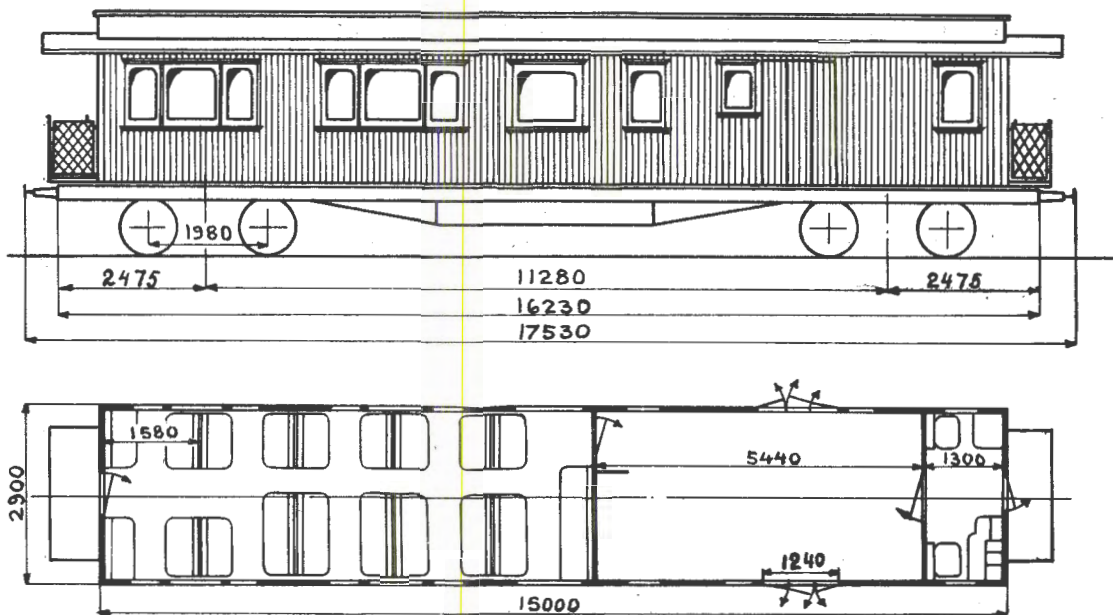

Oppr. hovedt. 188¹⁾

Vogn nr.	Distriktsmerke	Fabrikant	Byggeår	Omr. vognvekt i tonn	Sittepl. 2.klasse	Reisegods, last i tonn	Grunnriss	El. varme i kW	Vognutstyr (se side 6)	Merknad
490	K	Str	93	24,0	46				1H.3.5.10	

1) Forandr. etter O.d. tegn. 1224
Trykk nr. 751 1.7.56

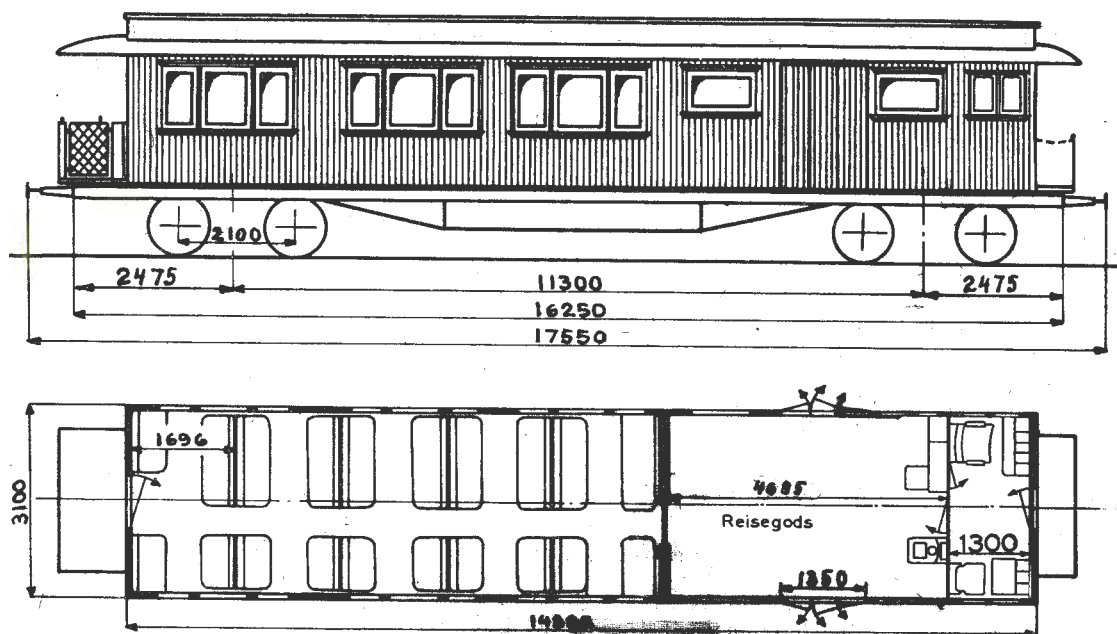

Hovedt. B. 349

Vogn nr.	Distriktsmerke	Fabrikant	Byggeår	Omtr. vognvekt i tonn	Sittepl. 2.klasse	Reisegods, last i tonn	Grunnriss	El. varme i kW	Vognutstyr (se side 6)	Merknad
73	0	Skb	90	27,0	49				1H.3.5.11.39a	Ny vognkasse i 1915

Do-39

TYPE 1

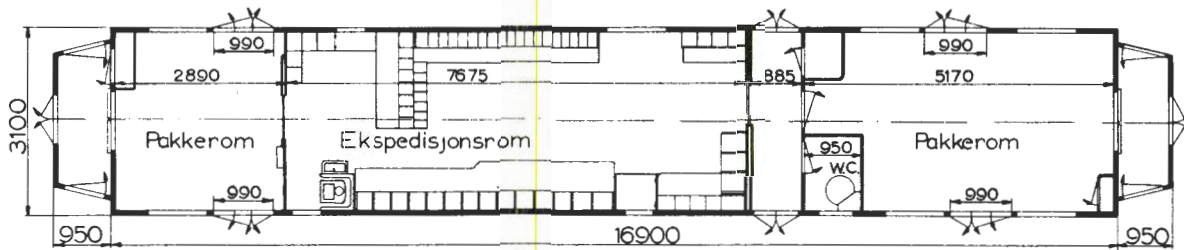
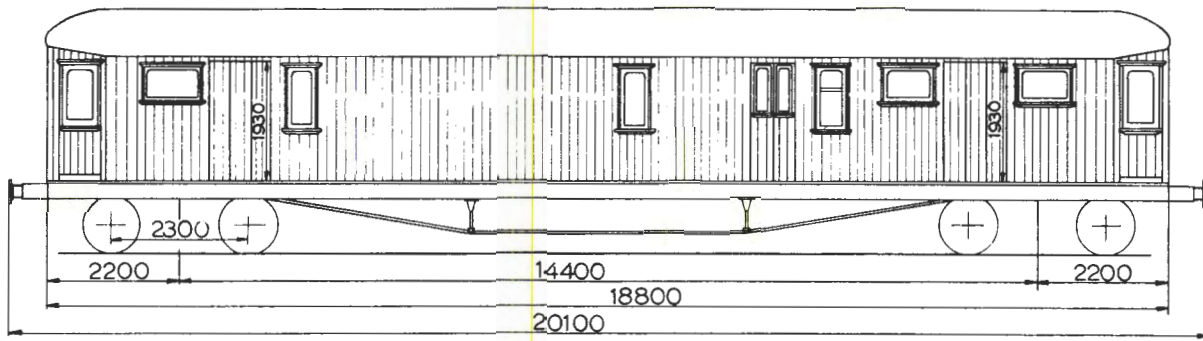

Oppr.hovedt.2583¹⁾

Vogn nr	Distriktmerke	Fabrikant	Byggeår	Omtr. vognvekt i tonn	Post, last i tonn	Grunnriss	El. varme i kW	Vognutstyr (se side 6)	Merknad
787	T	Skb	22	30,0	95			1H. 3. 5. 8. 11. 28 ²⁾ , 39a	

¹⁾ Ny vognkasse etter tegn. 5175
 Ekspedisjonsrom etter tegn. 6671
²⁾ I ende ved minste pakkerom

Trykk nr 751. 1.7.57

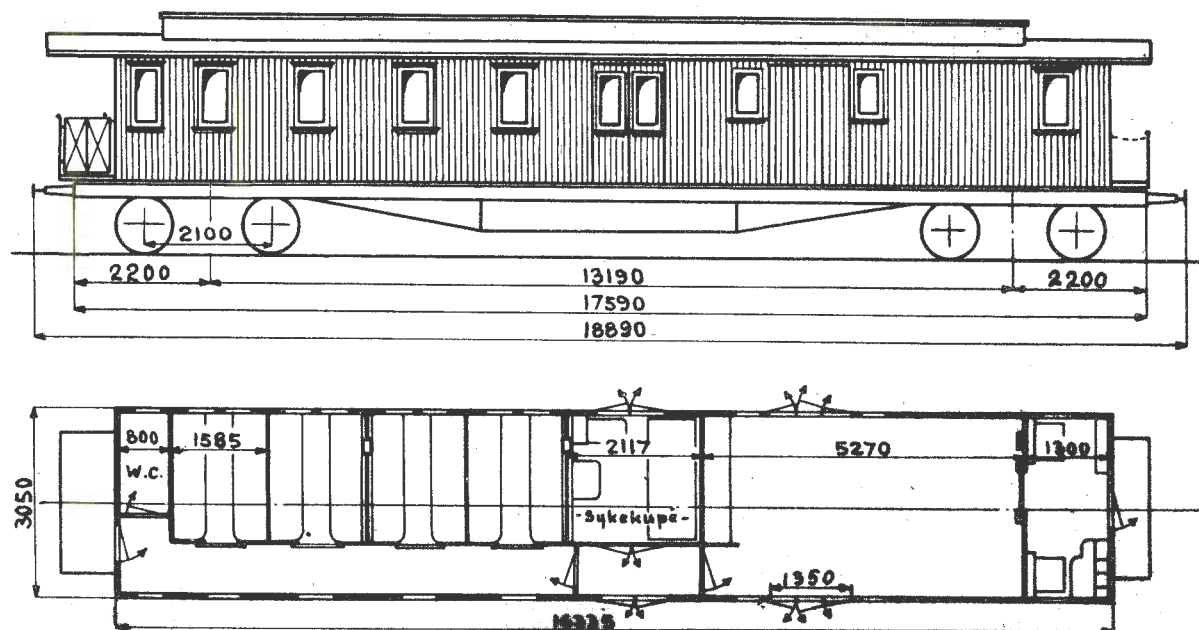

Oppr. hovedt. B. 112

Vogn nr.	Distriktsmerke	Fabrikant	Byggear	Omr. vognvekt i tonn	Sittepl. 2.klasse	Reisegods, last i tonn	Grunnriss	El. varme i kW	Vognutstyr (se side 6)	Merknad
93	0	Skb	01	29,0	32	2,0			1H.3.5.7.8.11.39a	

Do-39

TYPE 1

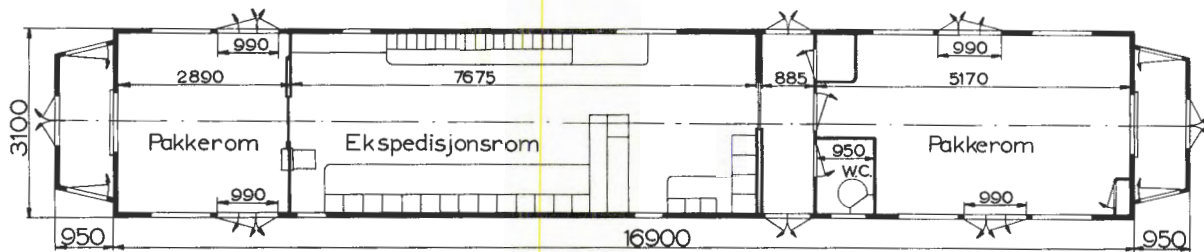
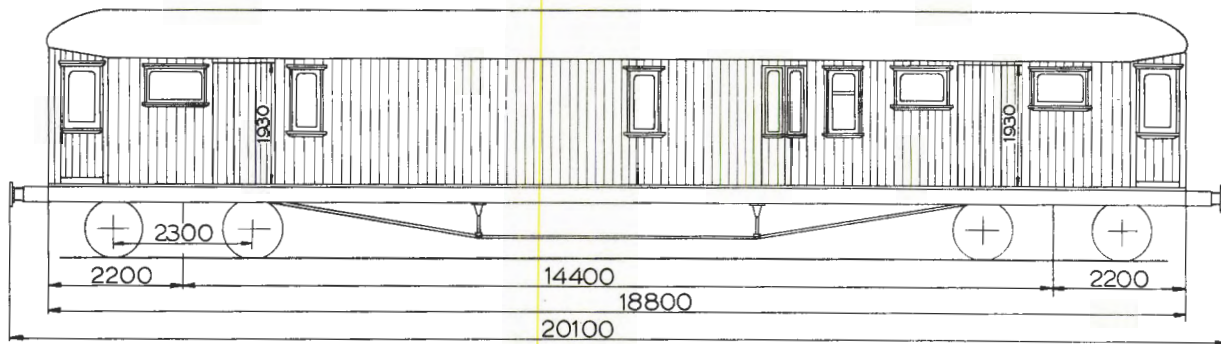

Oppr.hovedt.2583¹⁾

Vogn nr.	Distriktmerke	Fabrikant	Byggeår	Omtr. vognvekt i tonn	Post, last i tonn	Grunnriss	El. varme i kW	Vognutstyr (se side 6)	Merknad
787	T	Skb	22	30,0	95			1H. 3. 5. 8. 11. 28. 39.	

¹⁾ Ny vognkasse etter tegn. 5175

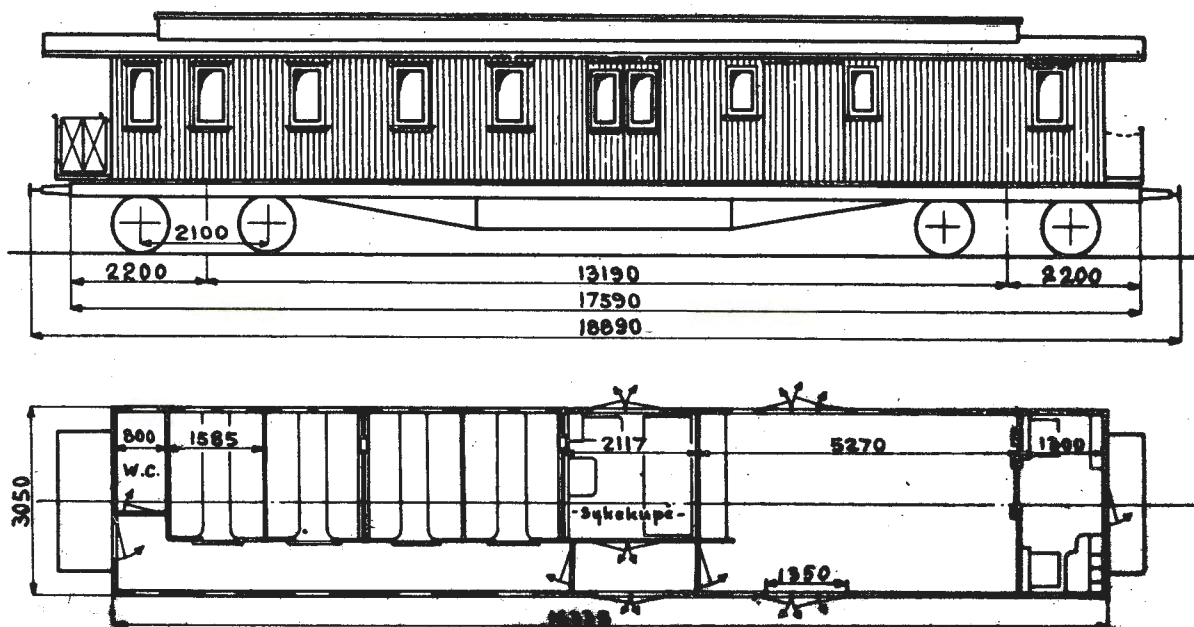

Oppr. hovedt. B. 112

Vogn nr.	Distriktsmerke	Fabrikant	Byggear	Omr. vognvekt i tonn	Sittepl. 2.klasse	Reisegods, last i tonn	Grunnriss	El. varme i kW	Vognutstyr (se side 6)	Merknad
93	0	Skb	01	29,0	32	2,0			1H.3.5.7.8.11.39a	

Do-39

TYPE 1

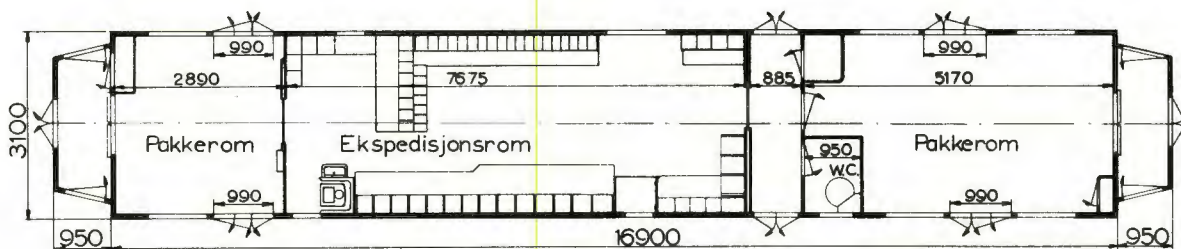
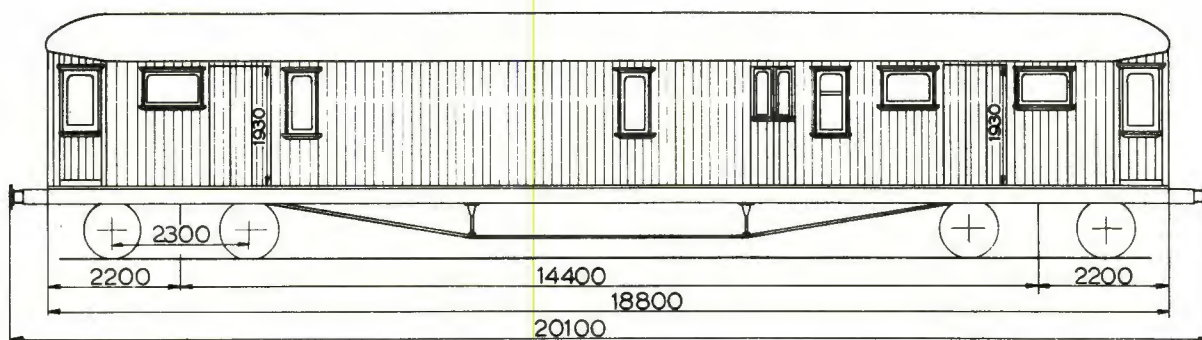

Oppr. hovedt. 2583¹⁾

Vogn nr.	Distriktsmerke	Fabrikant	Byggeår	Omtr. vognvekt i tonn	Post, last i tonn	Grunnriss	El. varme i kW	Vognutstyr (se side 6)	Merknad
787	T	Skb	22	30,0	9,5			1H. 3 5. 8. 11. 28 ²⁾ . 39a	

¹⁾ Ny vognkasse etter tegn. 5175
 Ekspedisjonsrom etter tegn. 6671
²⁾ I ende ved minste pakkerom

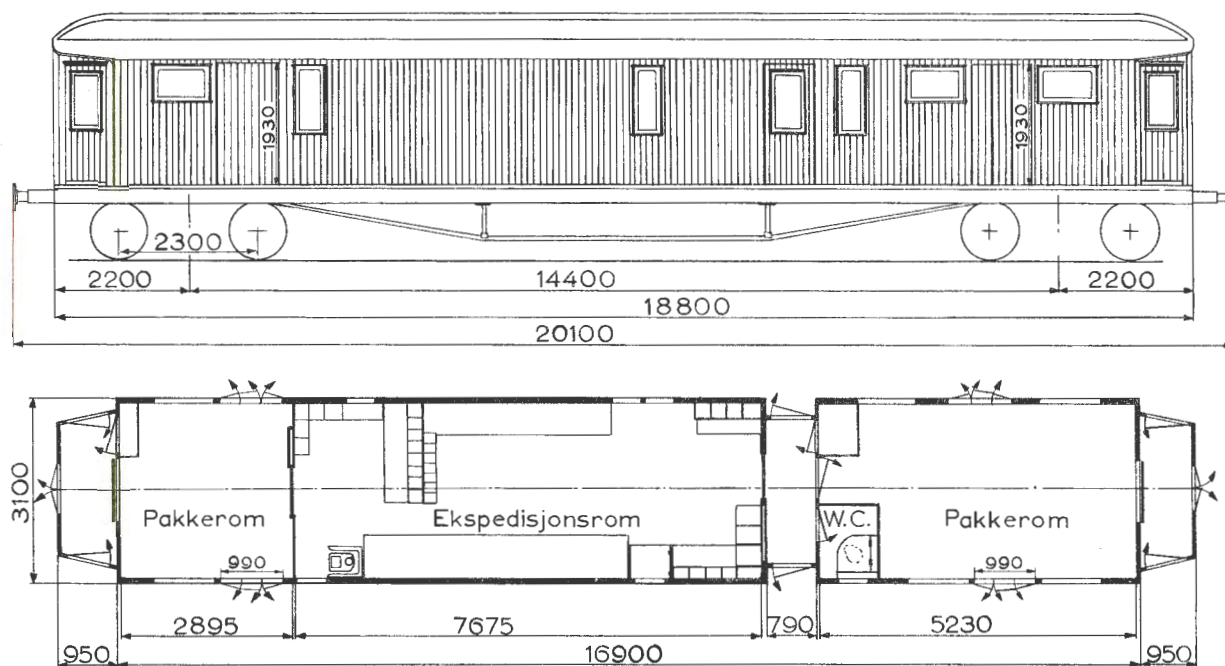
Oppr. hovedt. 2583¹

Vogn nr:	Distriktsmerke	Fabrikant	Byggeår	Omr. vognvekt i tonn	Post, last i tonn	Grunnriis	El. varme i kW	Vognutstyr (se side 6)	Merknad
18106	T	Skb	22	31,0	9,5			1H. 3. 5. 8. 11. 28. 39a.	
18107	"	"	"	"	"			1H. 3. 5. 8. 11. 28. 39a.	

¹Forandr. etter tegn. 6671

DFo-16

TYPE 1

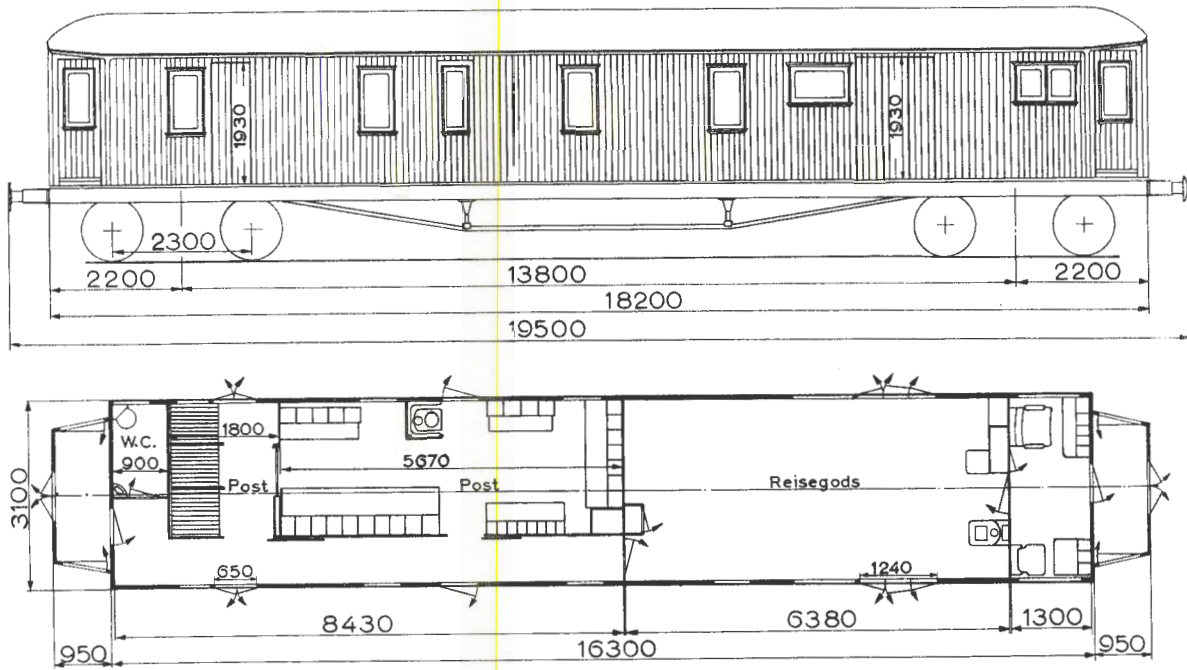

Oppr. hovedt. 2114¹⁾

Vogn nr.	Distriktsmerke	Fabrikant	Byggear	Omr. vognvekt i tonn	Post, last i tonn	Reisegods, last i tonn	Grunnriss	El. varme i kW	Vognutstyr (se side 6)	Merknad
18009	D	Skb	14	32,0	3,5	3,5			1H. 3 5. 8.11. 28. 35. 39 a.	

¹⁾Forandr. etter tegn. 5210 og 7354

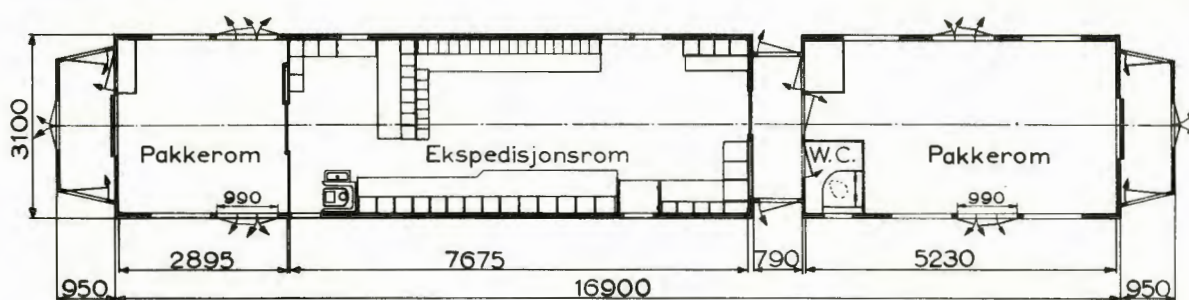
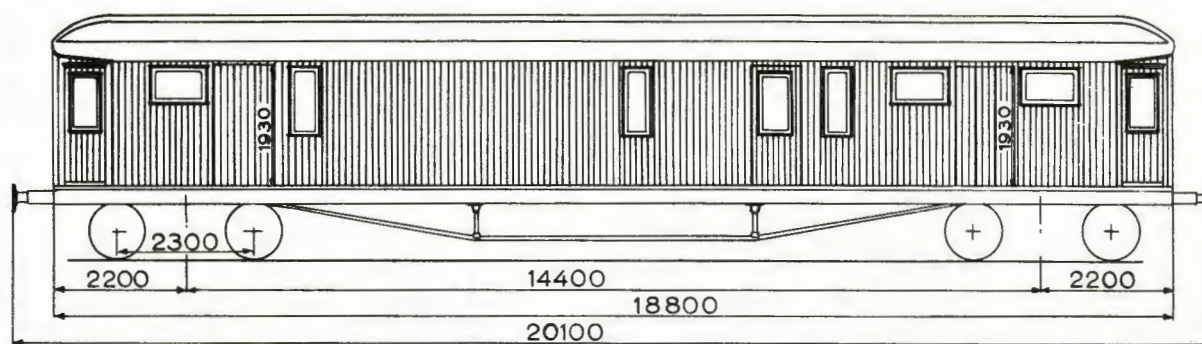
Oppr. hovedt. 2583¹

Vogn n:	Distriktsmerke	Fabrikant	Byggeår	Omr. vognvekt i tonn	Post, last i tonn	Grunnriss	El. varme i kW	Vognutstyr (se side 6)	Merknad
18106	T	Skb	22	31,0	9,5			1H. 3. 5. 8. 11. 28. 39a.	
18107	"	"	"	"	"			1H. 3. 5. 8. 11. 28. 39a.	

¹Forandr. etter tegn. 6671

DFo-16

TYPE 1

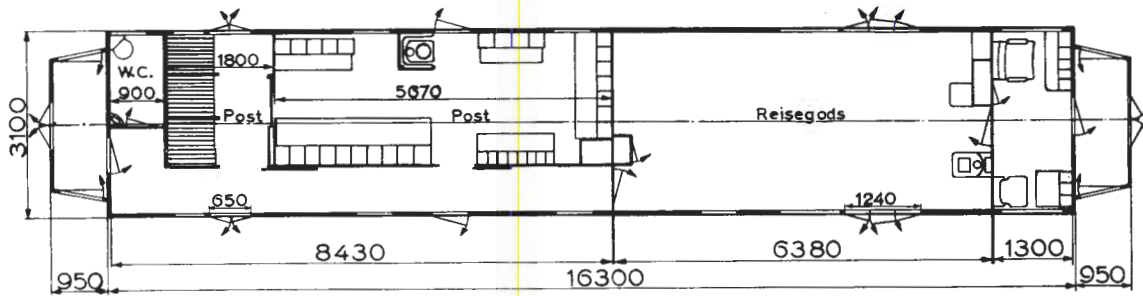
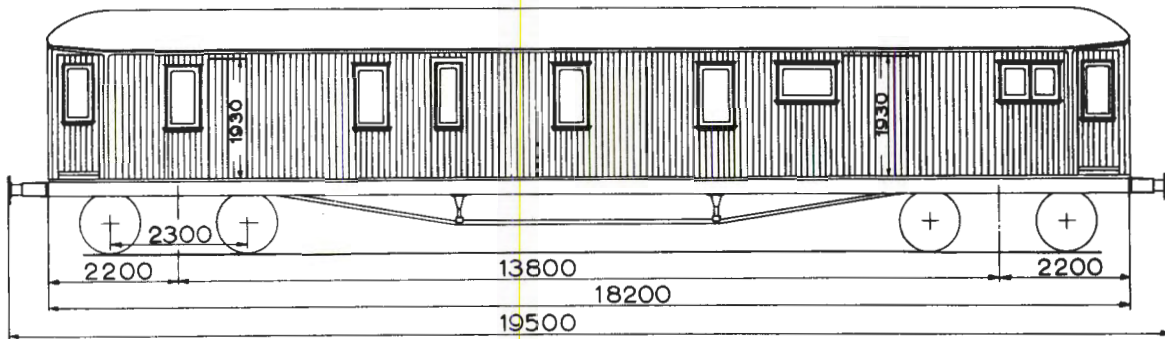

Oppr. hovedt. 2114³

Vogn nr.	Distriktsmerke	Fabrikant	Byggeår	Omr. vognvekt i tonn	Post, last i tonn	Reisegods, last i tonn	Grunnriss	El. varme i kW	Vognutstyr (se side 6)	Merknad
18009	D	Skb	14	32,0	3,5	3,5			1H. 3.5 8.11. 28.39a	

³Forandr. etter tegn. 5210 og 7354

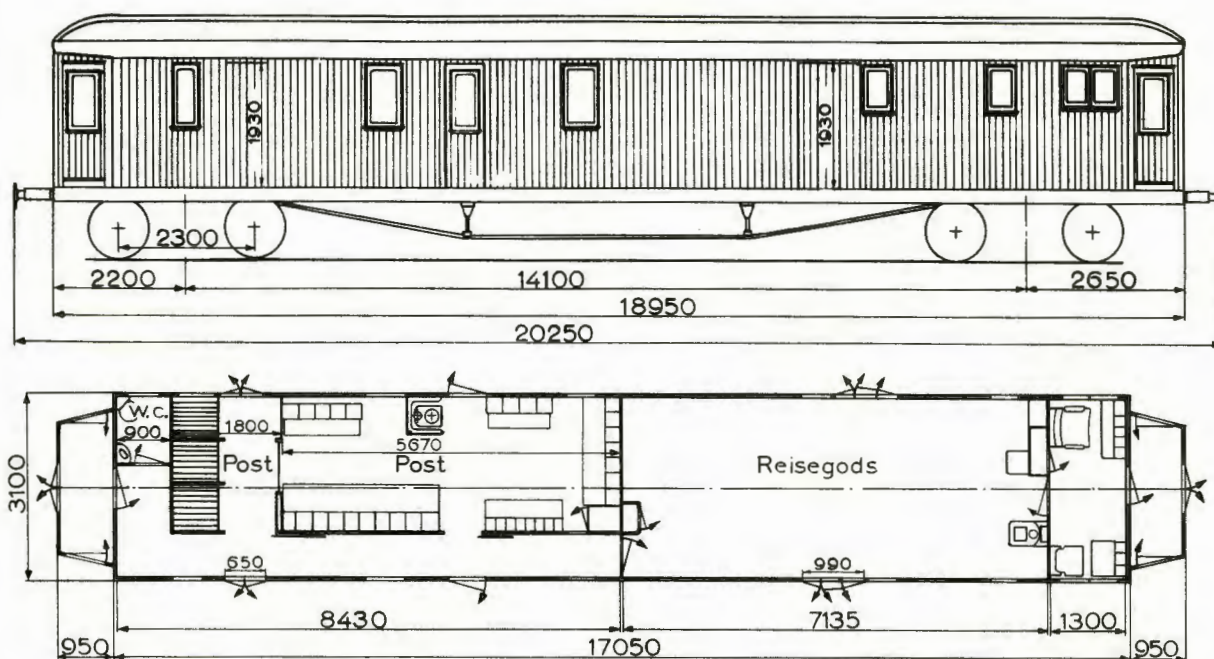
Oppr hovedt 2603^U

Vogn nr.	Distriktsmerke	Fabrikant	Byggeår	Omr. vognvekt i tonn	Post, last i tonn	Reisegods, last i tonn	Grunnriss	El. varme i kW	Vognutstyr (se side 6)	Merknad
434	D	Str	23	33,5	3,5	3,5			1kk. 3. 5 8 11. 28 39a.	
436	O	"	"	33,0	"	"			1kk. 3. 5 8 11. 28. 39a.	

^UForandr. etter tegn. 7353

DFo-18

TYPE 1

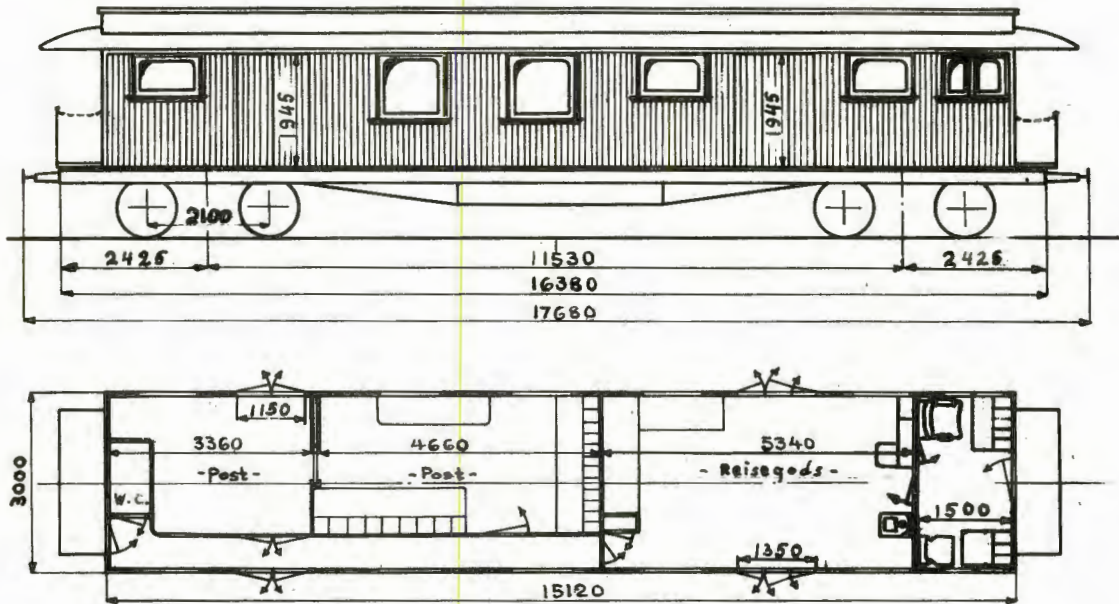

Hovedt. B. 497

Vogn nr:	Distriktsmerke	Fabrikant	Byggeår	Omr. vognvekt i tonn	Post, last i tonn	Reisegods, last i tonn	Grunnriss	El. varme i kW	Vognutstyr (se side 6)	Merknad
92	0	Skb	94	25,0	4,0	3,0			1H.3.5.8.11.39a	

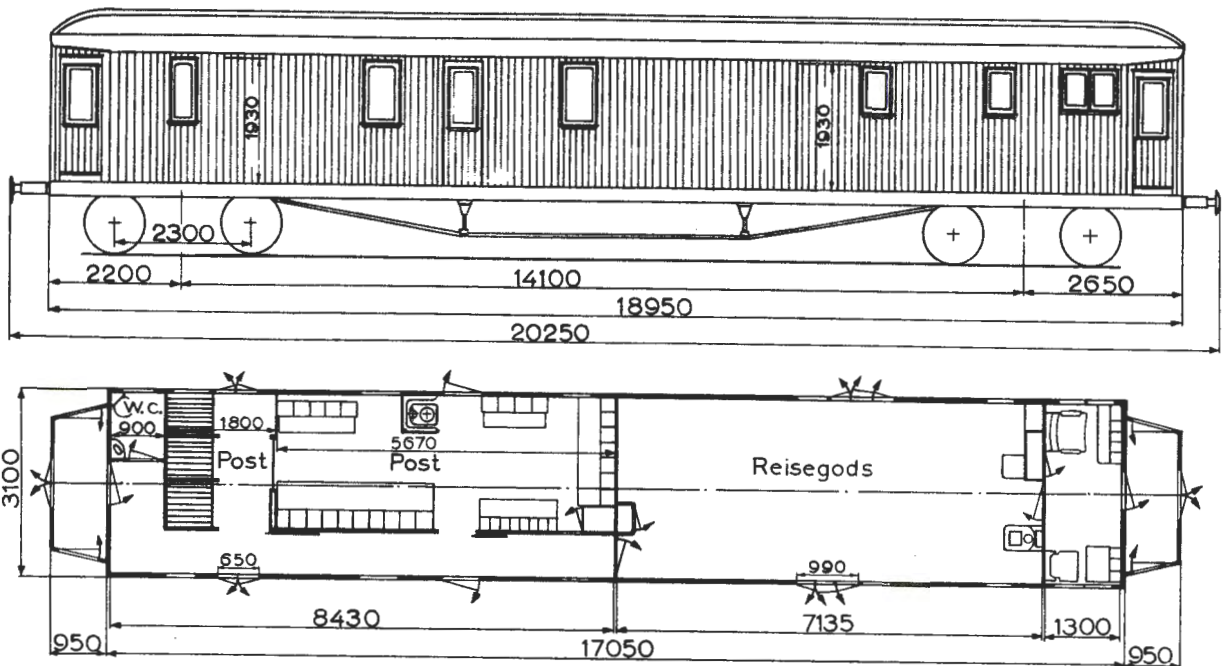
Oppr hovedt 2603^U

Vogn nr.	Distriktsmerke	Fabrikant	Byggeår	Omr. vognvekt i tonn	Post, last i tonn	Reisegods, last i tonn	Grunnriss	El. varme i kW	Vognutstyr (se side 6)	Merknad
434	D	Str	23	33,5	3,5	3,5			1kk. 3. 5. 8. 11. 28. 39a.	
436	O	"	"	33,0	"	"			1kk. 3. 5. 8. 11. 28. 39a.	

^UForandr. etter tegn. 7353

DFo-21

TYPE 1

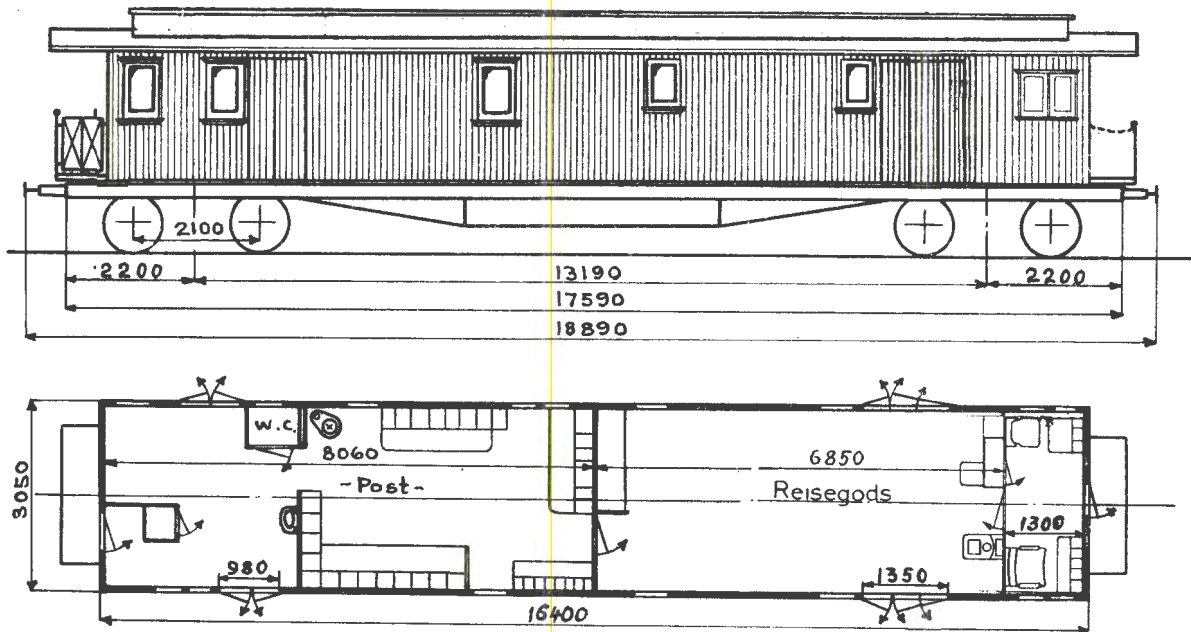

Oppr. hovedt. B. 131¹⁾

Vogn nr.	Distriktsmerke	Fabrikant	Byggeår	Omtr. vognvekt i tonn	Post, last i tonn	Reisegods, last i tonn	Grunnriss	El. varme i kW	Vognutstyr (se side 6)	Merknad
91	T	Str	03	24,0	3,5	4,5			1H.3.5.8.11	

1) Forandr. etter tegn. 4364
Trykk nr. 751 1.7.57

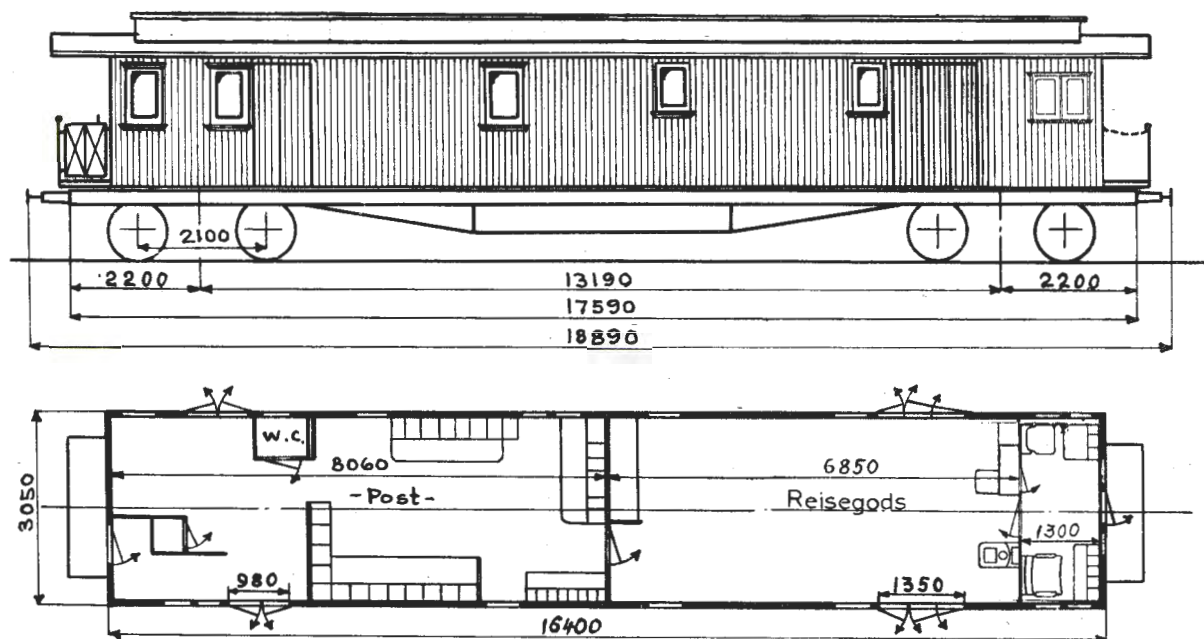
Oppr. hovedt. B. 131¹⁾

Vogn nr.	Distriktsmerke	Fabrikant	Byggeår	Omtr. vognvekt i tonn	Post, last i tonn	Reisegods, last i tonn	Grunnriss	El. varme i kW	Vognutstyr (se side 6)	Merknad
91	T	Str	03	24,0	3,5	4,5			1H.3.5.8.11	

1) Forandr. etter tegn. 4364

DFo-22

TYPE 1

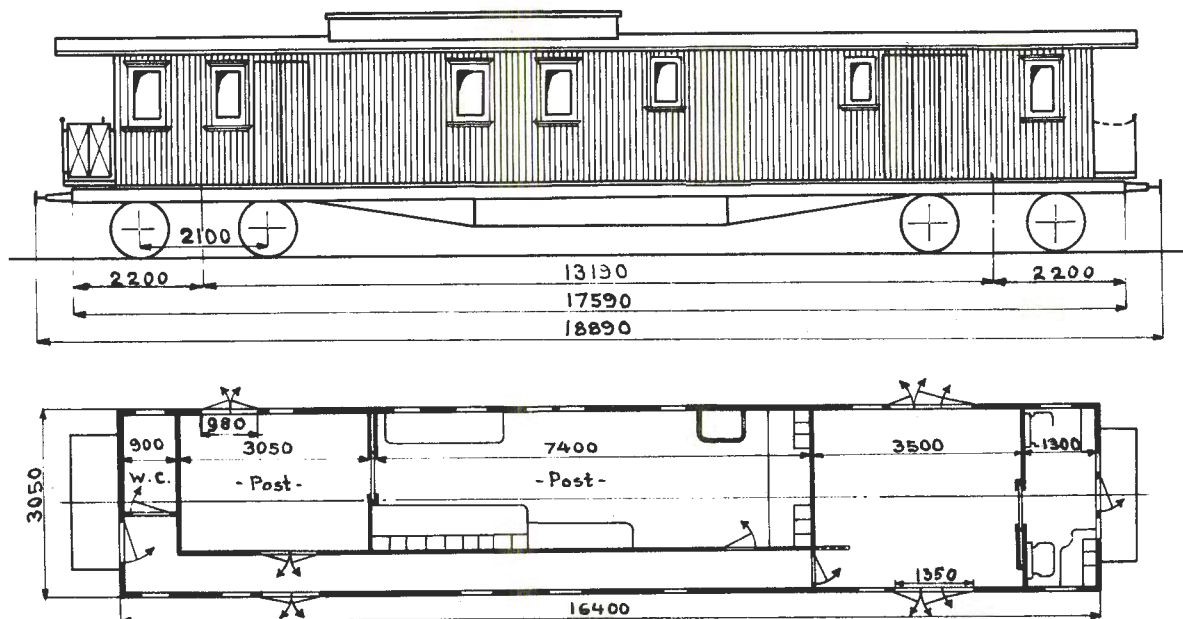

Oppr. hovedt. 523¹⁾

Vogn nr	Distriktsmerke	Fabrikant	Byggeår	Omtr. vognvekt i tonn	Post, last i tonn	Reisegods, last i tonn	Grunnriss	El. varme i kW	Vognutstyr (se side 6)	Merknad
915	0	Skb	00	25,0	6,0	3,0			1H.3.5.8.11	

1) Forandr. etter O.d. tegn. 1915
Trykk nr. 751 1.7.56

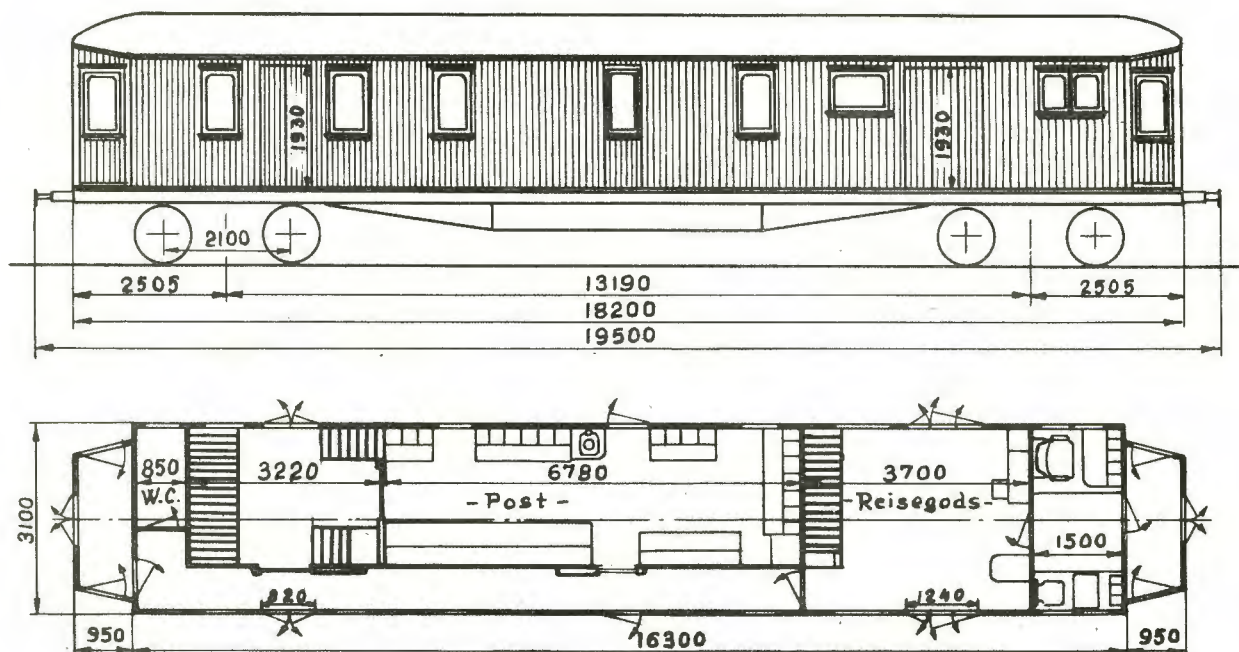
Oppr. hovedt. 439¹⁾

Vogn nr.	Distriktsmerke	Fabrikant	Byggeår	Omtr. vognvekt i tonn	Post. last i tonn	Reiseogods, last i tonn	Grunnriss	El. varme i kW	Vognutstyr (se side 6)	Merknad
911	0	Str	01	28,5	4,5	2,5			1H.3.5.8.11.28 ²⁾ .39a	} Ny vognkasse i 1948
912	"	"	"	"	"	"			1H.3.5.7.11.28 ²⁾ .39a	

1) Forandr. etter tegn. 5948

2) Bare i ende ved kond.rom

DFo-22

TYPE 3

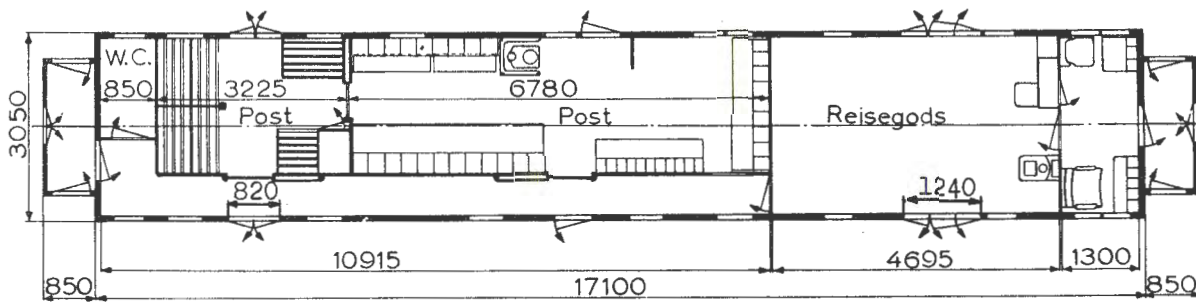
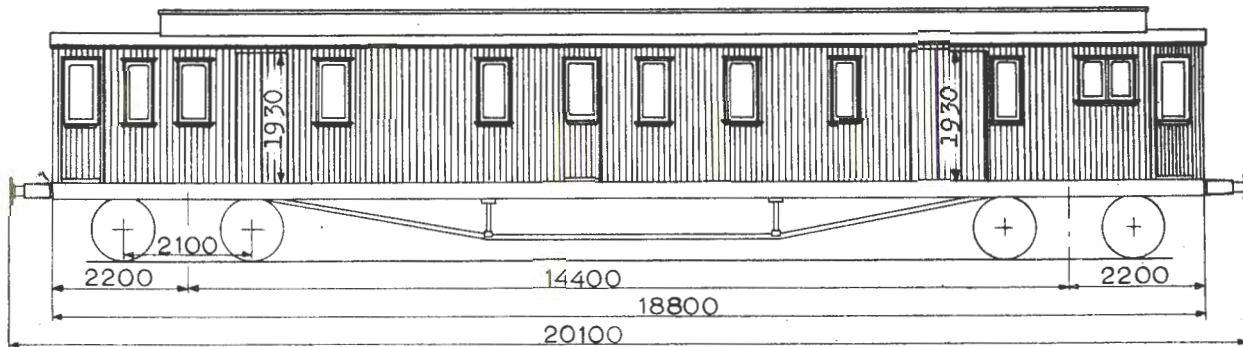

Oppr. hovedt. 968¹⁾

Vogn nr:	Distriktsmerke	Fabrikant	Byggeår	Omr. vognvekt i tonn	Post, last i tonn	Reisegods, last i tonn	Grunnpriss	El. varme i kW	Vognutstyr (se side 6)	Merknad
517	D	Skb	09	28,5	3,5	2,0			1H.3.5.8.11.28.39a	

1) Forandr. etter tegn. 5488 og skisse 1248

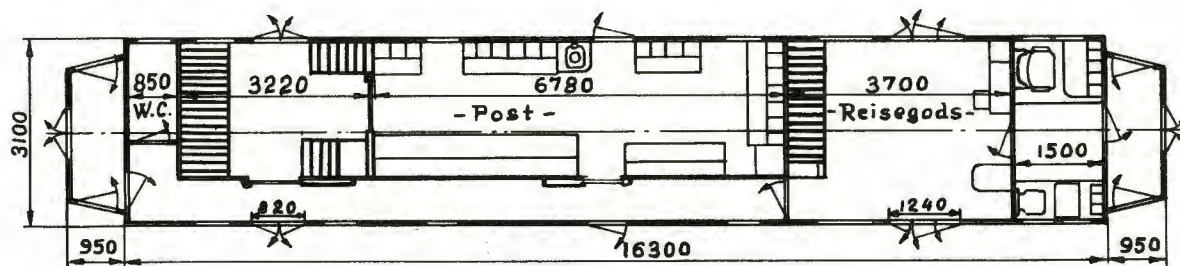
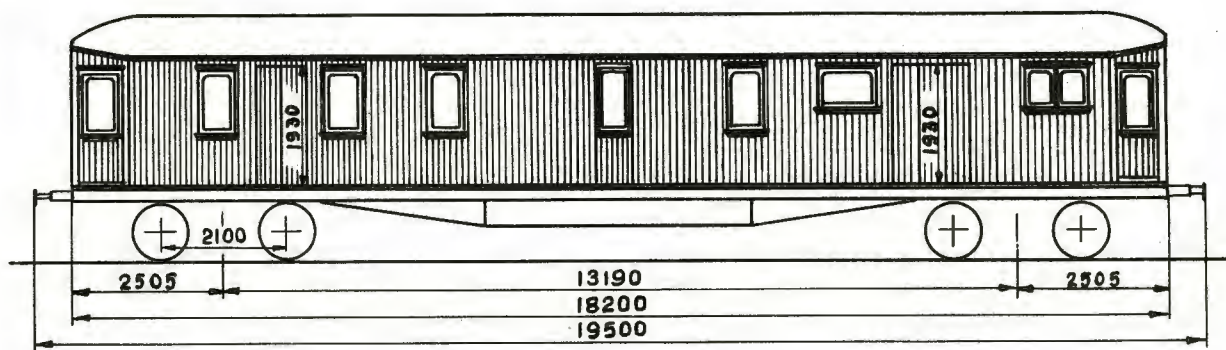
Oppr. hovedt. 439¹⁾

Vogn nr.	Distriktsmerke	Fabrikant	Byggear	Omtr. vognvekt i tonn	Post, last i tonn	Reisegods, last i tonn	Grunnriss	El. varme i kW	Vognutstyr (se side 6)	Merknad
911	0	Str	01	28,5	4,5	2,5			1H.3.5.8.11.28 ²⁾ .39a	} Ny vognkasse i 1948
912	"	"	"	29,5	"	"			1H.3.5.8.11.28 ²⁾ .39a	

1) Forandr. etter tegn. 5948

2) Bare i ende ved kond.rom

Trykk nr. 751 1.7.57

DFo-22

TYPE 3

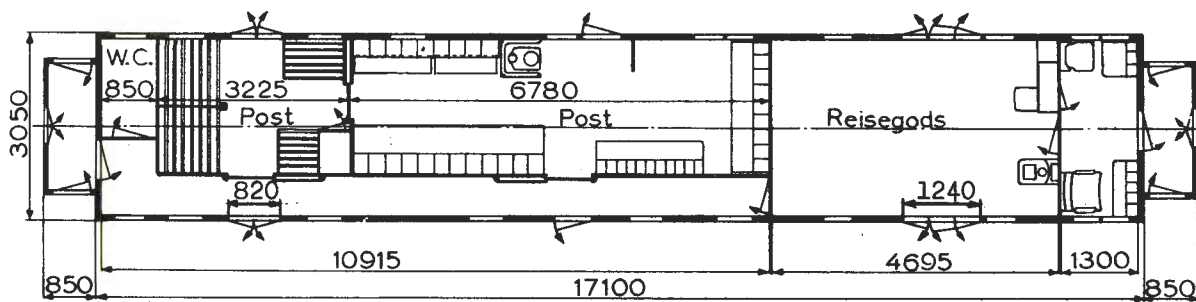
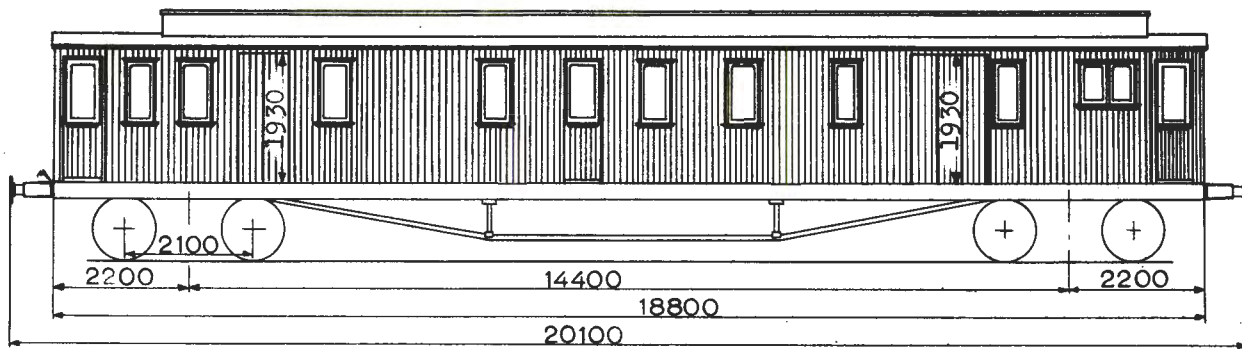

Oppr. hovedt. 968¹⁾

Vogn nr:	Distriktsmerke	Fabrikant	Byggeår	Omr. vognvekt i tonn	Post, last i tonn	Reisegods, last i tonn	Grunnriss	El. varme i kW	Vognutstyr (se side 6)	Merknad
517	D	Skb	09	28,5	3,5	2,0			1H.3.5.8.11.28.39a	

1) Forandr. etter tegn. 5488 og skisse 1248

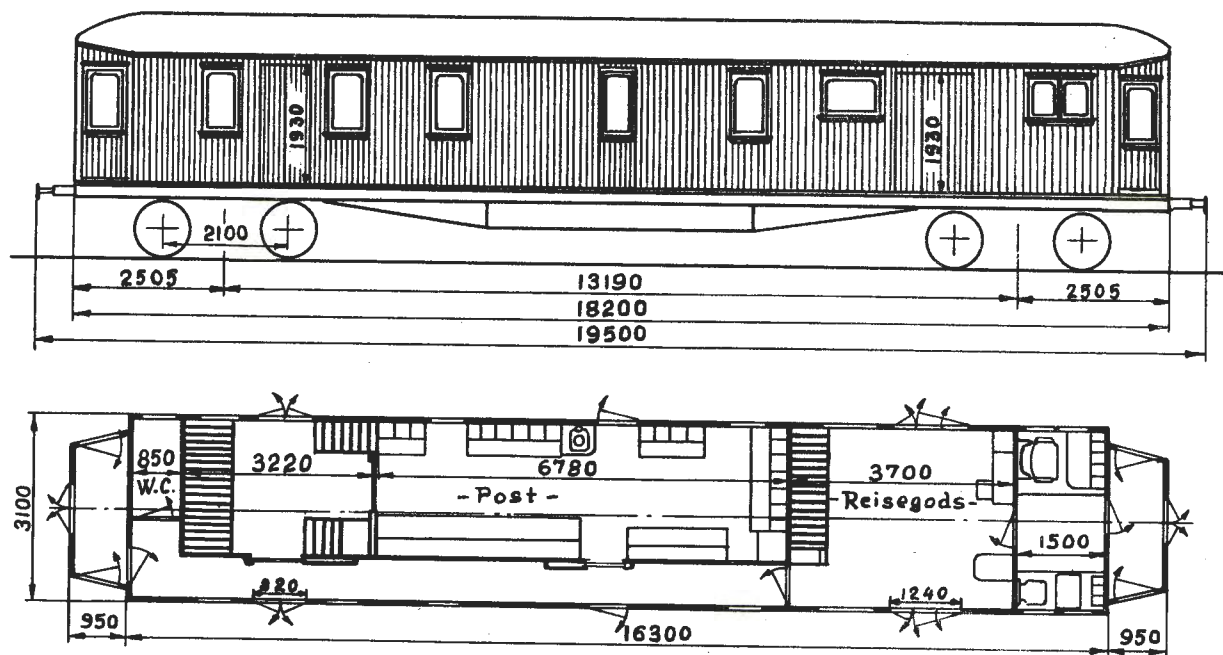
Oppr. hovedt. 439¹⁾

Vogn nr.	Distriktsmerke	Fabrikant	Byggeår	Omr. vognvekt i tonn	Post, last i tonn	Reisegods, last i tonn	Grunnriss	El. varme i kW	Vognutstyr (se side 6)	Merknad
911	0	Str	01	28,5	4,5	2,5			1H.3.5.8.11.28 ²⁾ .39a	} Ny vognkasse i 1948
912	"	"	"	29,5	"	"			1H.3.5.8.11.28 ²⁾ .39a	

1) Forandr. etter tegn. 5948

2) Bare i ende ved kond.rom

DFo-22

TYPE 3

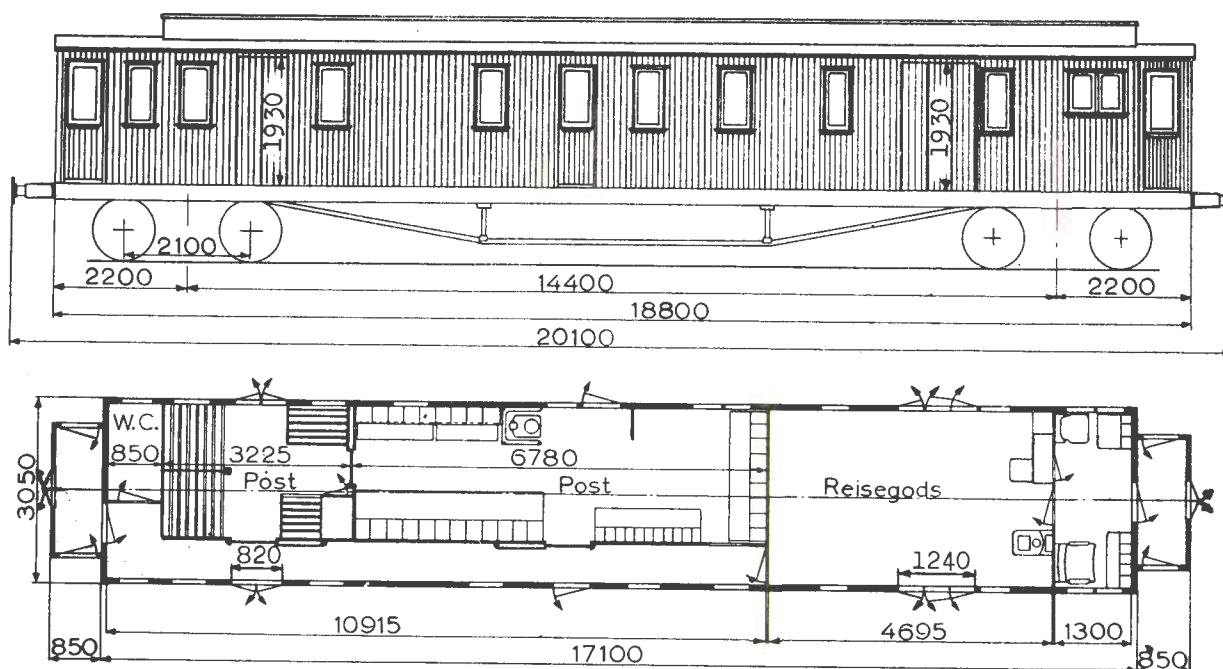

Oppr. hovedt. 968¹⁾

Vogn nr.	Distriktsmerke	Fabrikant	Byggeår	Omr. vognvekt i tonn	Post, last i tonn	Reisegods, last i tonn	Grunnriss	El. varme i kW	Vognutstyr (se side 6)	Merknad
517	D	Skb	09	28,5	3,5	2,0			1H.3.5.8.11.28.39a	

1) Forandr. etter tegn. 5488 og skisse 1248

DFo-22

TYPE 4

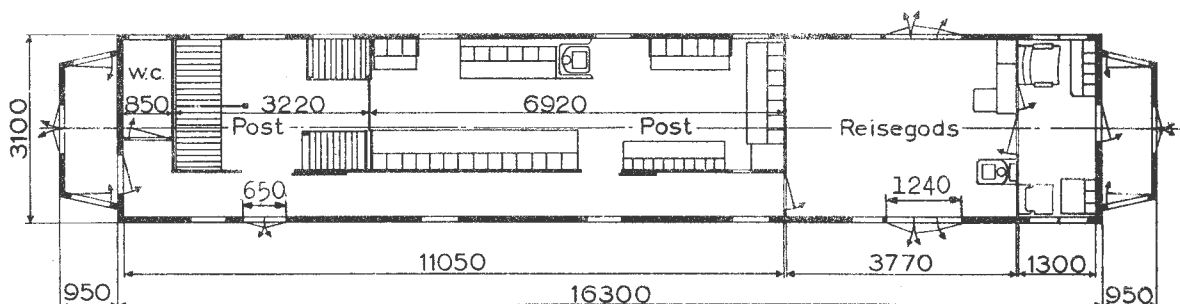
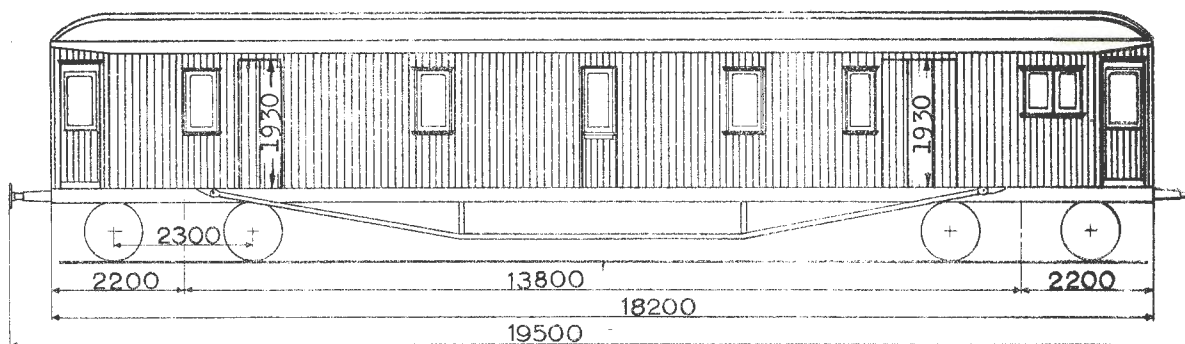

Oppr. hovedt. 1853¹⁾

Vogn nr.	Distriktsmerke	Fabrikant	Byggeår	Omtr. vognvekt i tonn	Post, last i tonn	Reisegods, last i tonn	Grunnriss	El. varme i kW	Vognutstyr (se side 6)	Merknad
432	B	SMv	20	32,0	4,5	1,5			1H.3.5.8.11.28.39a	

1) Forandr. etter tegn. 6350
Trykk nr. 751 1.7.56

DFo-22

TYPE 5

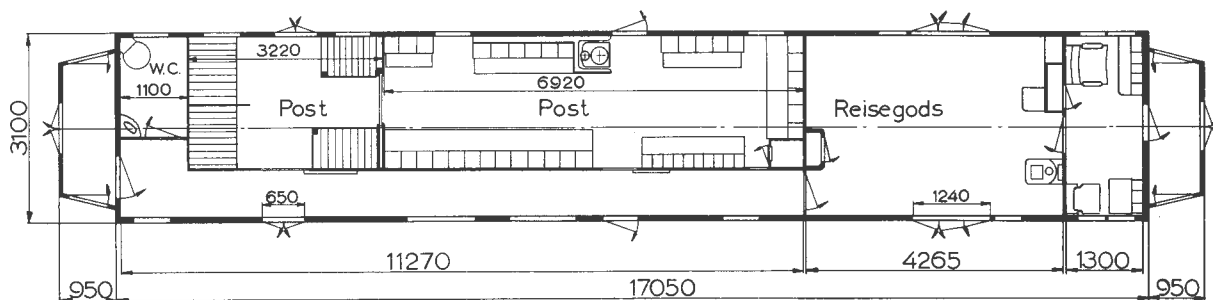
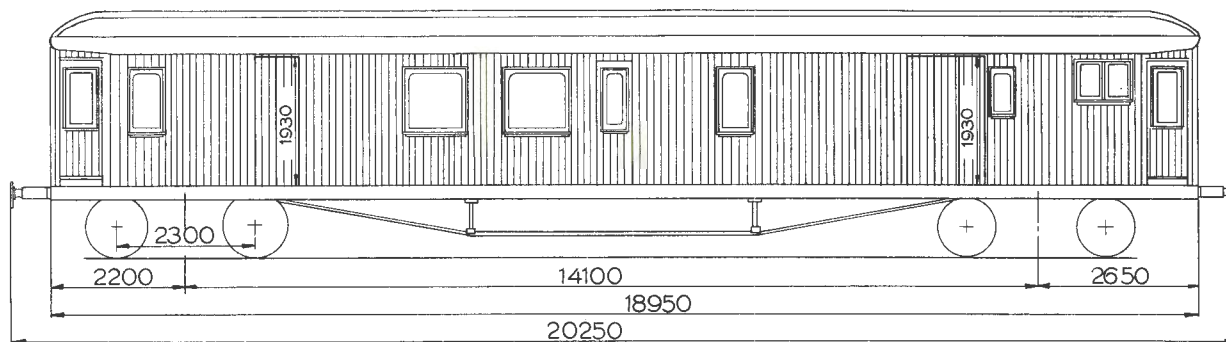

Oppr. hovedt. 1928¹⁾

Vogn nr.	Distriktsmerke	Fabrikant	Byggeår	Omtr. vognvekt i tonn	Post, last i tonn	Reisegods, last i tonn	Grunnriss	El. varme i kW	Vognutstyr (se side 6)	Merknad
875	T	SJv	21	33,0	4,5	1,5			1H. 3. 5. 8. 11. 28. 39a	

¹⁾ Forandr. etter tegn. 6597

DFo-27

TYPE 1
Stålvogner

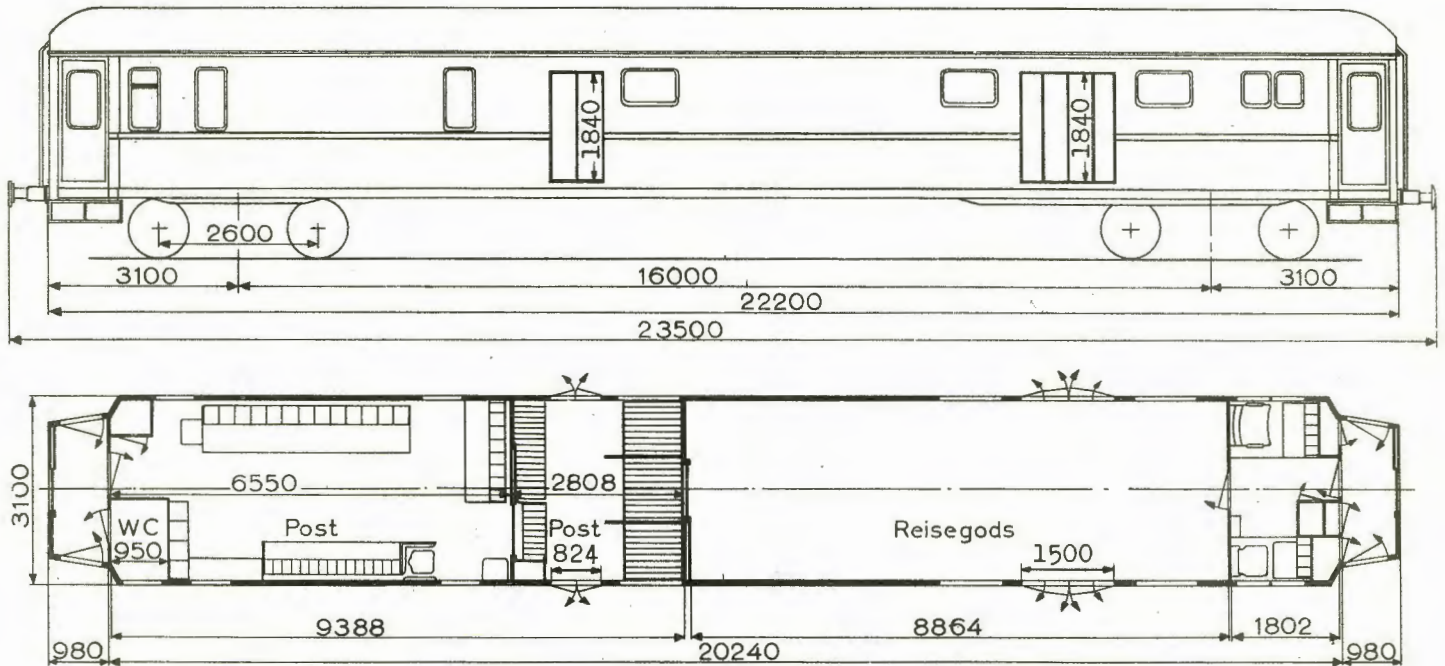

Hovedt. 6666

Vogn nr.	Distriktsmerke	Fabrikant	Byggeår	Omtr. vogntvekt i tonn	Post, last i tonn	Reisegods, last i tonn	Grunnriss	El. varme i kW	Vognutstyr (se side 6)	Merknad
21308	O	Skb	55	37,0	5,0	5,5	21	1H.3.5.8.11.28.39a		
21309	"	"	"	"	"	"	"	1H.3.5.8.11.28.39a		
21310	D	"	"	"	"	"	"	1H.3.5.8.11.28.39a		
21311	"	"	"	"	"	"	"	1H.3.5.8.11.28.39a		
21312	"	"	"	"	"	"	"	1H.3.5.8.11.28.39a		
21313	"	"	56	"	"	"	"	1H.3.5.8.11.28.39a		

DFo-29

TYPE 1

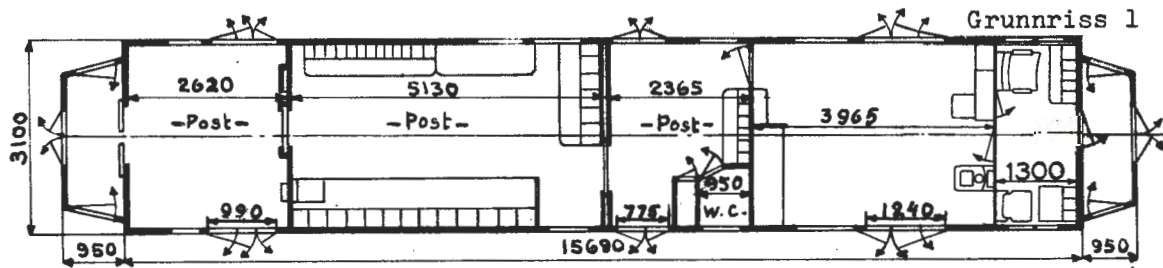
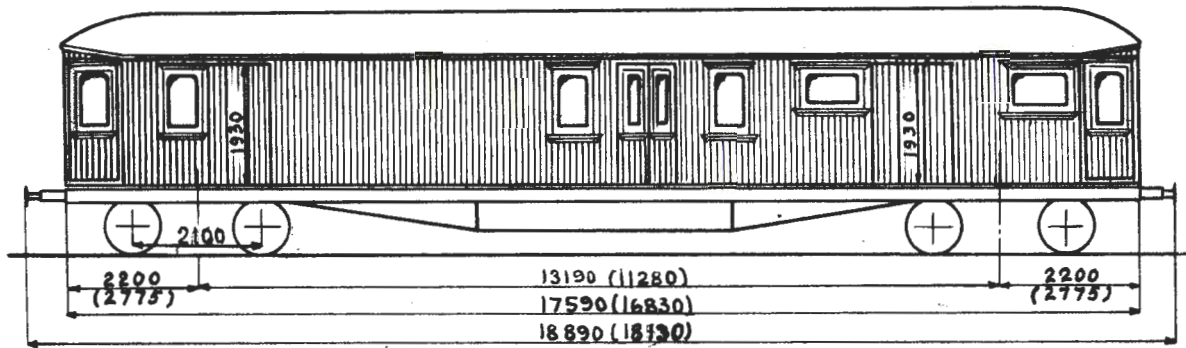

Oppr. hovedt. 523¹⁾
Grunnriss 2

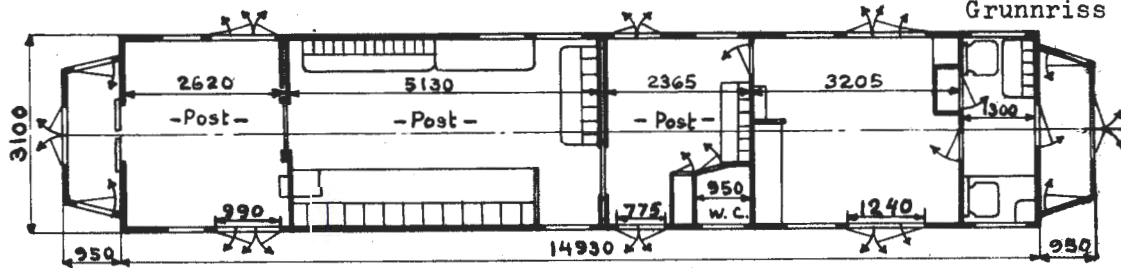

Oppr. hovedt. 220¹⁾

Vogn nr:	Distriktsmerke	Fabrikant	Byggeår	Omr. vognvekt i tonn	Post, last i tonn	Reisegods, last i tonn	Grunnriss	El. varme i kW	Vognutstyr (se side 6)	Merknad
804	0	Skb	93	25,0	4,5	1,5	2		1H.3.5.8.11.28 ²⁾ .39a	
808	"	"	01	27,5	"	"	1		1H.3.5.8.11.28 ²⁾ .39a	

Mål i () gjelder vogn nr. 804

1) Ny vognkasse etter tegn. 5160

2) Bare i ende ved konduktörrum

Trykk nr. 751 1.7.56

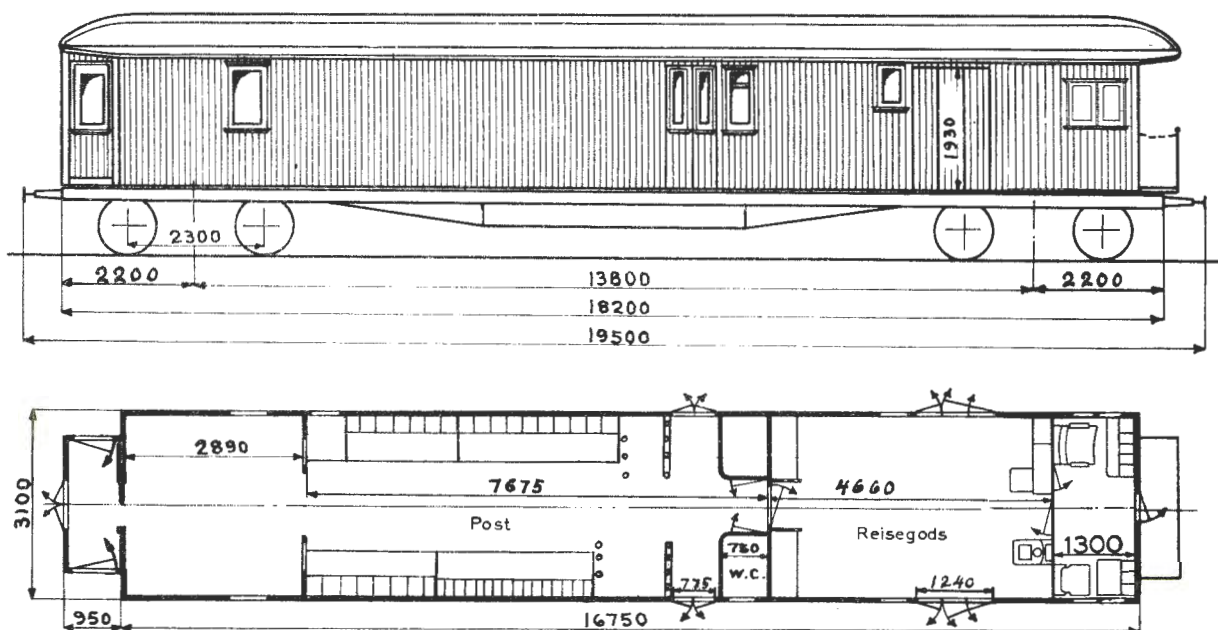
Oppr. hovedt. 2114¹⁾

Vogn nr.	Distriktsmerke	Fabrikant	Byggeår	Omr. vognvekt i tonn	Post, last i tonn	Reisegods, last i tonn	Grunnriss	El. varme i kW	Vognutstyr (se side 6)	Merknad
18010	0	Skb	14	31,0	6,5	4,5			1H.3.5.8.11.28.35.39a	

1) Forandr. etter tegn. 7058

DFo-32

TYPE 2

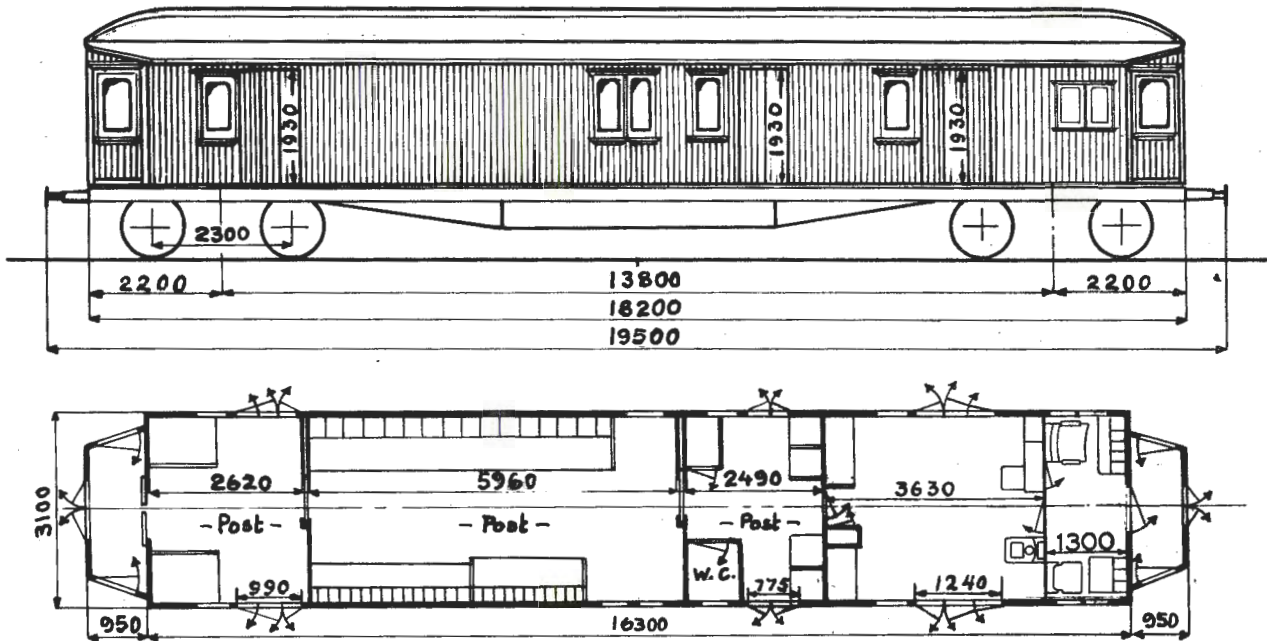

Oppr. hovedt. 1853¹⁾

Vogn nr.	Distriktsmerke	Fabrikant	Byggeår	Omr. vognvekt i tonn	Post. last i tonn	Reisegods, last i tonn	Grunnriss	El. varme i kW	Vognutstyr (se side 6)	Merknad
433	D	SMv	20	31,5	5,5	3,5			1H.3.5.8.11.28 ²⁾ .39a	
622	"	"	"	30,5	"	"			1H.3.5.8.11.28 ²⁾ .39a	
18089	"	"	"	31,0	"	"			1H.3.5.8.11.28 ²⁾ .39a	

1) Forandr. etter tegn. 4940

2) Bare i ende ved konduktörrom

DFo-32

TYPE 2

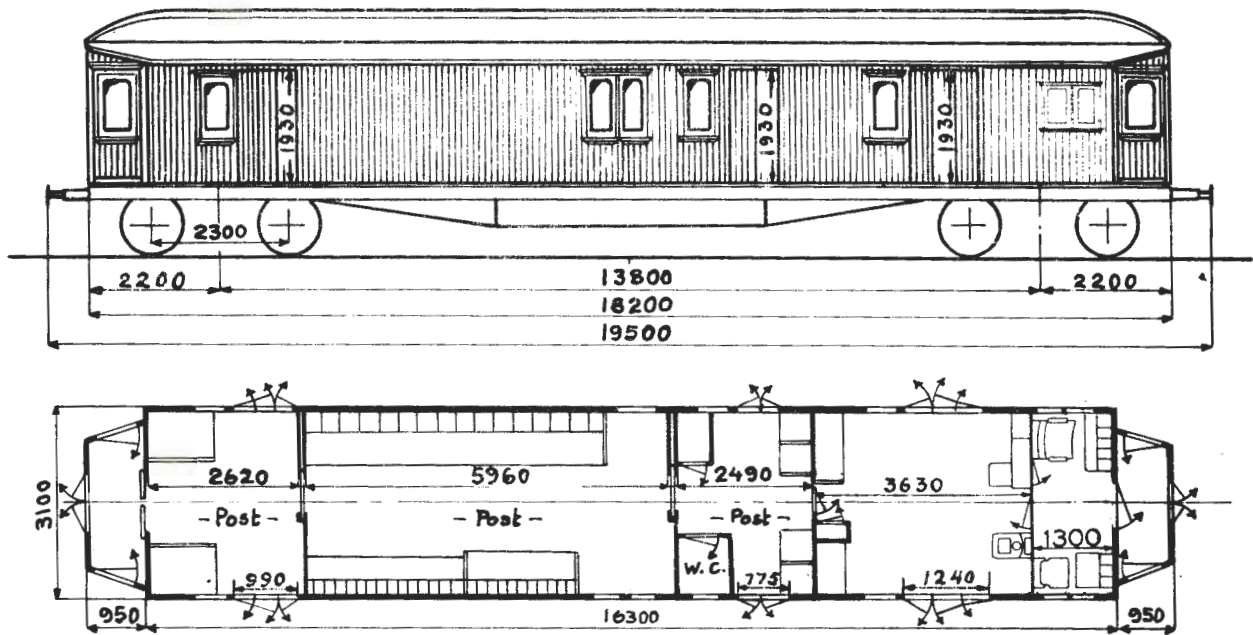

Oppr. hovedt. 1853¹⁾

Vogn nr.	Distriktsmerke	Fabrikant	Byggeår	Omtr. vognvekt i tonn	Post, last i tonn	Reisegods, last i tonn	Grunnriss	El. varme i kW	Vognutstyr (se side 6)	Merknad
433	D	SMv	20	31,5	5,5	3,5			1H.3.5.8.11.28 ²⁾ .39a	
622	"	"	"	30,5	"	"			1H.3.5.8.11.28.39a	
18089	"	"	"	31,0	"	"			1H.3.5.8.11.28 ²⁾ .39a	

1) Forandr. etter tegn. 4940

2) Bare i ende ved konduktörrom

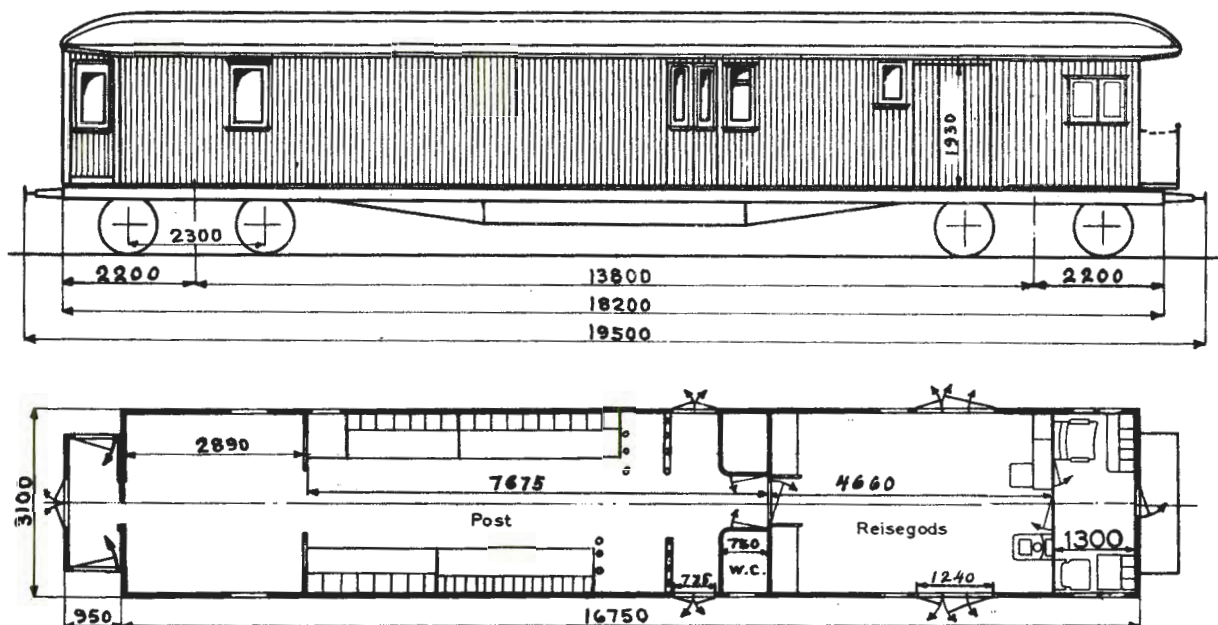
Oppr. hovedt. 2114¹⁾

Vogn nr.	Distriktsmerke	Fabrikant	Byggeår	Omtr. vognvekt i tonn	Post, last i tonn	Reisegods, last i tonn	Grunnriss	El. varme i kW	Vognutstyr (se side 6)	Merknad
18010	0	Skb	14	31,0	6,5	4,5			1H.3.5.8.11.28.35.39a	

1) Forandr. etter tegn. 7058

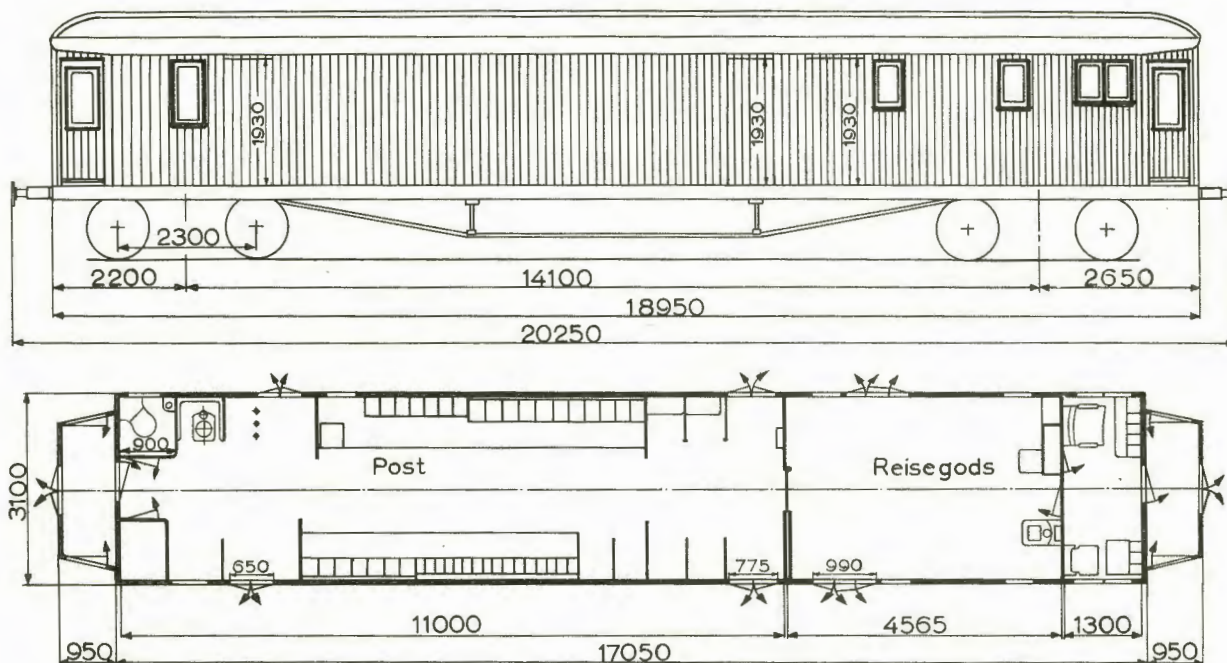
Oppr. hovedt. 2603¹

Vogn nr:	Distriktsmerke	Fabrikant	Byggeår	Omtr. vognvekt i tonn	Post, last i tonn	Reisegods, last i tonn	Grunnriss	El. varme i kW	Vognutstyr (se side 6)	Merknad
435	O	Str	23	31,0	5,0	3,5			1KK. 3. 5. 8. 11. 28. 39a.	

¹Forandr. etter skisse 1387

Trykk nr. 751 1.7.56

DFo-32

TYPE 4

Stålvogner

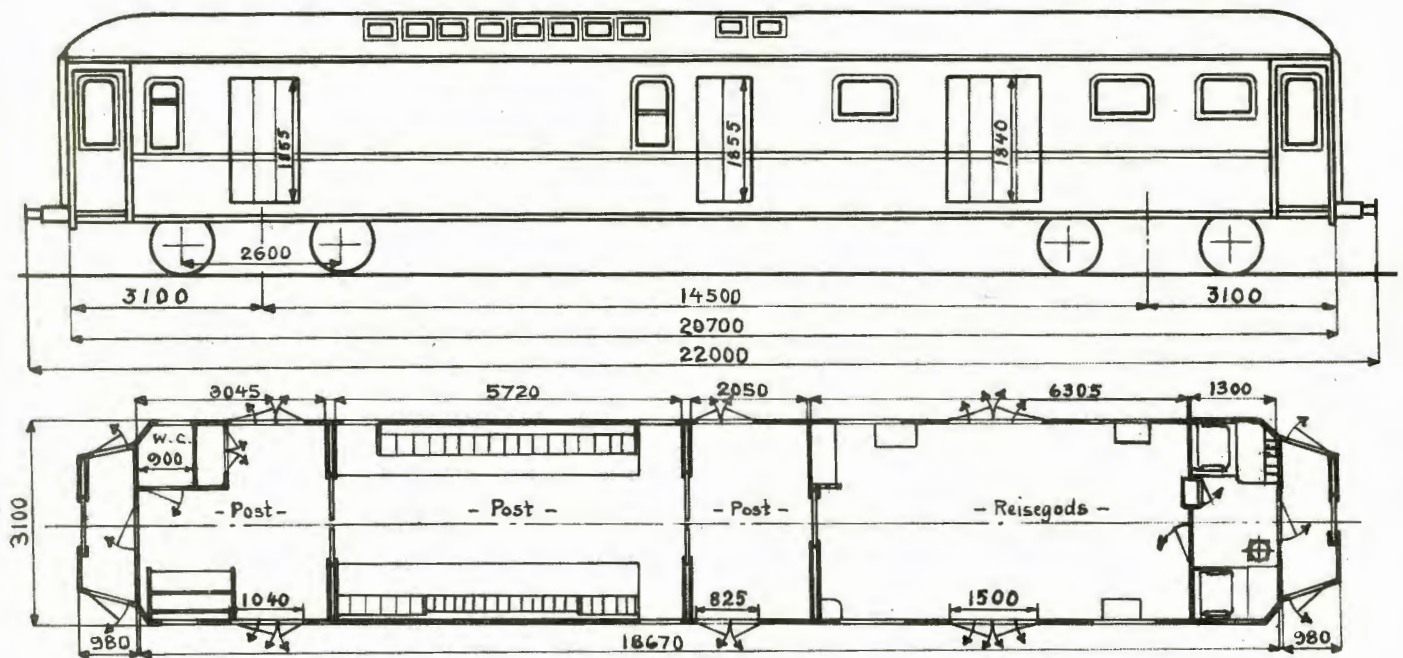

Hovedt. 4330

Vogn nr.	Distriktsmerke	Fabrikant	Byggeår	Omr. vognvekt i tonn	Post, last i tonn	Reisegods, last i tonn	Grunnriss	El. varme i kW	Vognutstyr (se side 6)	Merknad
21301	0	Skb	42	32,5	5,5	4,0	24	1H.3.6.11.28.39a		
21302	"	"	"	"	"	"	"	1H.3.6.11.28.39a		
21303	"	"	"	"	"	"	"	1H.3.6.11.28.39a		

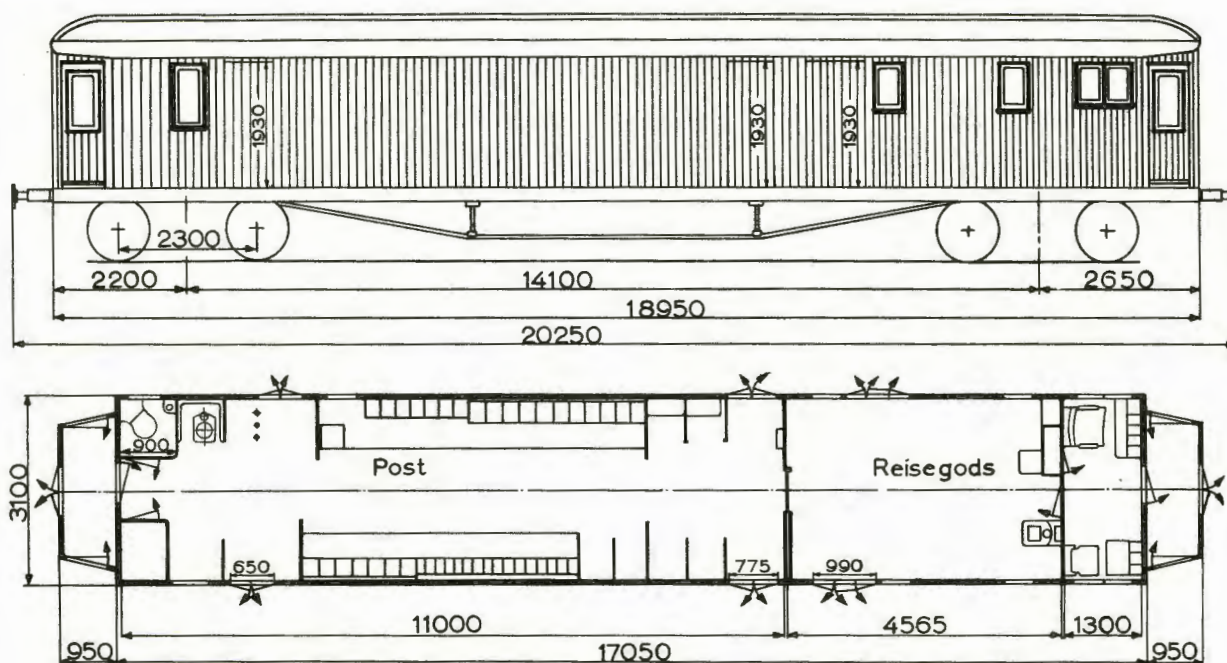
Oppr. hovedt. 2603¹

Vogn nr:	Distriktsmerke	Fabrikant	Byggedår	Omr. vognvekt i tonn	Post. last i tonn	Reisegods, last i tonn	Grunnriss	El. varme i kW	Vognutstyr (se side 6)	Merknad
435	O	Str	23	31,0	5,0	3,5			1KK. 3. 5. 8. 11. 28. 39a.	

¹Forandr. etter skisse 1387

Trykk nr. 751 1.7.56

DFo-32

TYPE 4
Stålvogner

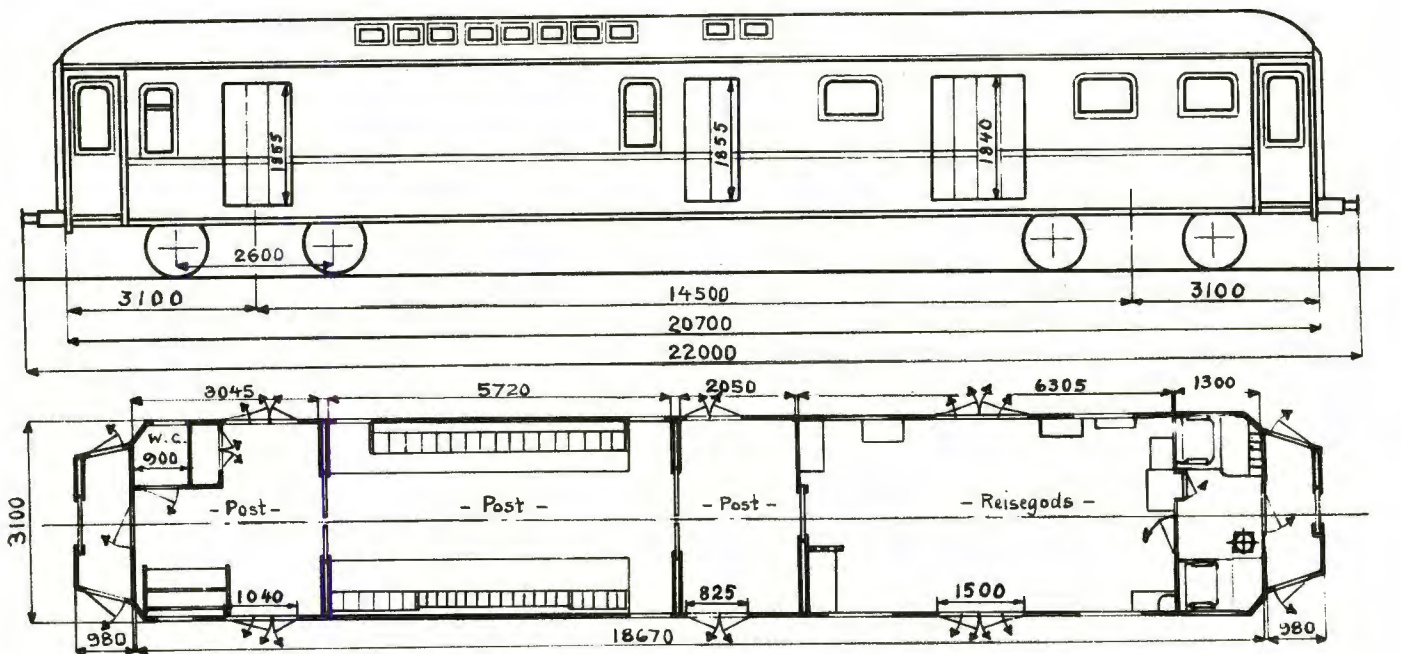

Hovedt. 4330¹⁾

Vogn nr.	Distriktsmerke	Fabrikant	Byggeår	Omtrentlig vognvekt i tonn	Post, last i tonn	Reisegods, last i tonn	Grunnriss	El. varme i kW	Vognutstyr (se side 6)	Merknad
21301	0	Skb	42	32,5	5,5	4,0	24	1H.3.6.11.28.39a		
21302	"	"	"	"	"	"	"	1H.3.6.11.28.39a		
21303	"	"	"	"	"	"	"	1H.3.6.11.28.39a		

1) Reisegodsrom forandr. etter Od.M. skisse dat. 11.10.55.

DFo-37

TYPE 1
Stålvogner

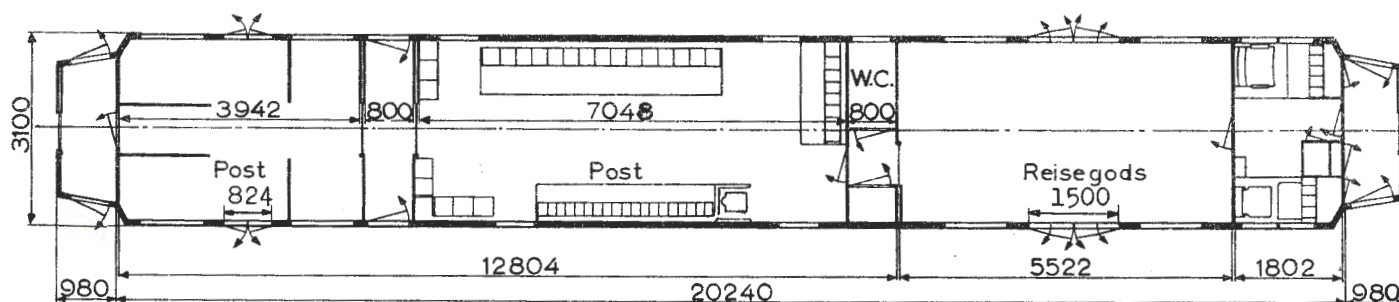
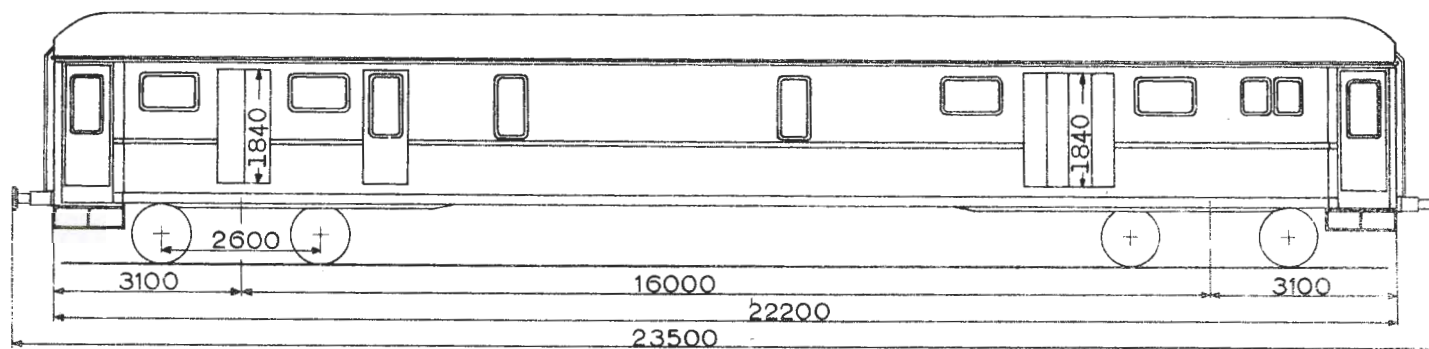

Hovedt. 6565

Vogn nr	Distriktsmerke	Fabrikant	Byggeår	Omr. vognvekt i tonn	Post, last i tonn	Reisegods, last i tonn	Grunnriss	El. varme i kW	Vognutstyr (se side 6)	Merknad
21304	B	Skb	54	38,0	6,7	3,0		23	1H.3.5.8.11.28 ¹⁾ .39a	
21305	"	"	55	"	"	"		"	1H.3.5.8.11.28 ¹⁾ .39a	
21306	O	"	54	"	"	"		"	1H.3.5.8.11.28.39a	
21307	"	"	55	"	"	"		"	1H.3.5.8.11.28.39a	

1) Bare i ende ved konduktörrom
Trykk nr. 751 1.7.56

DFZo-16

TYPE 1

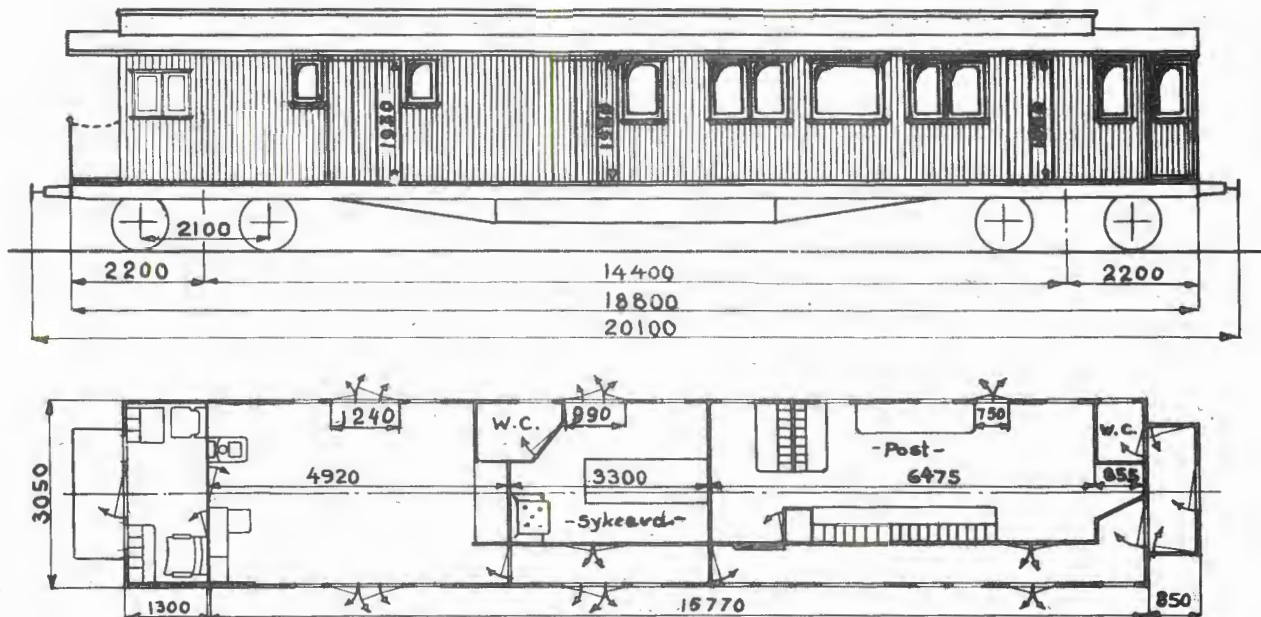

Oppr. hovedt. 989¹⁾

Vogn nr.	Distriktsmerke	Fabrikant	Byggeår	Omr. vognvekt i tonn	Post, last i tonn	Reisegods, last i tonn	Grunnriss	El. varme i kW	Vognutstyr (se side 6)	Merknad
512	D	Str	09	29,0	2,0	2,0			1H.3.5.8.11.28.39a	
513	"	"	"	28,5	"	"			1H.3.5.8.11.28.39a	

1) Forandr. etter tegn. 4067
Trykk nr. 751 1.7.56

DFo-37

TYPE 1
Stålvogner

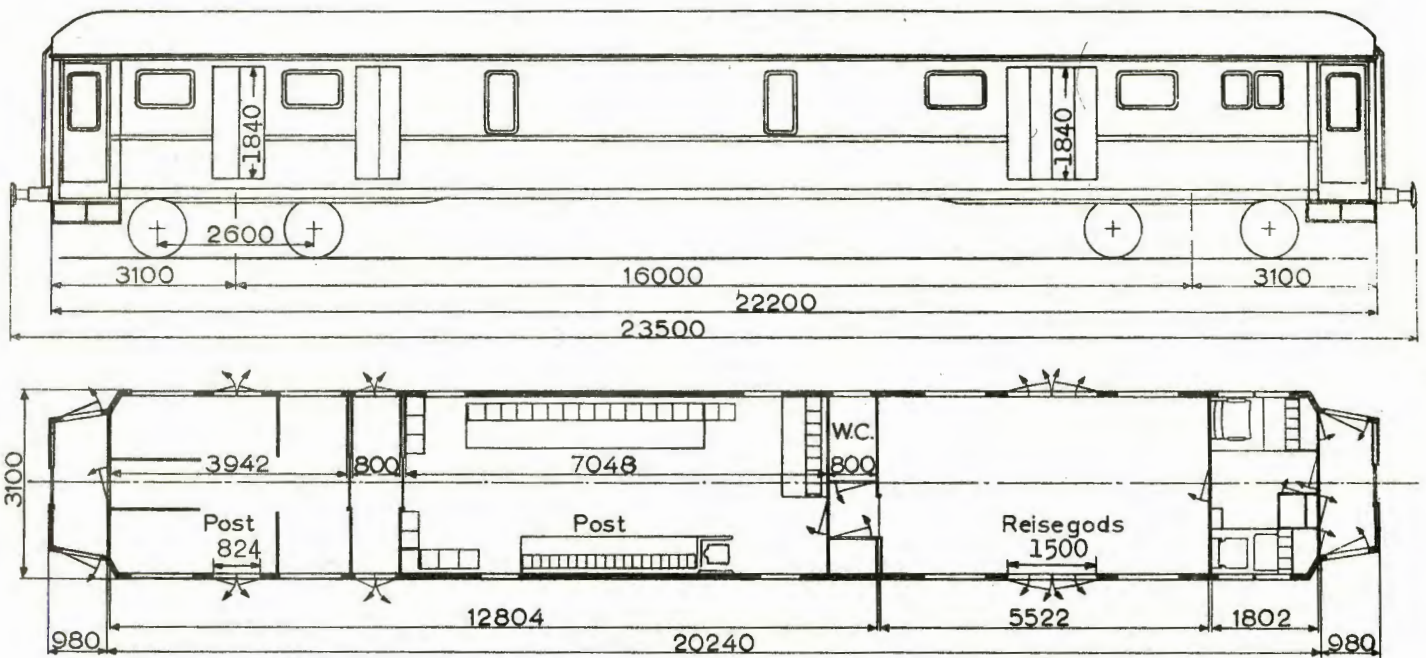

Hovedt. 6565

Vogn nr.	Distriktsmerke	Fabrikant	Byggeår	Omr. vognvekt i tonn	Post, last i tonn	Reisegods, last i tonn	Grunnriss	El. varme i kW	Vognutstyr (se side 6)	Merknad
21304	B	Skb	54	38,0	6,7	3,0	23	1H.3.5.8.11.39a		
21305	"	"	55	"	"	"	"	1H.3.5.8.11.39a		
21306	0	"	54	"	"	"	"	1H.3.5.8.11.28.39a		
21307	"	"	55	"	"	"	"	1H.3.5.8.11.28.39a		

DFZo-16

TYPE 1

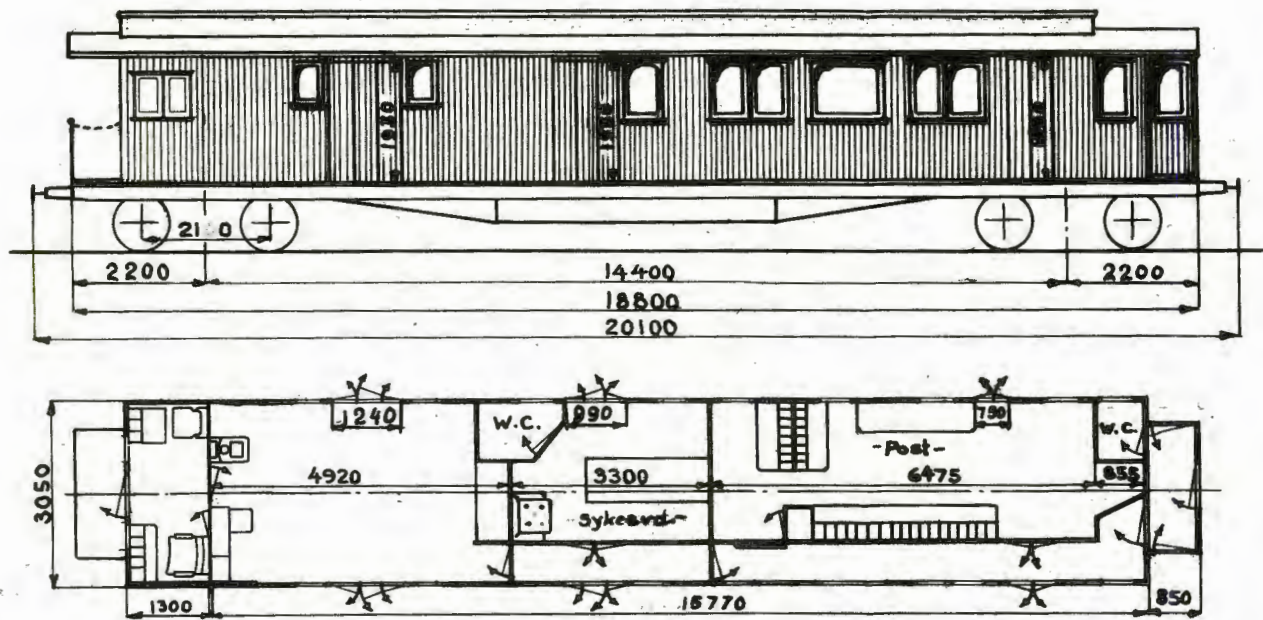

Oppr. hovedt. 989¹⁾

Vogn nr.	Distriktsmerke	Fabrikant	Byggeår	Omr. vognvekt i tonn	Post, last i tonn	Reisegods, last i tonn	Grunnriss	El. varme i kW	Vognutstyr (se side 6)	Merknad
512	D	Str	09	29,0	2,0	2,0			1H.3.5.8.11.28.39a	
513	=	=	=	28,5	"	"			1H.3.5.8.11.28.39a	

1) Forandr. etter tegn. 4067
Trykk nr. 751 1.7.56

DFo-37

TYPE 1
Stålvogner

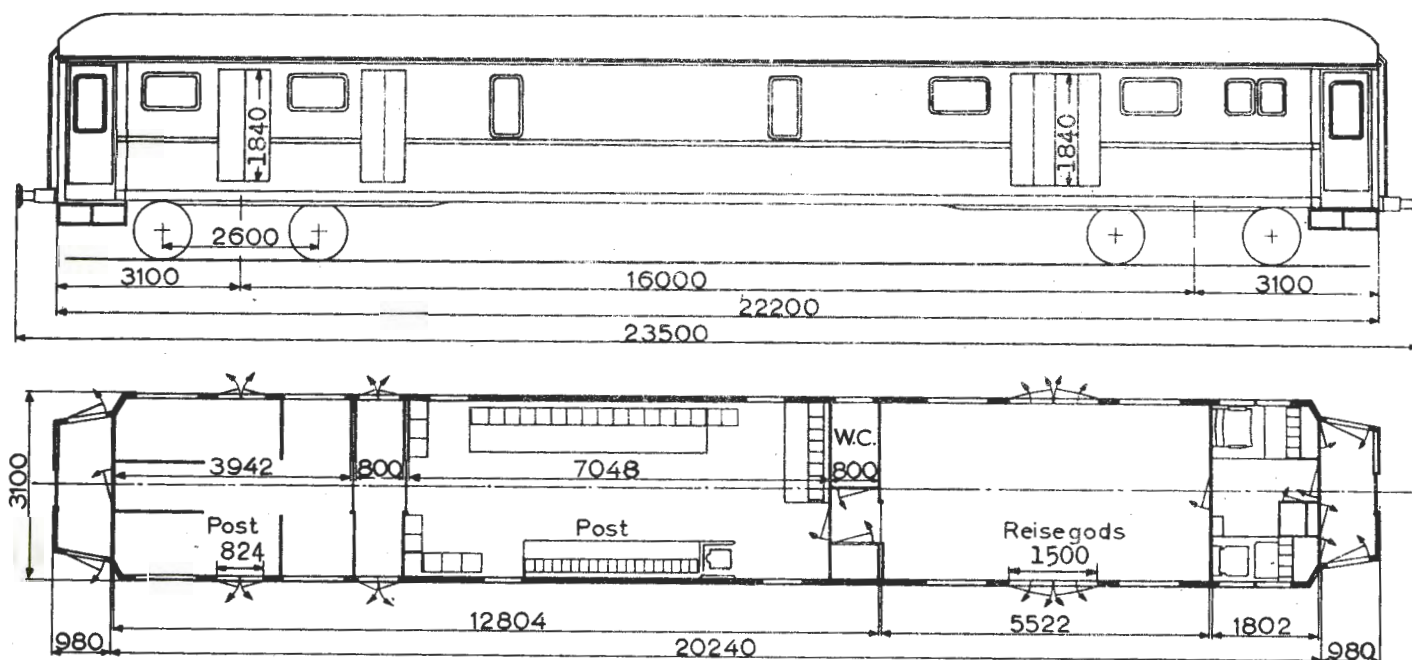

Hovedt. 6565

Vogn nr:	Distriktsmerke	Fabrikant	Byggeår	Omr: vognvekt i tonn	Postlast i tonn	Reisegods, last i tonn	Grunnriss	El. varme i kW	Vognutstyr (se side 6)	Merknad
21304	B	Skb	54	38,0	6,7	3,0	23	1H.3.5.8.11.28 ¹⁾ .39a		
21305	"	"	55	"	"	"	"	1H.3.5.8.11.28 ¹⁾ .39a		
21306	0	"	54	"	"	"	"	1H.3.5.8.11.28.39a		
21307	"	"	55	"	"	"	"	1H.3.5.8.11.28.39a		

1) Bare i ende ved konduktörrom
Trykk nr. 751 1.7.58

DFZo-16

TYPE 1

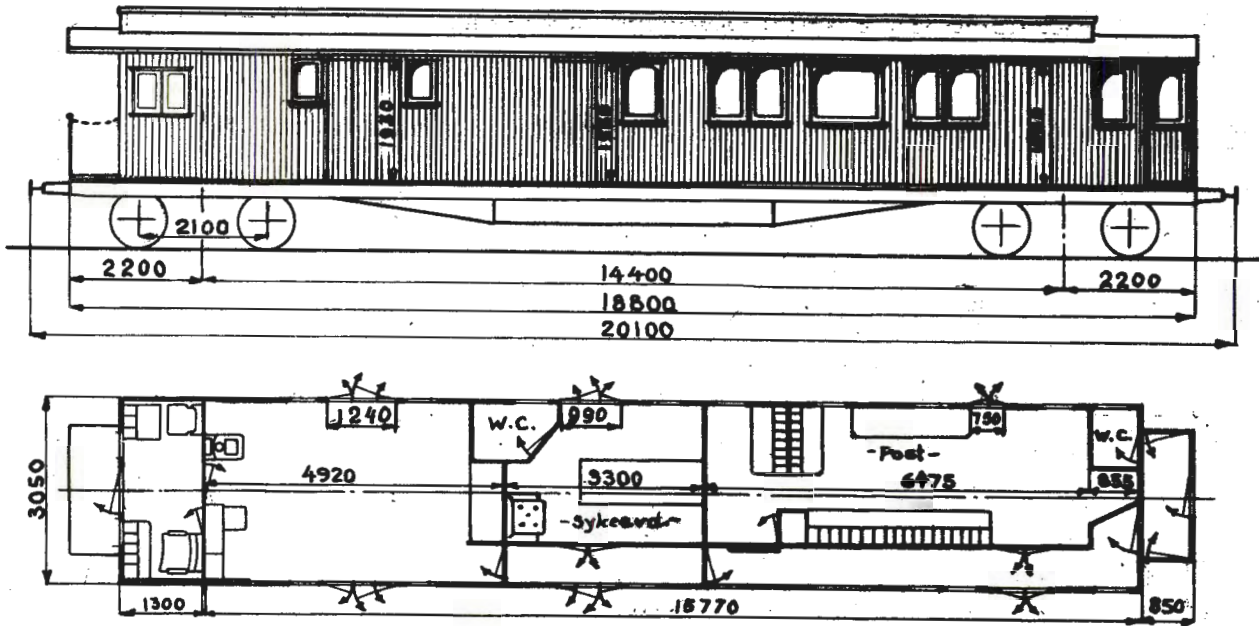

Oppr. hovedt. 989¹⁾

Vogn nr.	Distriktsmerke	Fabrikant	Byggeår	Omtr. vognvekt i tonn	Post, last i tonn	Reisegods, last i tonn	Grunnriss	El. varme i kW	Vognutstyr (se side 6)	Merknad
512	D	Str	09	29,0	2,0	2,0			1H.3.5.8.11.28.39a	
513	"	"	"	28,5	"	"			1H.3.5.8.11.28.39a	

1) Forandr. etter tegn. 4067
Trykk nr. 751 1.7.56

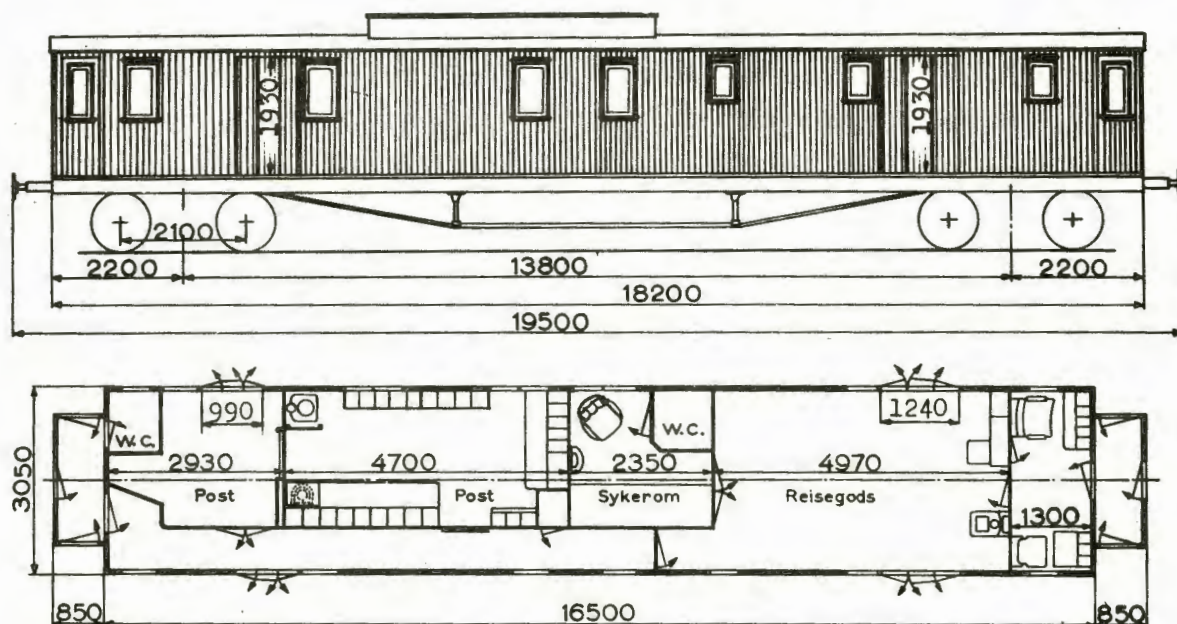
Oppr. hovedt. 829¹⁾

Vogn nr.	Distriktsmerke	Fabrikant	Byggeår	Omr. vognvekt i tonn	Post, last i tonn	Reisegods, last i tonn	Grunnriss	Elvarme i kW	Vognutstyr (se side 6)	Merknad
937	B	Skb	07	28,5	3,0	3,0			1H.3.5.8.11.28 ²⁾ .39a	
938	"	"	"	"	"	"			1H.3.5.8.11.28 ²⁾ .39a	3)
939	"	"	"	"	"	"			1H.3.5.8.11.28 ²⁾ .39a	

1) Forandr. etter tegn. 3482 og Bg. 1528

2) Bare i ende ved konduktörrom

3) Postrom forandr. etter tegn. 8138

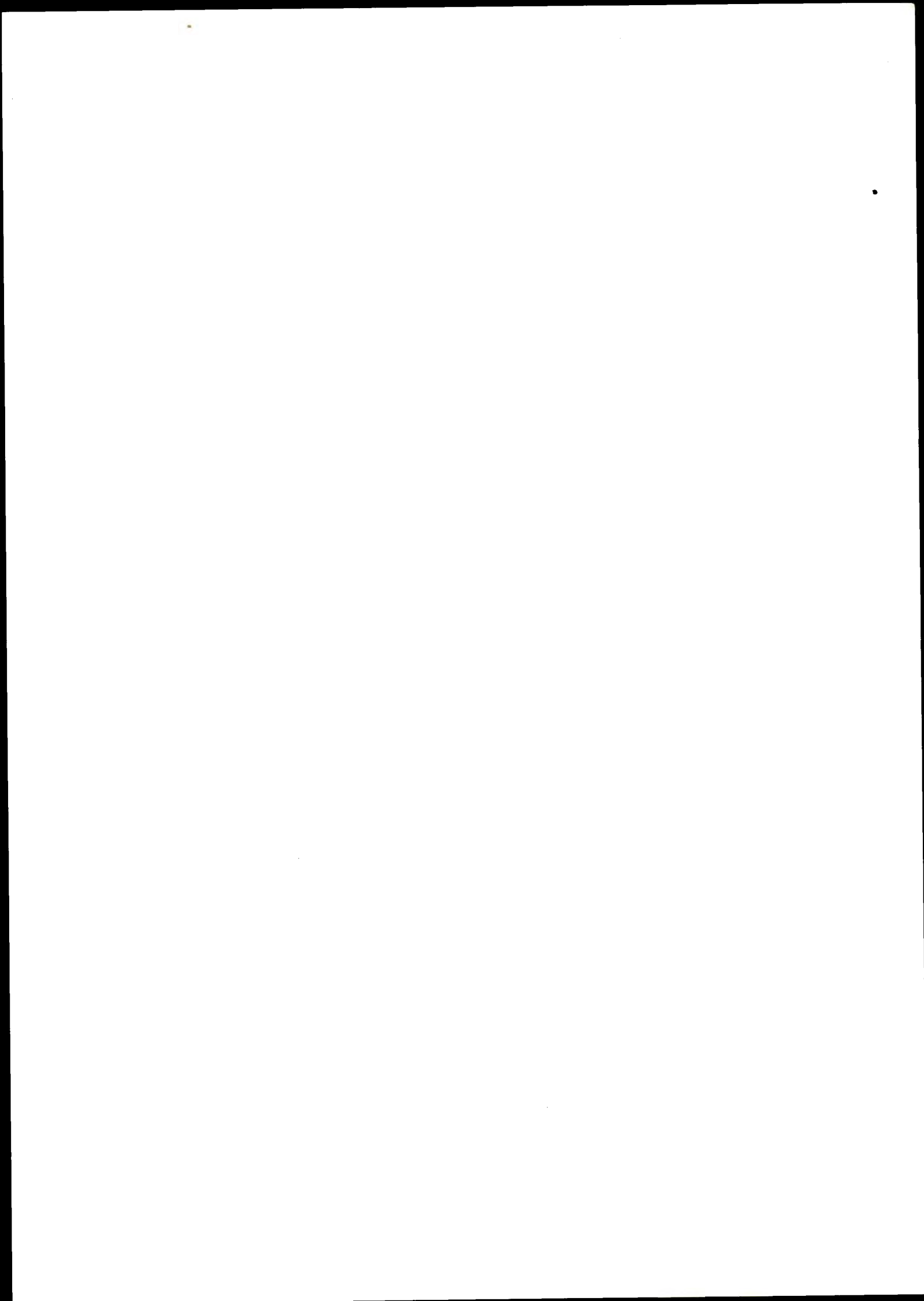

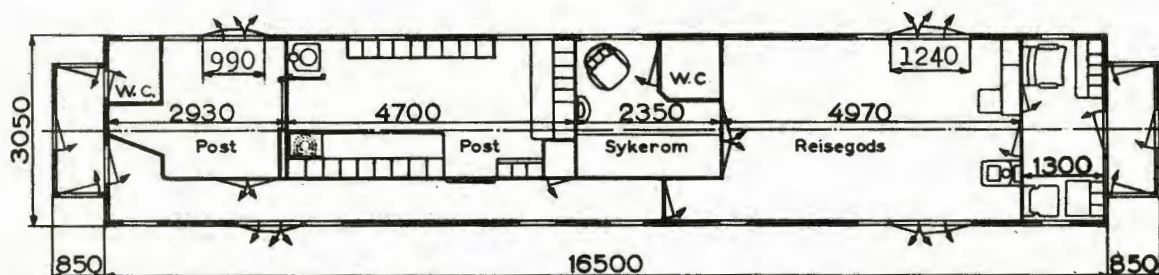
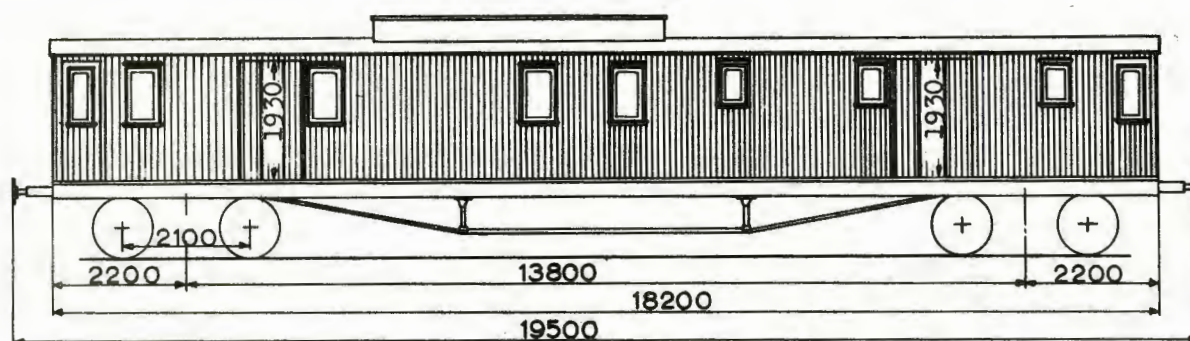
Oppr. hovedt. 829¹⁾

Vogn nr.	Distriktsmerke	Fabrikant	Byggeår	Omr. vognvekt i tonn	Post, last i tonn	Reisegods, last i tonn	Grunnriss	El. varme i kW	Vognutstyr (se side 6)	Merknad
937	B	Skb	07	28,5	3,0	3,0			1H.3.5.8.11.28 ²⁾ .39a	
938	"	"	"	"	"	"			1H.3.5.8.11.28 ²⁾ .39a	
939	"	"	"	"	"	"			1H.3.5.8.11.28 ²⁾ .39a	

1) Forandr. etter tegn. 3482 og Bg. 1528

2) Bare i ende ved konduktørrom

Eo

TYPE 1

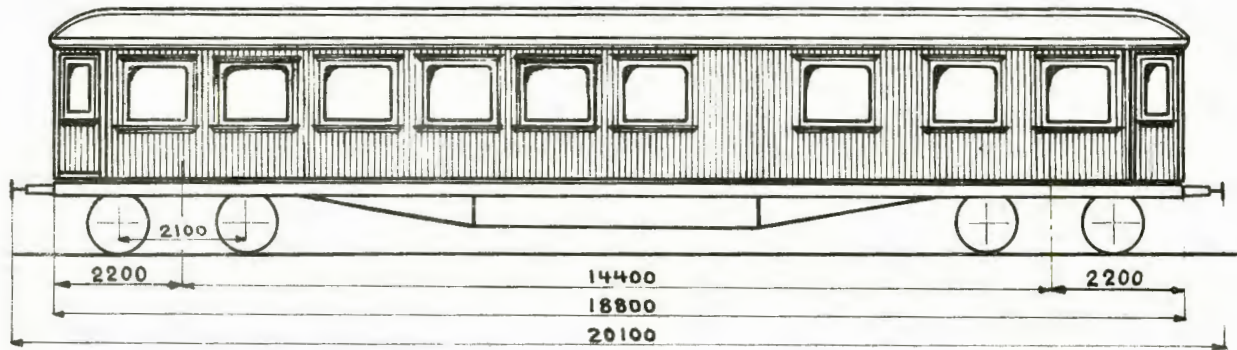

Grunnriss 1

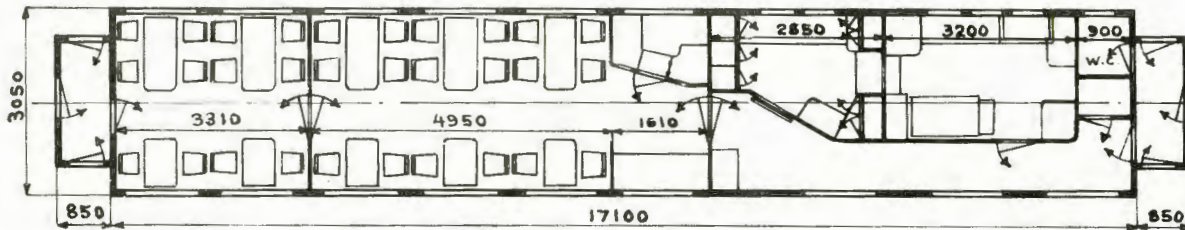

Hovedt. 925

Grunnriss 2

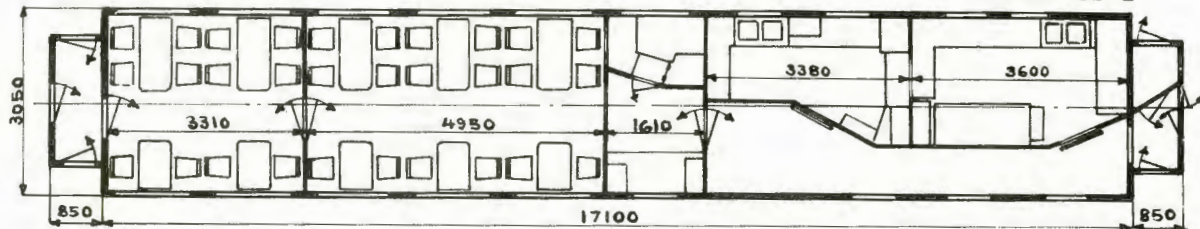

Hovedt. 2068

Vogn nr.	Distriktsmerke	Fabrikant	Byggeår	Omr. vognvekt i tonn	Sittepl.	Grunnriss	El. varme i kW	Vognutstyr (se side 6)	Merknad
944	B	Skb	09	33,0	30	1		1H.3.5.11.28.39a	
945	"	"	"	32,0	"	"		1H.3.5.11.28.39a	
979	"	"	11	33,0	"	2		1H.3.5.11.28.39a	

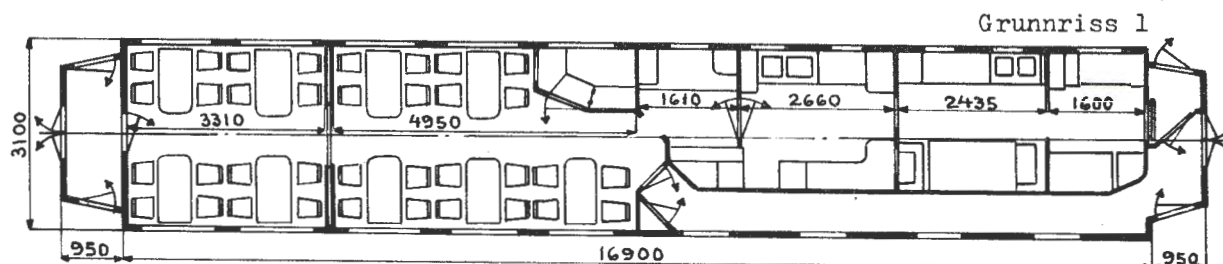
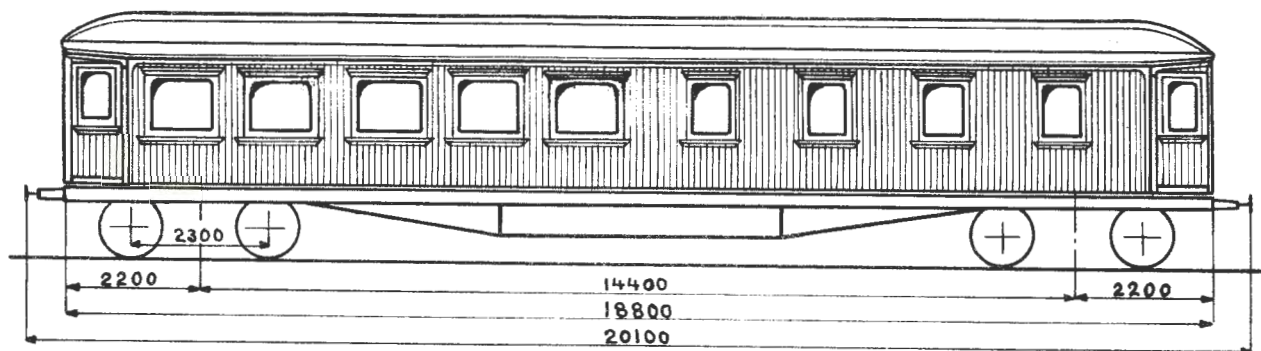

Hovedt. 2115

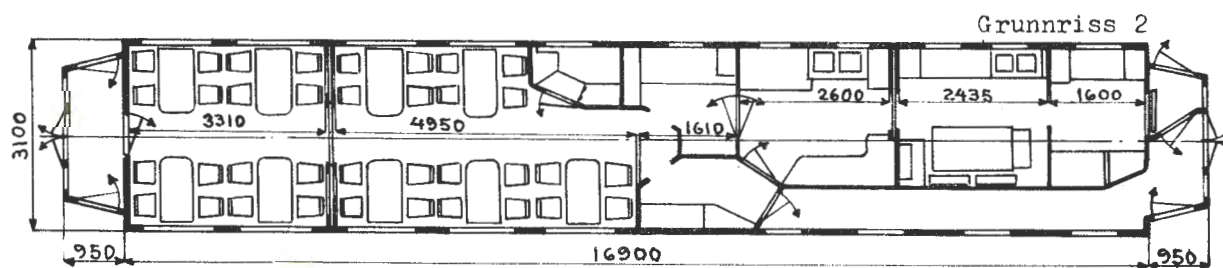

Hovedt. 2679

Vogn nr.	Distriktsmerke	Fabrikanth	Byggeår	Omr. vognvekt i tonn	Sittepl.	Grunnriss	El. varme i kW	Vognutstyr (se side 6)	Merknad
18006	T	Skb	14	34,0	36			1KK.3.5.11.28.39a	
18011	"	"	"	34,5	"			1KK.3.5.11.28.39a	
703	H	"	23	33,0	"			1H.3.5.11.28.39a	

Eo

TYPE 3

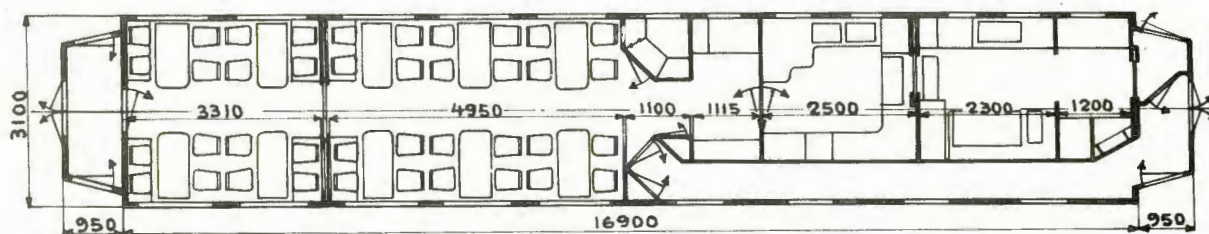
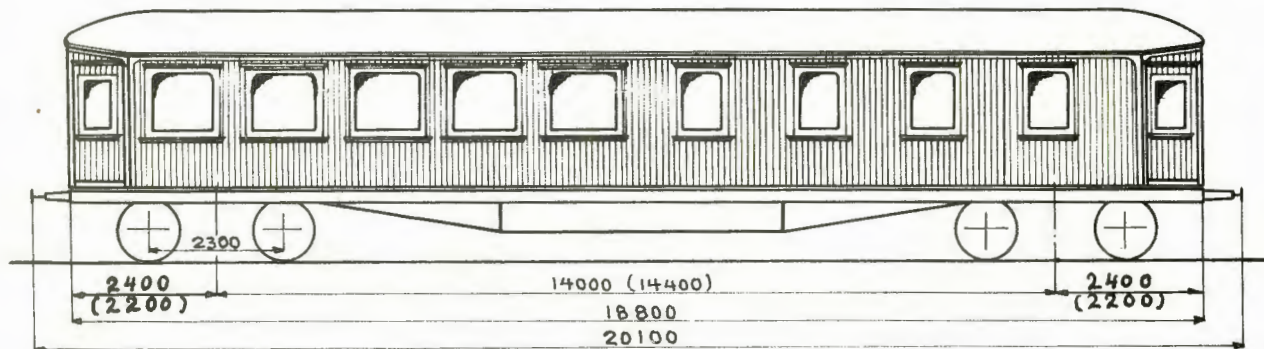

Hovedt. 2975
3265
4230

Vogn nr.	Distriktsmerke	Fabrikant	Byggeår	Omtrentlig vognvekt i tonn	Sittepl.	Grunnriss	Elvarme i kW	Vognutstyr (se side 6)	Merknad
119	O	Skb	26	33,0	40			1H.3.5.11.28.39a	Hovedt. 2975
500	D	"	32	34,0	"			1H.3.5.11.28.39a	" 3265 Stålrørstoler
499	O	"	37	35,5	"			1H.3.5.11.28.39a	" 4230

Mål i () gjelder vogn nr. 119

Trykk nr. 751 1.7.56

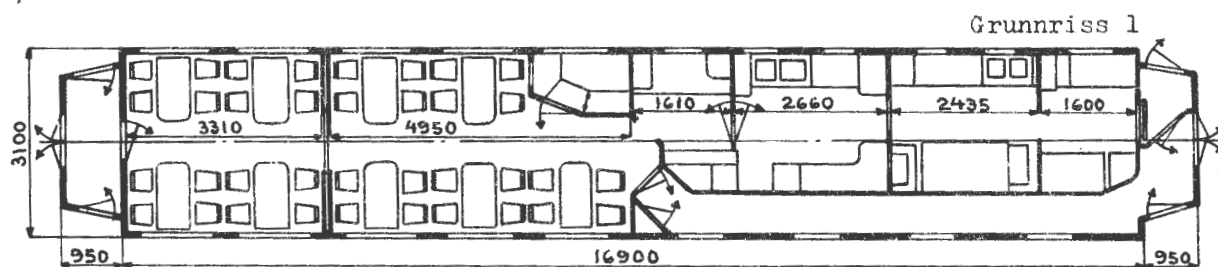
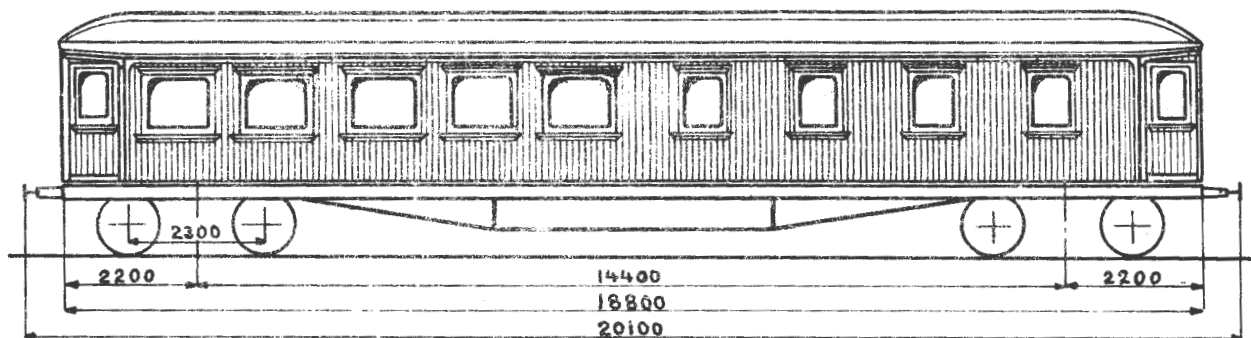

Hovedt. 2115

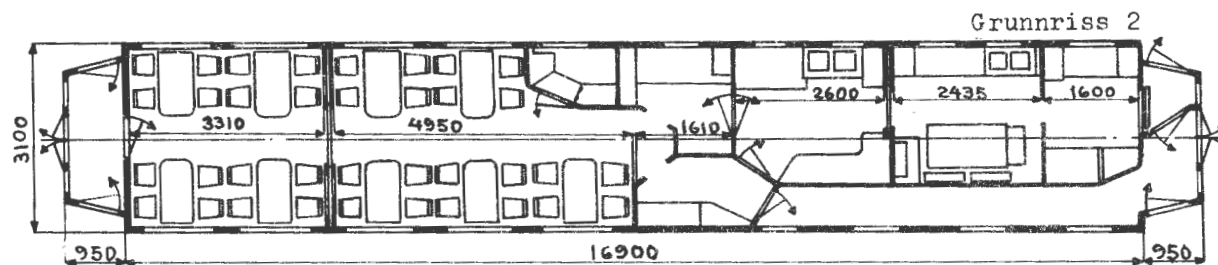

Hovedt. 2679

Vogn nr.	Distriktsmerke	Fabrikant	Byggeår	Omr. vognvekt i tonn	Sittepl.	Grunnriss	El. varme i kW	Vognutstyr (se side 6)	Merknad
703	H	Skb	23	33,0	36	2		1H.3.5.11.28.39a	
18006	T	"	14	34,0	"	1		1KK.3.5.11.28.39a	
18011	"	"	"	34,5	"	"		1KK.3.5.11.28.39a	

Eo

TYPE 3

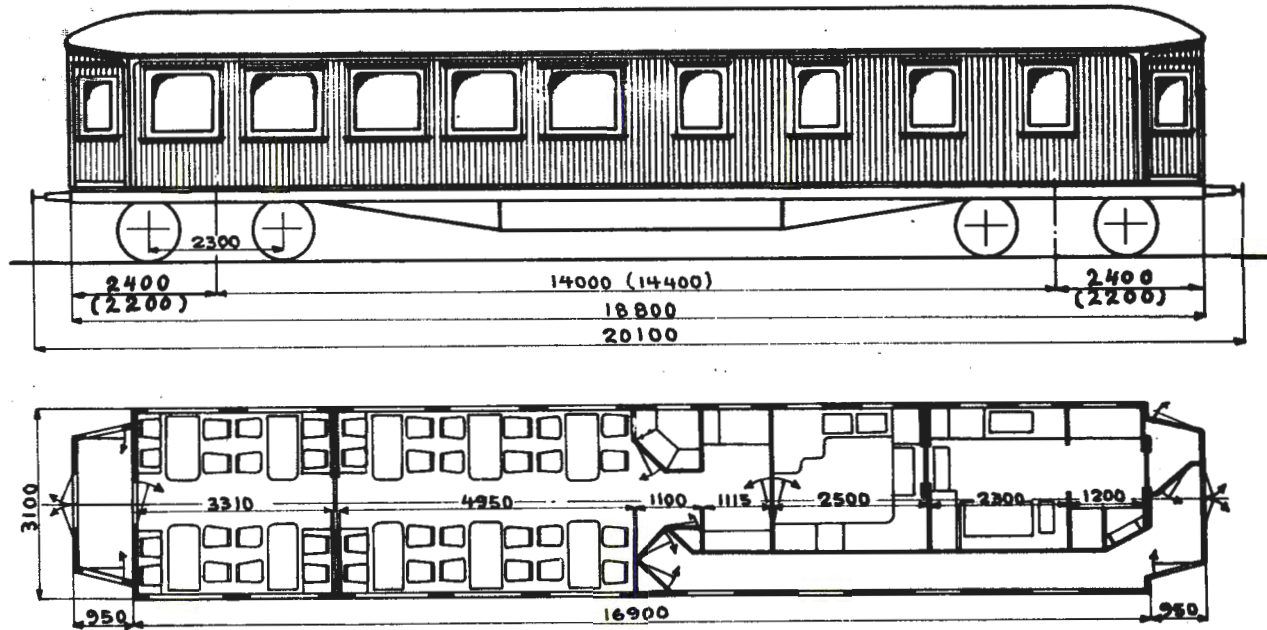

Hovedt. 2975
3265
4230

Vogn nr.	Distriktsmerke	Fabrikant	Byggeår	Omt. vognvekt i tonn	Sittepl.	Grunnriss	El. varme i kW	Vognutstyr (se side 6)	Merknad
119	O	Skb	26	33,0	40			1H.3.5.11.28.39a	Hovedt. 2975
500	D	"	32	34,0	"			1H.3.5.11.28.39a	" 3265
499	O	"	37	35,5	"			1H.3.5.11.28.39a	" 4230

Mål i () gjelder vogn nr. 119

Trykk nr. 751 1.7.58

Eo
 TYPE 4
 Stålvogner

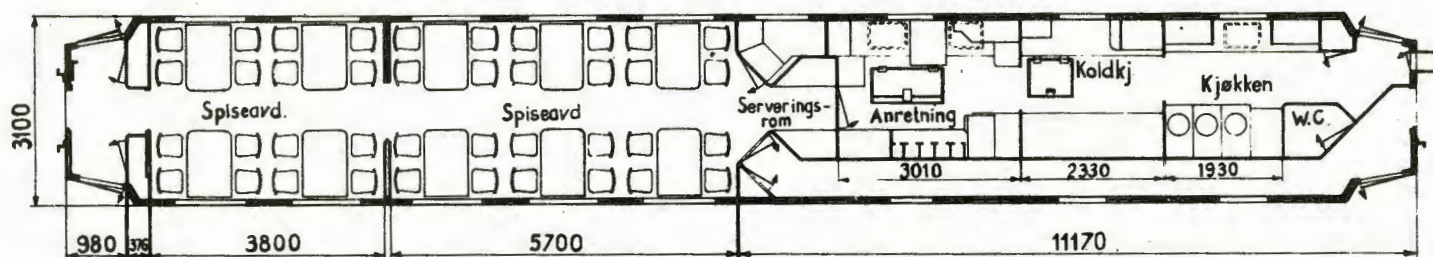
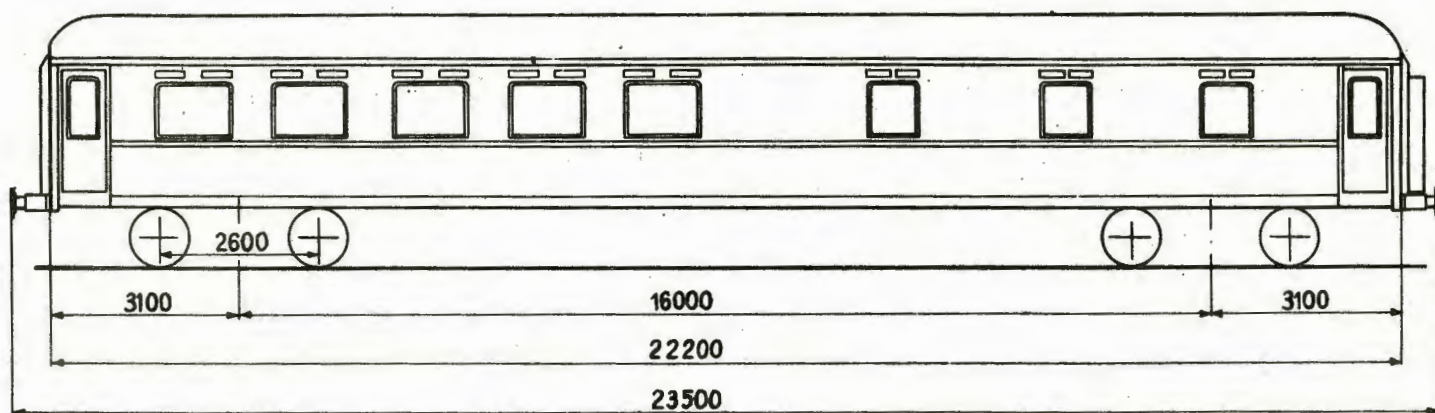

Hovéd. 6045

Vogn nr.	Distriktmerke	Fabrikant	Byggeår	Omr. vognvekt i tonn	Sittepl.	Grunnriss	El. varme i kW	Vognutstyr (se side 6)	Merknad
21251	O	Scd	53	47,5	40	100	1Hs.3.12 ¹⁾ .28.39abc		
21252	"	"	"	"	"	"	1Hs.3.12 ¹⁾ .28.39abc		
21253	D	"	"	"	"	"	1Hs.3.12 ¹⁾ .28.39abc		
21254	"	"	"	"	"	"	1Hs.3.12 ¹⁾ .28.39abc		

1) Omformer

Eo

TYPE 5

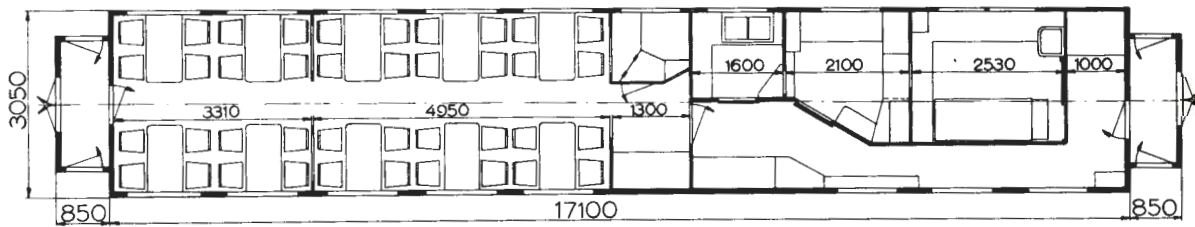
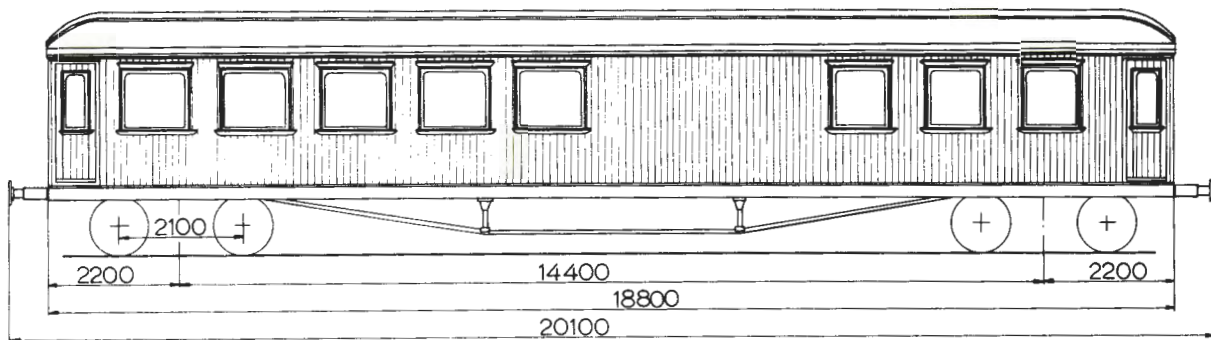

Hovedt. 1116[↓]
2068[↓]

Vogn nr.	Distriktsmerke	Fabrikant	Byggeår	Omr. vognvekt i tonn	Sittepl.	Grunnriss	El. varme i kW	Vognutstyr (se side 6)	Merknad
978	B	Skb	10	32,0	40			1H. 3. 5. 11. 28. 39 a.	
980	"	"	11	32,5	"			1H. 3. 5. 11. 28. 39 a.	

[↓]Forandr. etter skisse 1536

Trykk nr. 751. 1.757

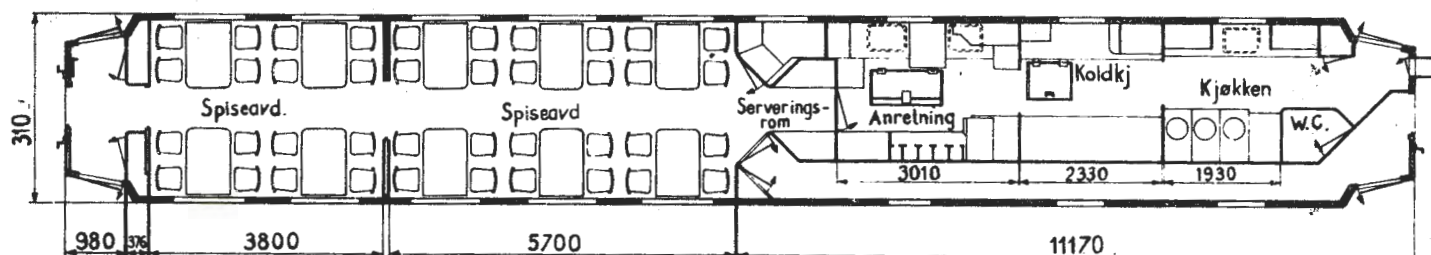
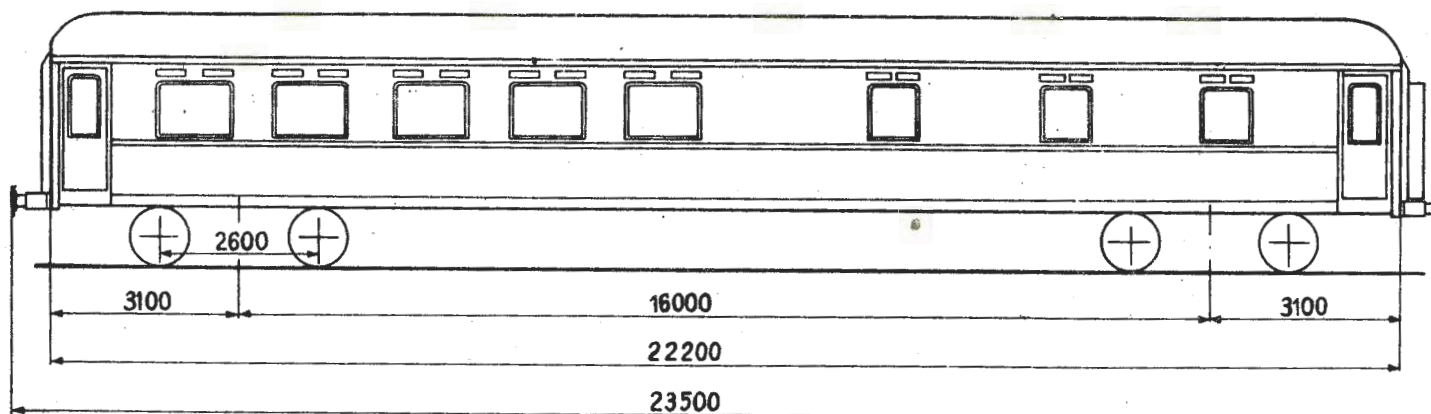

Hovedt. 6045

Vogn nr.	Distriktsmerke	Fabrikant	Byggeår	Omr. vognvekt i tonn	Sittepl.	Grunnriss	El. varme i kW	Vognutstyr (se side 6)	Merknad
21251	0	Scd	53	47,5	40		100	1Hs. 3.12 ¹⁾ .28.39abc	
21252	"	"	"	"	"		"	1Hs. 3.12 ¹⁾ .28.39abc	
21253	D	"	"	"	"		"	1Hs. 3.12 ¹⁾ .28.39abc	
21254	"	"	"	"	"		"	1Hs. 3.12 ¹⁾ .28.39abc	

1) Omformer

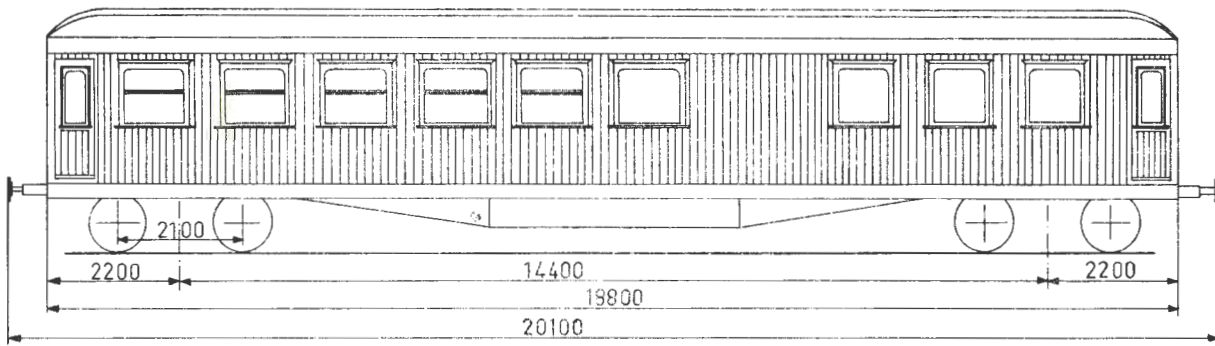

Grunnriss 1

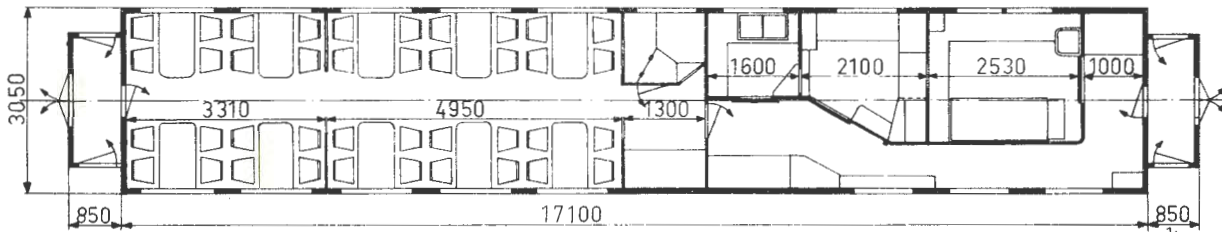

Hovedt. 1116¹⁾

Grunnriss 2

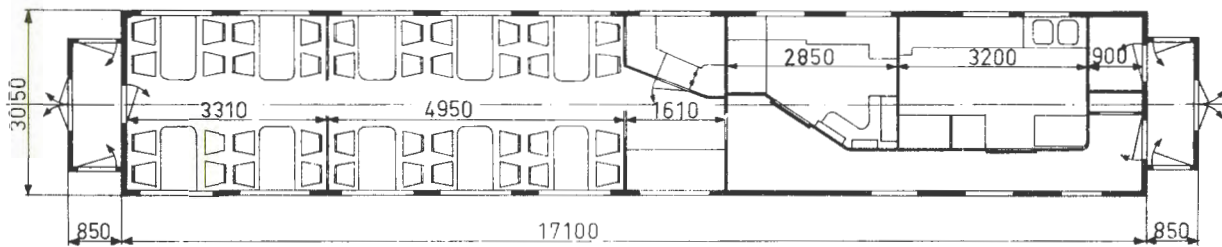

Hovedt. 2068¹⁾²⁾

Grunnriss 3

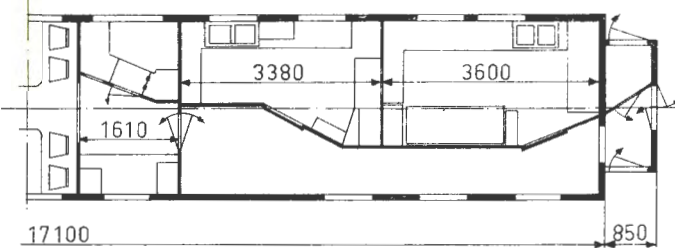

Hovedt. 2068¹⁾

Grunnriss 4

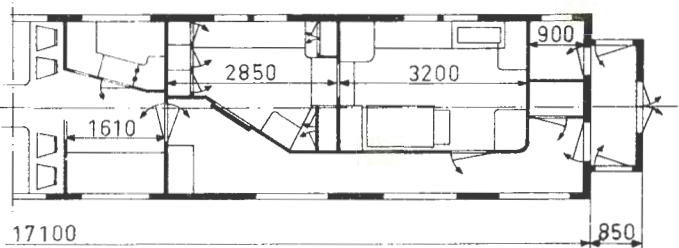

Hovedt. 925¹⁾

Vogn nr.	Distriktsmerke	Fabrikant	Byggeår	Omr. vognvekt i tonn	Sittepl.	Grunnriss	Elvarme i kW	Vognutstyr (se side 6)	Merknad
944	B	Skb	09	33,0	40	4		1H.3.5.11.28.39a	
945	"	"	"	32,0	"	2		1H.3.5.11.28.39a	
978	"	"	10	"	"	1		1H.3.5.11.28.39a	
979	"	"	11	33,0	"	3		1H.3.5.11.28.39a	
980	"	"	"	32,5	"	1		1H.3.5.11.28.39a	

1) Forandr. etter skisse 1536

2) Forandr. etter tegn. 8262, 8263

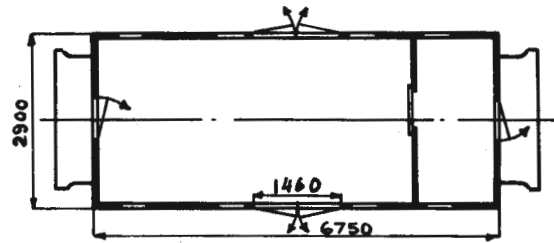
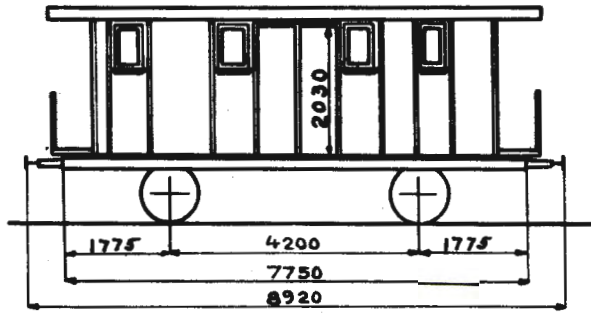

Grunnriss 1
Oppr. hovedt. 81

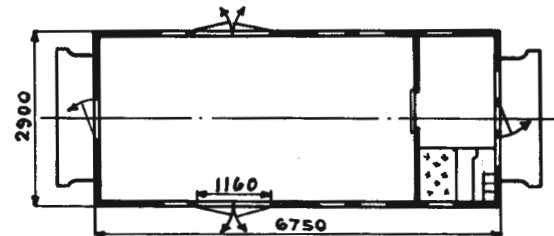

Grunnriss 2
Hovedt. 261

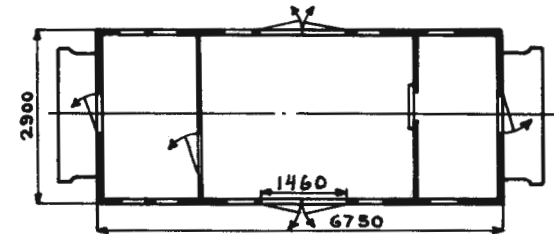

Grunnriss 3
Oppr. hovedt. 81

Vogn nr.	Distriktsmerke	Fabrikant	Byggeår	Omr. vognvekt i tonn	Reisegods, last i tonn	Grunnriss	El.varme i kW	Vognutstyr (se side 6)	Merknad
2001	0	Skb	99	10,5	3,0	1		3.6.8.13.15	
2010	"	KvB	94	9,0	"	2		3.6.8.13.15	
3021	"	Skb	99	9,5	"	3		3.6.8.13.15	

F

TYPE 2

Vogn nr:	Distriktsmerke	Fabrikant	Byggear	Omtr. vognvekt i tonn	Reisegods, last i tonn	Grunnriss	El.varme i kW	Vognutstyr (se side 6)	Merknad
3029	O	KvB	94	9,0	3,0	2		3.6.8.13.15	
5008	H	Skb	"		"	"		3.6.8.13	
7001	O	KvB	"	10,5	0,5	"		3.6.8.13.15	
8002	H	"	"		3,0	"		3.6.8.13	
8003	"	"	"		"	"		3.6.8.13.15	
8005	"	Str	"		"	"		3.6.8.13.15	

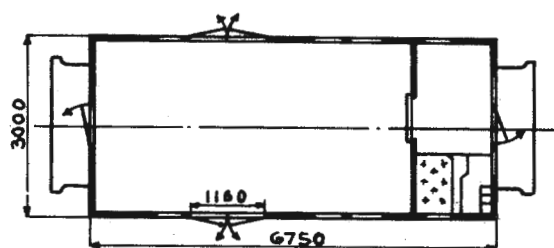
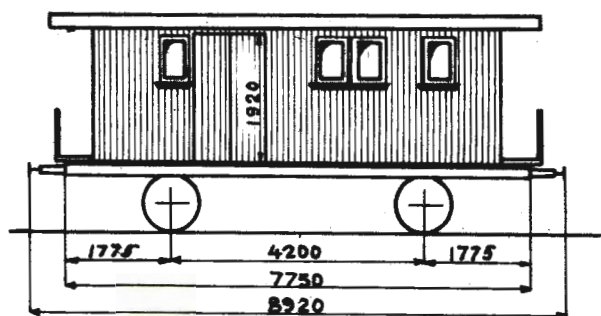

Grunnriss 1
Hovedt. 339

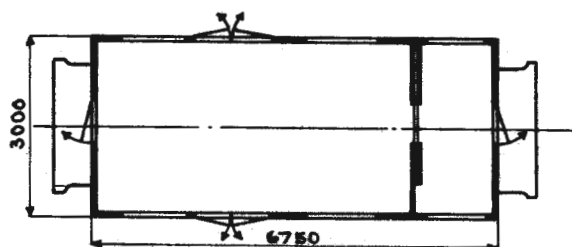

Grunnriss 2

Vogn nr.	Distriktsmerke	Fabrikant	Byggeår	Omr. vognvekt i tonn	Reisegods, last i tonn	Grunnriss	El. varme i kW	Vognutstyr (se side 6)	Merknad
1008	0	Skb	97	8,5	3,0	1		3.5.8.13.15	
2007	=	"	"	9,0	"	2		3.6.8.13.15.24	

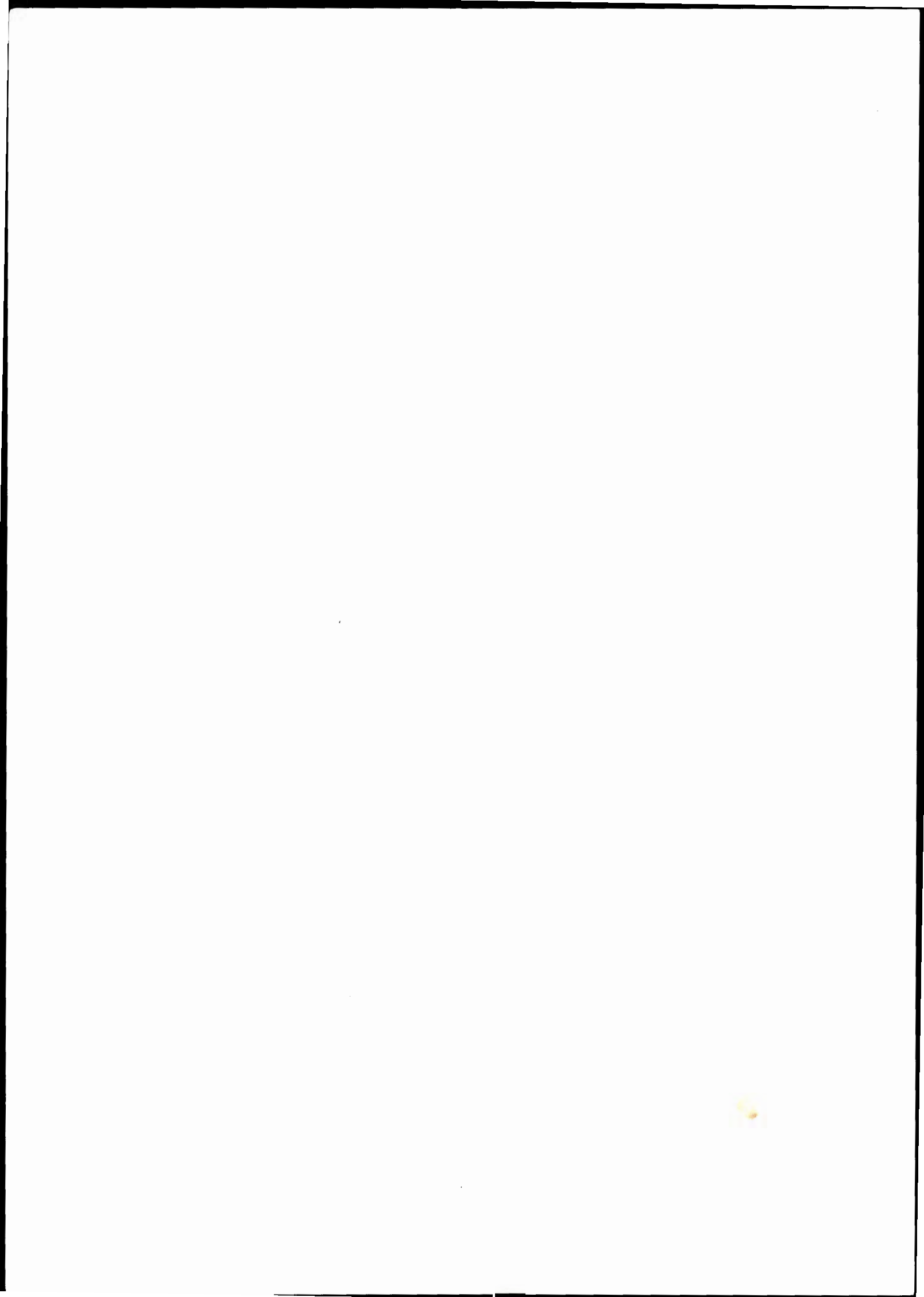

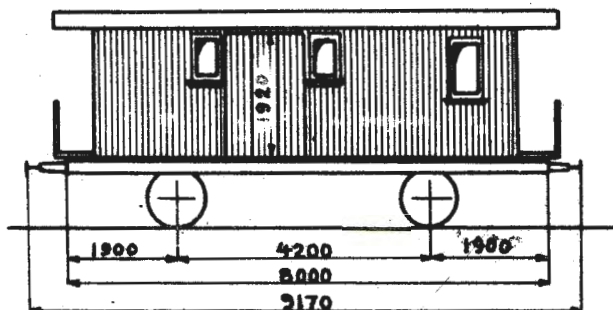

Grunnriss 1
Hovedt. 657

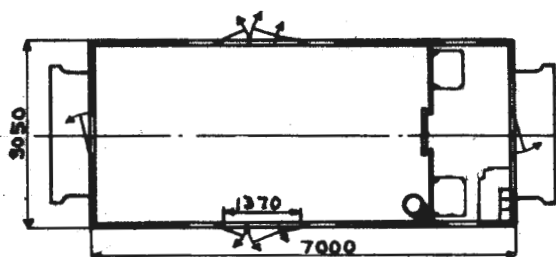

Grunnriss 2
Oppr. hovedt. B. 108

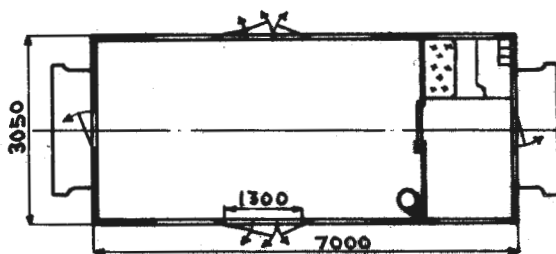

Vogn nr.	Distriktsmerke	Fabrikant	Byggear	Omt. vognvekt i tonn	Re-segods, last i tonn	Grunnriss	El-varme i kW	Vognutstyr (se side 6)	Merknad
1009	0	Str	01	9,5	3,0	2		3.5.8.13.15	
2013	"	"	02	10,0	"	1		3.6.8.13.15	Kond.rom utv. fra 1300 til 1800mm
3560	"	"	"	9,5	"	"		3.6.8.13.15	

F

TYPE 5

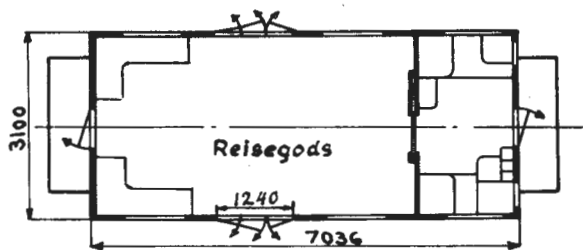
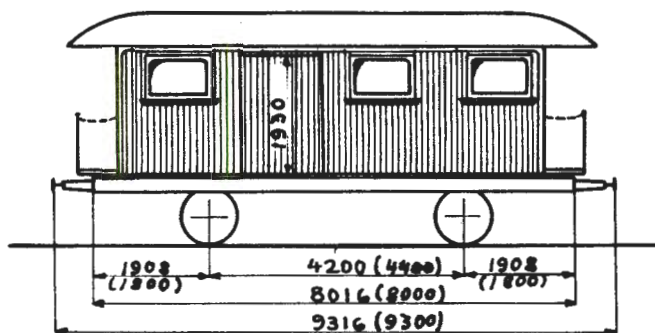

Grunnriss 1
Hovedt. B. 543

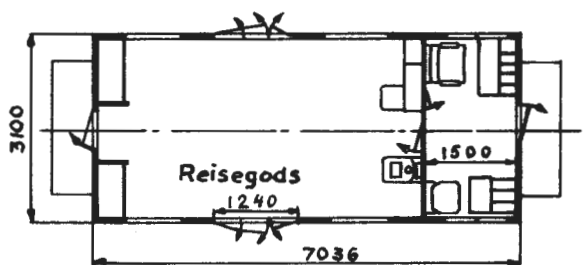

Grunnriss 2
Oppr. hovedt. 478¹⁾
992¹⁾

Vogn nr.	Distriktsmerke	Fabrikant	Byggeår	Omtr. vognvekt i tonn	Reisegods, last i tonn	Grunnriss	El. varme i kW	Vognutstyr (se side 6)	Merknad
1007	0	Skb	97	15,5	0,5	1		3.5.8.13.15	
1010	"	Str	01	15,0	"	"		3.5.8.13.15	
14003	B	"	07	10,5	3,0	2		1H.3.6.8.13.24	2)
15010	D	Skb	09	"	"	"		1H.3.6.8.13.24.40	3)
15011	"	"	"	11,5	"	"		1H.3.6.8.11.24.40	3)

Mål i () gjelder vogner etter grunnriss 2

1) Ny vognkasse etter tegn. 6499

2) Oppr. hovedt. 478

3) " " 992

Trykk nr. 751 1.7.58

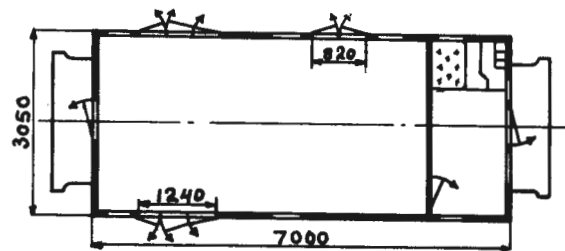
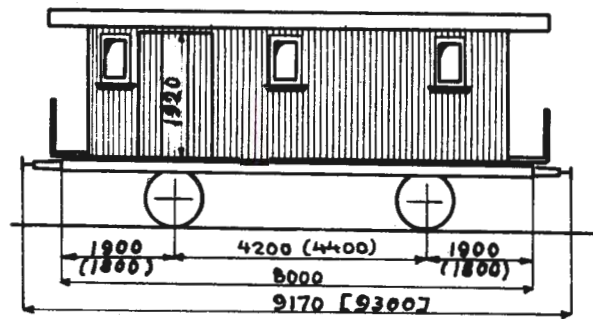

Grunnriss 1
Oppr. hovedt. 478

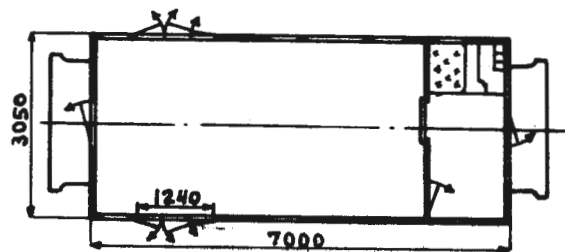

Grunnriss 2
Oppr. hovedt. 478

Vogn nr:	Distriktsmerke	Fabrikant	Byggear	Omr. vognvekt i tonn	Reisegods, last i tonn	Grunnriss	El.varme i kW	Vognutstyr (se side 6)	Merknad
2011	0	Skb	00	9,5	3,0	1		3.6.8.13.15	1)
2012	"	"	"	"	"	"		3.6.8.13.15	
3007	"	"	04	10,0	4,0	2		3.6.8.13.15.24	
3008	"	"	08	9,5	"	"		3.6.8.13.15.24	1)
3554	"	"	00	"	3,0	1		3.6.8.13.15	
3555	"	"	"	9,0	"	"		3.6.8.13.15	1)
3556	"	"	"	9,5	"	"		3.6.8.13.15	
3557	"	"	"	9,0	"	"		3.6.8.13.15	
3558	"	"	01	"	"	"		3.6.8.13.15	
6001	"	"	00	9,5	"	"		3.6.8.13.15	
6002	"	"	"	"	"	"		3.6.8.13.15	1)

1) Konduktörrom utvidet til 1800 mm
Trykk nr. 751 1.7.57

F

TYPE 6

Vogn nr.	Distriktsmerke	Fabrikant	Byggeår	Omtr. vognvekt i tonn	Reisegods, last i tonn	Grunnriss	El-varme i kW	Vognutstyr (se side 6)	Merknad
6003	0	Skb	00	9,5	3,0	1		3.6.8.13.15	1)
6005	"	"	"	9,0	"	"		3.6.8.13.15	1)
6007	"	"	"	"	"	"		3.6.8.13.15	
9003	"	Str	04	10,5	"	"		1H.3.6.8.13.24	
9004	B	Skb	"	10,0	4,0	2		3.6.8.13.15.24	
9006	"	"	"	"	"	"		3.6.8.13.15.24	
12101	T	"	00	9,0	3,0	1		3.6.8.13	
12102	"	"	"	"	"	"		3.6.8.13	
12103	"	"	"	8,5	"	"		3.6.8.13.15	
12104	"	"	"	9,0	"	"		3.6.8.13.15	
14001	B	Str	07	10,0	2,5	"		1H.3.6.8.13.24	
14002	"	"	"	10,5	"	"		1H.3.6.8.13.24	

1) Konduktørrom utvidet til 1800 mm
Mål i () gjelder vogner etter grunnriss 2
Trykk nr. 751 1.7.57

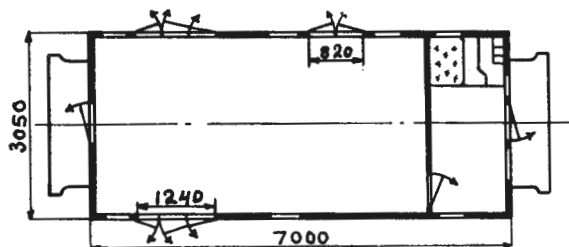
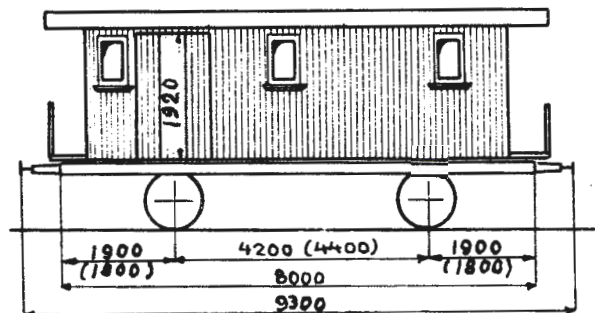

Grunnriss 1
Oppr. hovedt. 478

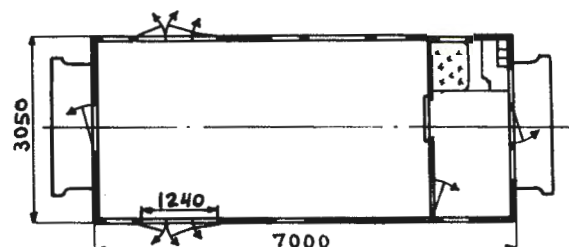

Grunnriss 2
Oppr. hovedt. 478

Vogn nr.	Distriktsmerke	Fabrikant	Byggeår	Omr. vognvekt i tonn	Reisegods, last i tonn	Grunnriss	El-varme i kW	Vognutstyr (se side 6)	Merknad
2011	0	Skb	00	9,5	3,0	1		3.6.8.13.15	1)
2012	"	"	"	"	"	"		3.6.8.13.15	
3007	"	"	04	10,0	4,0	2		3.6.8.13.15.24	
3008	"	"	08	9,5	"	"		3.6.8.13.15.24	
3554	"	"	00	"	3,0	1		3.6.8.13.15	1)
3555	"	"	"	9,0	"	"		3.6.8.13.15	1)
3556	"	"	"	9,5	"	"		3.6.8.13.15	
3557	"	"	"	9,0	"	"		3.6.8.13.15	
3558	"	"	01	"	"	"		3.6.8.13.15	
6001	"	"	00	9,5	"	"		3.6.8.13.15	
6002	"	"	"	"	"	"		3.6.8.13.15	1)

1) Konduktörrom utvidet til 1800 mm
Trykk nr. 751 1.7.58

F

TYPE 6

Vogn nr.	Distriktsmerke	Fabrikant	Byggeår	Omtr. vognvekt i tonn	Reisegods, last i tonn	Grunnriss	El.varme i kW	Vognutstyr (se side 6)	Merknad
6003	0	Skb	00	9,5	3,0	1		3.6.8.13.15	1)
6005	"	"	"	9,0	"	"		3.6.8.13.15	1)
6007	"	"	"	"	"	"		3.6.8.13.15	
9003	"	Str	04	10,5	"	"		1H.3.6.8.13.24	
9004	B	Skb	"	10,0	4,0	2		3.6.8.13.15.24	
9006	"	"	"	"	"	"		3.6.8.13.15.24	
12101	T	"	00	9,0	3,0	1		3.6.8.13	
12102	"	"	"	"	"	"		3.6.8.13	
12103	"	"	"	8,5	"	"		3.6.8.13.15	
12104	"	"	"	9,0	"	"		3.6.8.13.15	
14001	B	Str	07	10,0	2,5	"		1H.3.6.8.13.24	
14002	"	"	"	10,5	"	"		1H.3.6.8.13.24	

1) Konduktörrom utvidet til 1800 mm
Mål i () gjelder vogner etter grunnriss 2
Trykk nr. 751 1.7.57

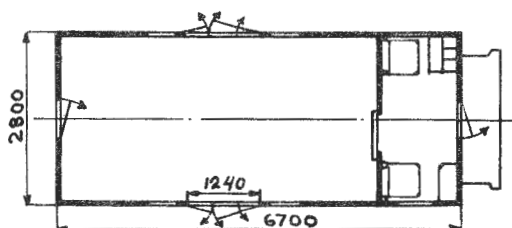
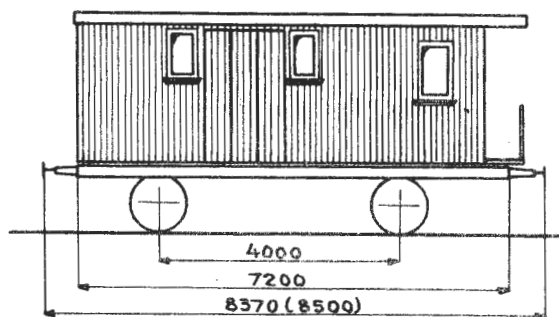

Hovedt. Oslo d. 882

Vogn nr.	Distriktsmerke	Fabrikant	Byggeår	Omr. vognvekt i tonn	Reisegods, last i tonn	Grunnriss	El.varme i kW	Vognutstyr (se side 6)	Merknad
3017	0	Str	82	9,5	3,0			3.8.13.15	} Kond.rom utvidet til 1800 mm
2015	"	AaB	10	9,0	5,0			3.6.8.13.15.24	
2016	"	"	"	"	0,5			3.6.8.13.15.24	} Kond.rom utvidet til 1800 mm
2017	"	"	"	"	5,0			3.6.8.13.15.24	
2018	"	"	"	9,5	"			3.6.8.13.15.24	
2019	"	"	"	"	"			3.6.8.13.15.24	
2020	"	"	"	"	"			1H.3.6.8.13.24	
2021	"	"	"	10,0	5,0			1H.3.6.8.13.24	} Kond.rom utvidet til 1800 mm

F

TYPE 8

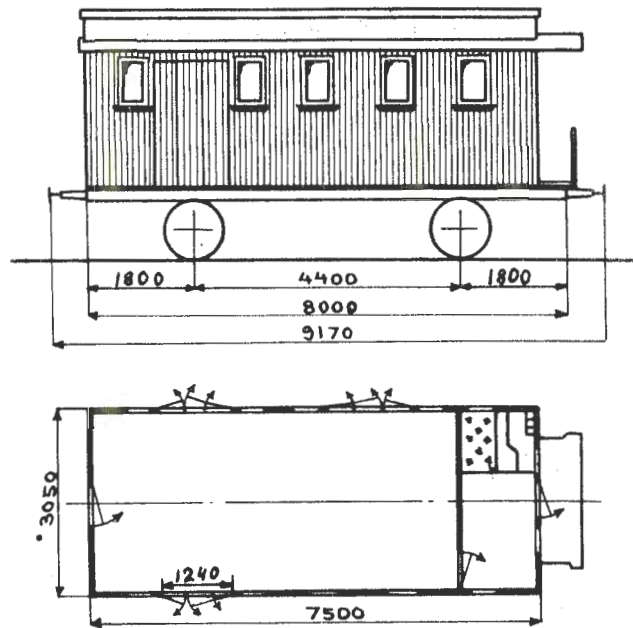

Hovedt. 992

Vogn nr.	Distriktsmerke	Fabrikant	Byggeår	Omtr. vognvekt i tonn	Reise gods, last i tonn	Grunnriss	El. varme i kW	Vognutstyr (se side 6)	Merknad
6008	0	Skb	09	10,0	3,0			3.6.8.13.15.24	
9007	B	"	"	"	"			3.6.8.13.15.24	
14005	"	"	"	10,5	"			3.6.8.13.15.24	
14006	"	"	"	11,0	"			3.6.8.13.15.24	
14007	"	"	"	10,5	"			1H.3.6.8.13.24	
14008	"	"	"	"	"			1H.3.6.8.13.24.40	
14009	"	"	"	10,0	"			3.6.8.13.15.24	
15008	"	"	"	"	"			1H.3.6.8.13.24.40	
15009	D	"	"	10,5	"			1H.3.6.8.13.24.40	
15011	"	"	"	"	"			1H.3.6.8.13.24.40	
15012	"	"	"	10,0	"			1H.3.6.8.13.24.40	Instruksjonsvogn for bremses
7005	0	"	10	9,5	"			3.6.8.13.15.24	
7006	"	"	"	10,0	"			3.6.8.13.15.24	
5009	H	"	11	9,5	"			3.6.8.13.15.24	
15013	K	"	"	10,5	"			1H.3.6.8.13.24.40	
15014	D	"	"	10,0	"			1H.3.6.8.13.24.39a	
15015	"	"	"	13,5	"			1H.3.6.8.13.24	
15016	"	"	"	13,0	"			1H.3.6.13.24	

Trykk nr. 751 1.7.56

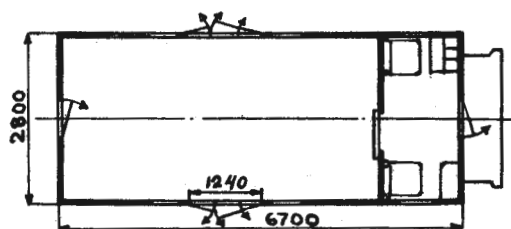
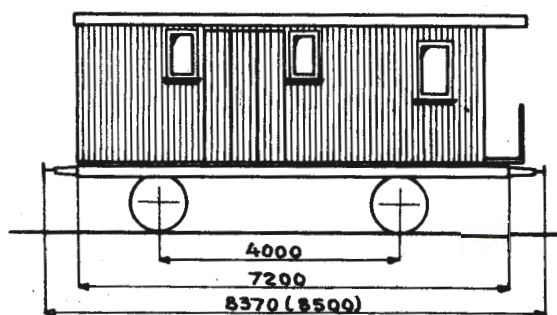

Hovedt. Oslo d. 882

Vogn nr.	Distriktsmerke	Fabrikant	Byggeår	Omr. vognvekt i tonn	Reisegods, last i tonn	Grunnriss	El.varme i kW	Vognutstyr (se side 6)	Merknad
3017	0	Str	82	9,5	3,0			3.8.13.15	} Kond.rom utvidet til 1800 mm
2015	"	AaB	10	9,0	5,0			3.6.8.13.15.24	
2016	"	"	"	"	0,5			3.6.8.13.15.24	
2017	"	"	"	"	5,0			3.6.8.13.15.24	} Kond.rom utvidet til 1800 mm
2018	"	"	"	9,5	"			3.6.8.13.15.24	
2019	"	"	"	"	"			3.6.8.13.15.24	} Kond.rom utvidet til 1800 mm
2020	"	"	"	"	"			1H.3.6.8.13.24	
2021	"	"	"	10,0	5,0			1H.3.6.8.13.24	

F

TYPE 8

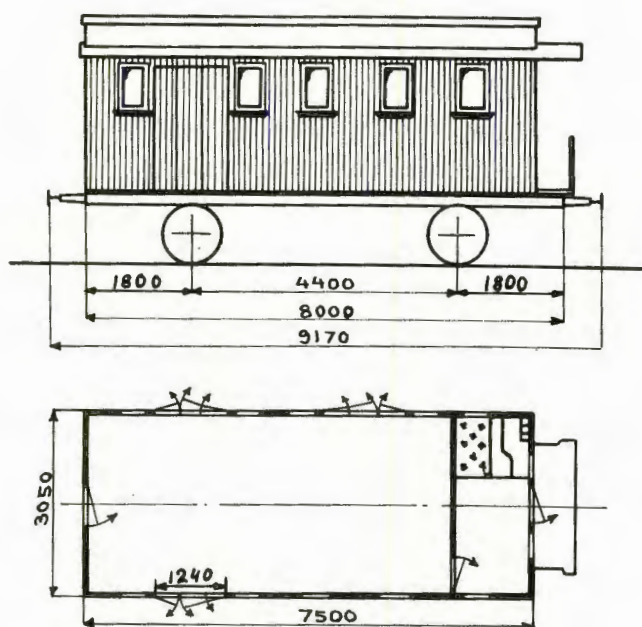

Hovedt. 992

Vogn nr	Distriktsmerke	Fabrikant	Byggeår	Omr. vognvekt i tonn	Reisegods, last i tonn	Grunnriss	El. varme i kW	Vognutstyr (se side 6)	Merknad
5009	H	Skb	11	9,5	3,0			3.6.8.13.15.24	
6008	O	"	09	10,0	"			3.6.8.13.15.24	
7005	"	"	10	9,5	"			3.6.8.13.15.24	
7006	"	"	"	10,0	"			3.6.8.13.15.24	
9007	B	"	09	"	"			3.6.8.13.15.24	
14005	"	"	"	10,5	"			3.6.8.13.15.24	
14006	"	"	"	11,0	"			3.6.8.13.15.24	
14007	"	"	"	10,5	"			1H.3.6.8.13.24	
14008	"	"	"	"	"			1H.3.6.8.13.24.40	
14009	"	"	"	10,0	"			3.6.8.13.15.24	
15008	D	"	"	10,5	"			1H.3.6.8.13.24.40	
15009	"	"	"	"	"			1H.3.6.8.13.24.40	
15011	"	"	"	"	"			1H.3.6.8.13.24.40	
15012	"	"	"	"	"			1H.3.6.8.13.24.40	Instruksjonsvogn for bremsar
15013	K	"	11	"	"			1H.3.6.8.13.24.40	
15014	D	"	"	"	"			1H.3.6.8.13.24.39a	
15015	"	"	"	13,5	"			1H.3.6.8.13.24	
15016	"	"	"	13,0	"			1H.3.6.13.24	

Trykk nr. 751 1.7.57

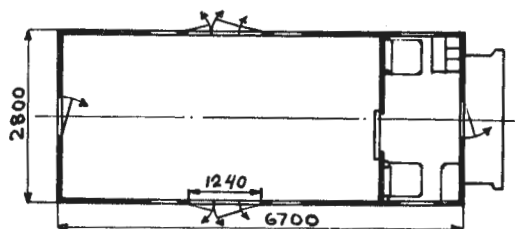
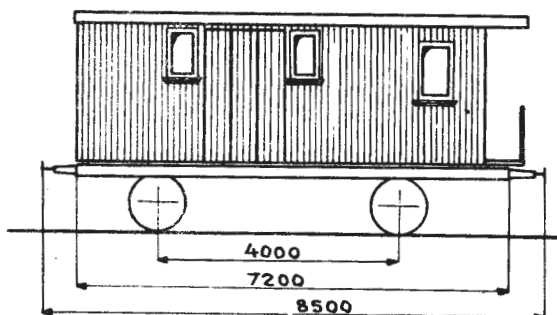

Hovedt. Oslo d. 882

Vogn nr.	Distriktsmerke	Fabrikant	Byggeår	Omr. vognvekt i tonn	Reisegods, last i tonn	Grunnriss	El.varme i kW	Vognutstyr (se side 6)	Merknad
2015	0	AaB	10	9,0	5,0			3.6.8.13.15.24	1)
2016	"	"	"	"	0,5			3.6.8.13.15.24	
2017	"	"	"	"	5,0			3.6.8.13.15.24	1)
2018	"	"	"	9,5	"			3.6.8.13.15.24	
2019	"	"	"	"	"			3.6.8.13.15.24	
2020	"	"	"	"	"			1H.3.6.8.13.24	
2021	"	"	"	10,0	"			1H.3.6.8.13.24	1)
3017	"	Str	82	9,5	3,0			3.8.13.15	1)

1) Kond.rom utvidet til 1800 mm
Trykk nr. 751 1.7.58

F

TYPE 8

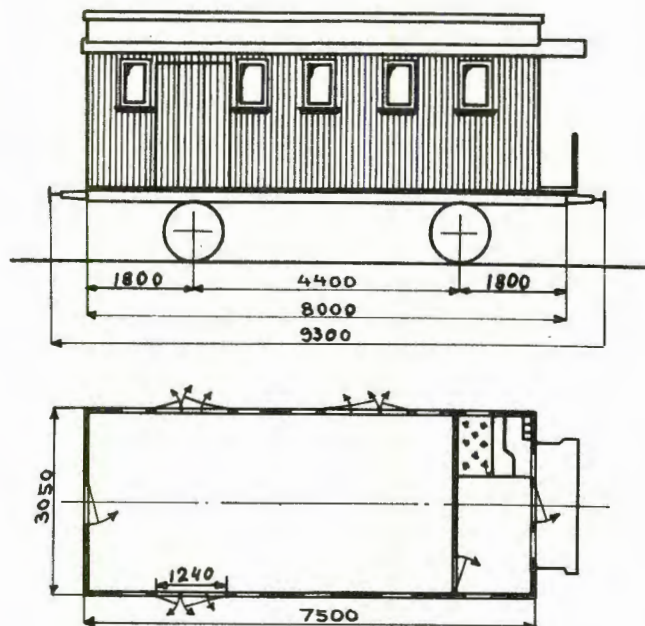

Hovedt. 992

Vogn nr.	Distriktsmerke	Fabrikant	Byggeår	Omr. vognvekt i tonn	Reisegods, last i tonn	Grunnriss	El. varme i kW	Vognutstyr (se side 6)	Merknad
5009	H	Skb	11	9,5	3,0			3.6.8.13.15.24	
6008	O	"	09	10,0	"			3.6.8.13.15.24	
7005	"	"	10	9,5	"			3.6.8.13.15.24	
7006	"	"	"	10,0	"			3.6.8.13.15.24	
14005	B	"	09	10,5	"			3.6.8.13.15.24.40	
14006	"	"	"	11,0	"			3.6.8.13.15.24	
14007	"	"	"	10,5	"			1H.3.6.8.13.24	
14008	"	"	"	"	"			1H.3.6.8.13.24.40	
14009	"	"	"	10,0	"			3.6.8.13.15.24	
15008	D	"	"	10,5	"			1H.3.6.8.13.24.40	
15009	"	"	"	"	"			1H.3.6.8.13.24.40	
15012	"	"	"	"	"			1H.3.6.8.13.24.40	1)
15013	K	"	11	"	"			1H.3.6.8.13.24.40	
15014	D	"	"	"	"			1H.3.6.8.13.24.39a	
15015	"	"	"	13,5	"			1H.3.6.8.13.24	
15016	"	"	"	13,0	"			1H.3.6.13.24	

1) Instruksjonsvogn for bremsar
Trykk nr. 751 1.7.58

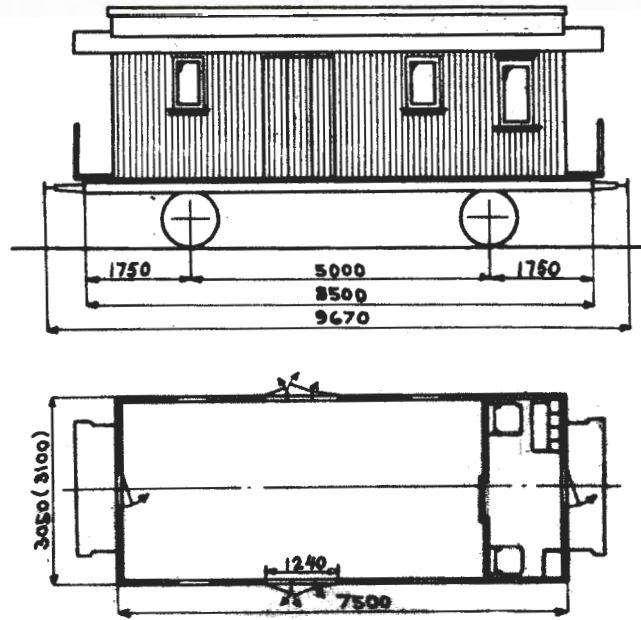

Hovadt. 1254

Vogn nr.	Distriktsmerke	Fabrikant	Byggeår	Omtr. vognvækt i tonn	Reisegods, last i tonn	Grunnriss	El. varme i kW	Vognutstyr (se side 6)	Merknad
6010	0	Skb	12	12,0	2,0			1H.3.6.8.13.24.39a	
6011	"	"	"	11,5	3,0			1H.3.6.8.13.24	Kond.rom utvidet til 1800 mm
3009	"	Str	13	11,0	"			1H.3.6.8.13.24	
3010	"	"	"	"	"			1H.3.6.8.13.24	Kond.rom utvidet til 1800 mm
3011	"	"	"	"	"			1H.3.6.8.13.24	
3012	"	"	"	"	"			1H.3.6.8.13.24	
6012	"	"	"	11,5	"			1H.3.6.8.13.24	
6013	"	"	"	"	"			1H.3.6.8.13.24	

F

TYPE 10

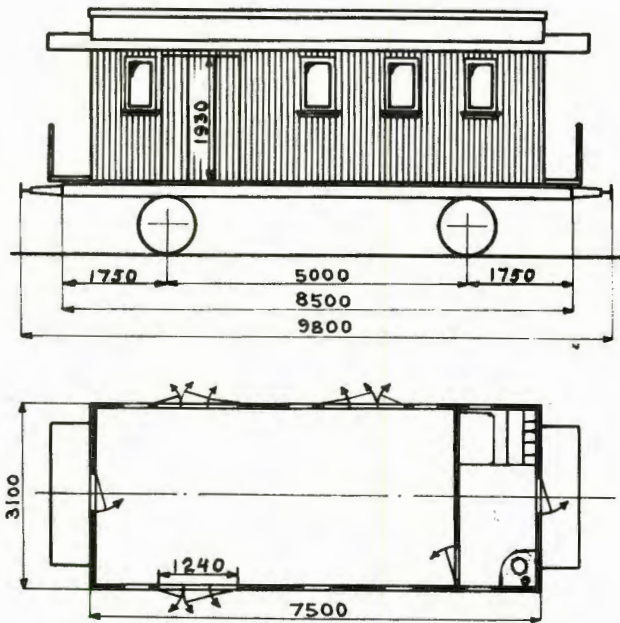

Hovedt. 1930
2104

Vogn nr.	Distriktsmerke	Fabrikant	Byggeår	Omr. vognvekt i tonn	Reisegods, last i tonn	Grunnriss	El.varme i kW	Vognutstyr (se side 6)	Merknad
2022	0	Str	13	13,5	3,0			1H.3.6.8.13.24	
2024	"	Skb	19	"	"			1H.3.6.8.13.24	
3030	"	"	"	11,0	"			1H.3.6.8.13.24	
3031	"	"	"	14,0	"			1H.3.6.8.13.24	
3032	"	"	"	11,5	"			1H.3.6.8.13.24	1)
5012	H	"	"	"	"			1H.3.6.8.13.24	
5013	"	"	"	13,5	"			1H.3.6.8.13.24	
5014	"	"	"	11,0	"			1H.3.6.8.13.24	
5015	"	"	"	13,5	"			1H.3.6.8.13.24	
5016	"	"	"	10,5	"			1H.3.6.8.13.24	
5634	T	Str	14	11,0	"			1H.3.5 ²⁾ .8.13.24	
5635	"	"	"	10,5	"			1H.3.6.8.13.24	
6014	0	Skb	19	11,5	"			1H.3.6.8.13.24	1)
6015	"	"	"	14,0	"			1H.3.6.8.13.24	
6016	"	"	"	13,5	"			1H.3.6.8.13.24	
6025	"	"	13	8,0	"			1H.3.6.8.13.24	1)
14010	B	"	15	12,0	2,0			1H.3.6.8.13.24.40	1)
14011	"	"	19	"	"			1H.3.6.8.13.24.40	
14012	"	"	"	"	"			1H.3.6.8.13.24.39a	Utstyr for 32 volts lys fra nabovogn eller lok.

1) Hovedt. 1930
2) Bare i godsrom
Trykk nr. 751 1.7.57

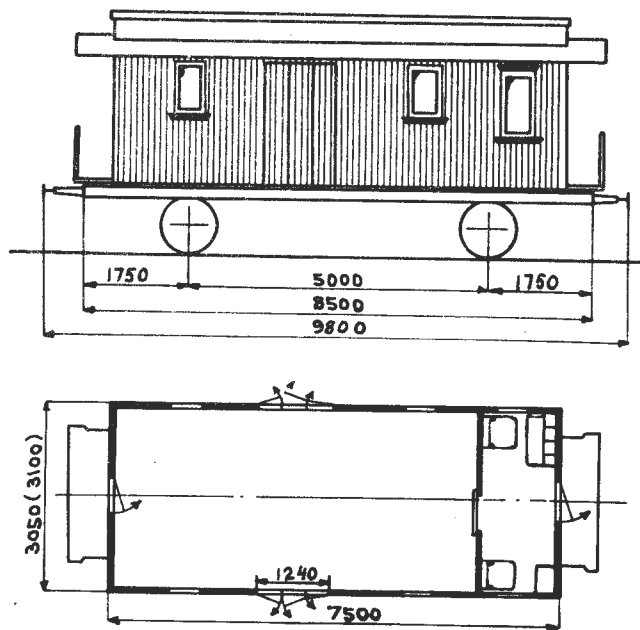

Hovedt. 1254

Vogn nr.	Distriktsmerke	Fabrikant	Byggeår	Omr. vognvekt i tonn	Reisegods, last i tonn	Grunnriss	El. varme i kW	Vognutstyr (se side 6)	Merknad
3009	0	Str	13	11,0	3,0			1H.3.6.8.13.24	
3010	"	"	"	"	"			1H.3.6.8.13.24	
3011	"	"	"	"	"			1H.3.6.8.13.24	1)
3012	"	"	"	"	"			1H.3.6.8.13.24	1) 2)
6010	"	Skb	12	12,0	2,0			1H.3.6.8.13.24.39a	
6011	"	"	"	11,5	3,0			1H.3.6.8.13.24	2)
6012	"	Str	13	"	"			1H.3.6.8.13.24	2)
6013	"	"	"	"	"			1H.3.6.8.13.24	

1) Kond.rom etter tegn. 6061
 2) Kond.rom utvidet til 1800 mm
 Trykk nr. 751 1.7.58

F

TYPE 10

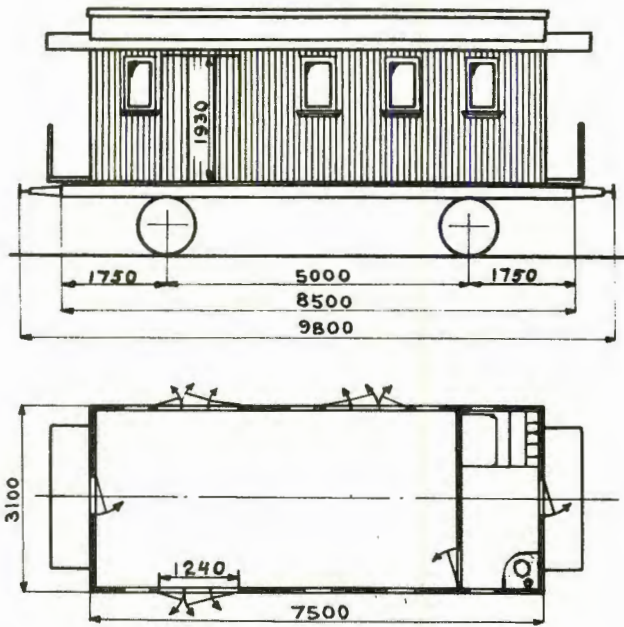

Hovedt. 1930
2104

Vogn nr.	Distriktsmerke	Fabrikant	Byggeår	Omr. vognvekt i tonn	Reisegods, last i tonn	Grunnriss	El-varme i kW	Vognutstyr (se side 6)	Merknad
2022	O	Str	13	13,5	3,0			1H.3.6.8.13.24	
2024	"	Skb	19	"	"			1H.3.6.8.13.24	
3030	"	"	"	11,0	"			1H.3.6.8.13.24	
3031	"	"	"	14,0	"			1H.3.6.8.13.24	
3032	"	"	"	11,5	"			1H.3.6.8.13.24	1)
5012	H	"	"	"	"			1H.3.6.8.13.24	
5013	"	"	"	13,5	"			1H.3.6.8.13.24	
5014	"	"	"	11,0	"			1H.3.6.8.13.24	
5015	"	"	"	13,5	"			1H.3.6.8.13.24	
5016	"	"	"	10,5	"			1H.3.6.8.13.24	
5634	T	Str	14	11,0	"			1H.3.5 ²).8.13.24	
5635	"	"	"	10,5	"			1H.3.6.8.13.24	3)
6014	O	Skb	19	11,5	"			1H.3.6.8.13.24	1)
6015	"	"	"	14,0	"			1H.3.6.8.13.24	
6016	"	"	"	13,5	"			1H.3.6.8.13.24	
6025	"	"	13	8,0	"			1H.3.6.8.13.24	1)
14010	B	"	15	12,0	2,0			1H.3.6.8.13.24.40	1)
14011	"	"	19	"	"			1H.3.6.8.13.24.40	
14012	"	"	"	"	"			1H.3.6.8.13.24.39a	4)

1) Hovedt. 1930

2) Bare i godsrom

3) Kond.rom etter tegn. 6061

4) Utstyr for 32 volts lys fra nabovg. eller lok.

Trykk nr. 751 1.7.58

Vogn nr:	Distriktsmerke	Fabrikant	Byggear	Omtr. vognvekt i tonn	Reisegods, last i tonn	Grunnriss	El.varme i kW	Vognutstyr (se side 6)	Merknad
6014	0	Skb	19	11,5	3,0			1H.3.6.8.13.24	Hovedt. 1930
6015	"	"	"	14,0	"			1H.3.6.8.13.24	
6016	"	"	"	13,5	"			1H.3.6.8.13.24	
14011	B	"	"	12,0	2,0			1H.3.6.8.13.24.40	
14012	"	"	"	"	"			1H.3.6.8.13.24.40	
15017	D	"	"	14,0	3,0			1H.3.6.8.13.24	
17953	T	"	"	11,0	"			1H.3.6.8.13.24	Hovedt. 1930
17954	"	"	"	"	"			1H.3.6.8.13.24	
17955	"	"	"	"	"			1H.3.5 ¹).8.13.24	

F

TYPE 11

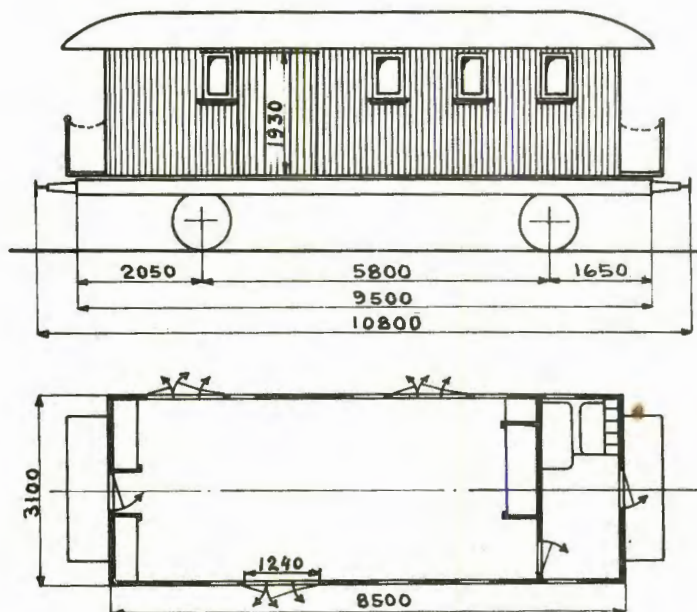

Hovedt. 2531
2558

Vogn nr.	Distriktsmerke	Fabrikant	Byggeår	Omr. vognvekt i tonn	Reisegods, last i tonn	Grunnriss	El. varme i kW	Vognutstyr (se side 6)	Merknad
2025	0	Str	22	12,5	6,0			1H.3.6.8.13.24	
2026	"	"	"	"	"			1H.3.6.8.13.24	Kond.rom utvidet til 1800 mm
2027	"	"	"	12,0	"			1H.3.6.8.13.24	
2028	"	"	"	12,5	"			1H.3.6.8.13.24	
2030	"	"	"	"	"			1H.3.6.8.13.24.39a	
3033	"	"	"	"	"			1H.3.6.8.13.24.40	
3034	"	"	"	12,0	"			1H.3.6.8.13.24.40	Kond.rom utvidet til 1800 mm
3035	"	"	"	"	"			1H.3.6.8.13.24	
3036	"	"	"	12,5	"			1H.3.6.8.13.24	
3037	"	"	"	13,0	"			1H.3.5.8.13.24.39a	Går i lasarettog. Dampradiator og elektr. ovn i reisegodsrom.
3038	"	"	"	"	"			1H.3.6.8.13.24	
3039	"	"	"	12,5	"			1H.3.6.8.13.24	
5020	H	"	"	15,5	"			1H.3.6.8.13.24	Oppr. hovedt. 2531
6017	0	"	"	12,0	3,0			1H.3.6.8.13.24.40	
6018	"	"	"	12,5	"			1H.3.6.8.13.24.40	
6019	"	"	"	12,0	"			1H.3.6.8.13.24.39a	
6020	"	"	"	"	6,0			1H.3.6.8.13.24.40	
6021	"	"	"	"	"			1H.3.6.8.13.24.40	
6022	"	"	"	"	"			1H.3.6.8.13.24	Kond.rom utvidet til 1800 mm

Vogn nr.	Distriktsmerke	Fabrikant	Byggeår	Omtr. vognvekt i tonn	Reisegods, last i tonn	Grunnriss	El.varme i kW	Vognutstyr (se side 6)	Merknad
15017	D	Skb	19	14,0	3,0			1H.3.6.8.13.24	
17953	T	"	"	11,0	"			1H.3.6.8.13.24	1)
17954	"	"	"	"	"			1H.3.6.8.13.24	1)
17955	"	"	"	"	"			1H.3.5 ²).8.13.24	1)
20051	K	"	14	"	"			1H.3.6.8.13.24	
20052	D	"	"	"	"			1H.3.6.8.13.24	
20053	"	"	"	14,0	"			1H.3.6.8.13.24	
23101	"	"	15	14,5	"			1H.3.6.8.13.24	
23102	"	"	"	11,5	"			1H.3.6.8.10.24	3)

- 1) Hovedt. 1930
 2) Bare i godsrom
 3) Kond.rom etter tegn. 6061
 Trykk nr. 751 1.7.58

F

TYPE 11

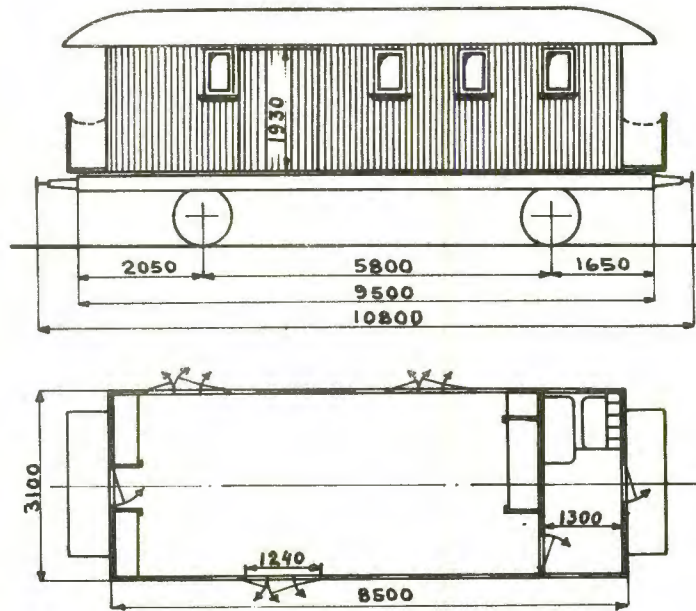

Hovedt. 2531
2558

Vogn nr.	Distriktsmerke	Fabrikant	Byggeår	Omtr. vognvekt i tonn	Reisegods, last i tonn	Grunnriss	El. varme i kW	Vognutstyr (se side 6)	Merknad
2025	0	Str	22	12,5	6,0			1H.3.6.8.13.24	
2026	"	"	"	"	"			1H.3.6.8.13.24	1)
2027	"	"	"	12,0	"			1H.3.6.8.13.24	1)
2028	"	"	"	12,5	"			1H.3.6.8.13.24	
2030	"	"	"	"	"			1H.3.6.8.13.24.39a	
3033	"	"	"	"	"			1H.3.6.8.13.24.40	
3034	"	"	"	12,0	"			1H.3.6.8.13.24.40	1)
3035	"	"	"	"	"			1H.3.6.8.13.24	
3036	"	"	"	12,5	"			1H.3.6.8.13.24	
3037	"	"	"	13,0	"			1H.3.5.8.13.24.39a	2)
3038	"	"	"	"	"			1H.3.6.8.13.24	
3039	"	"	"	12,5	"			1H.3.6.8.13.24	
5020	H	"	"	15,5	"			1H.3.6.8.13.24	3)

1) Kond.rom utvidet til 1800 mm.

2) Går i lasarettog. Dampradiator og elektr. ovn i reisegodsrom. Kond.rom utvidet til 1800 mm etter Od.M. skisse 703.

3) Oppr. hovedt. 2531.

F

TYPE 11

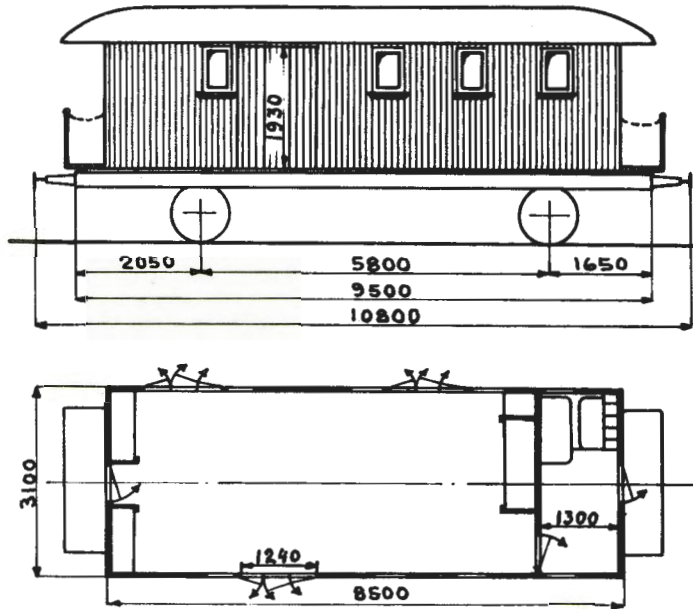

Hovedt. 2531
2558

Vogn nr:	Distriktsmerke	Fabrikant	Byggeår	Omr. vognvekt i tonn	Reisegods, last i tonn	Grunnriss	El. varme i kW	Vognutstyr (se side 6)	Merknad
2025	0	Str	22	12,5	6,0			1H.3.6.8.13.24	
2026	"	"	"	"	"			1H.3.6.8.13.24	1)
2027	"	"	"	12,0	"			1H.3.6.8.13.24	1)
2028	"	"	"	12,5	"			1H.3.6.8.13.24	
2030	"	"	"	"	"			1H.3.6.8.13.24.39a	
3033	"	"	"	"	"			1H.3.6.8.13.24.40	
3034	"	"	"	12,0	"			1H.3.6.8.13.24.40	1)
3035	"	"	"	"	"			1H.3.6.8.13.24	
3036	"	"	"	12,5	"			1H.3.6.8.13.24	
3037	"	"	"	13,0	"			1H.3.5.8.13.24.39a	2)
3038	"	"	"	"	"			1H.3.6.8.13.24	
3039	"	"	"	12,5	"			1H.3.6.8.13.24	
5020	H	"	"	15,5	"			1H.3.6.8.13.24	3)

1) Kond.rom utvidet til 1800 mm.

2) Går i lasarettog. Dampradiator og elektr. ovn i reisegodsrom. Kond.rom utvidet til 1800 mm etter Od.M. skisse 703.

3) Oppr. hovedt. 2531.

Vogn nr.	Distriktsmerke	Fabrikant	Byggeår	Omtr. vognvekt i tonn	Reisegods, last i tonn	Grunnriss	El.varme i kW	Vognutstyr (se side 6)	Merknad
15017	D	Skb	19	14,0	3,0			1H.3.6.8.13.24	
17953	T	"	"	11,0	"			1H.3.6.8.13.24	1)
17954	"	"	"	"	"			1H.3.6.8.13.24	1)
17955	"	"	"	"	"			1H.3.5 ²).8.13.24	1)
20051	K	"	14	"	"			1H.3.6.8.13.24	
20052	D	"	"	"	"			1H.3.6.8.13.24	
20053	"	"	"	14,0	"			1H.3.6.8.13.24	
23101	"	"	15	14,5	"			1H.3.6.8.13.24	
23102	"	"	"	14,0	"			1H.3.6.8.13.24	

1) Hovedt. 1930

2) Bare i godsrom

Vogn nr.	Distriktsmerke	Fabrikant	Byggeår	Omtr. vognvekt i tonn	Reisegods, last i tonn	Grunnriss	El. varme i kW	Vognutstyr (se side 6)	Merknad
5021	H	Str	24		6,0			1H.3.6.8.13.24	3)
5022	"	"	"		"			1H.3.6.8.13.24	3)
5023	"	"	"	12,0	"			1H.3.6.8.13.24	
5024	"	"	"	"	"			1H.3.6.8.13.24	
6017	O	"	22	"	3,0			1H.3.6.8.13.24.40	
6018	"	"	"	12,5	"			1H.3.6.8.13.24.40	
6019	"	"	"	12,0	"			1H.3.6.8.13.24.39a	
6020	"	"	"	"	6,0			1H.3.6.8.13.24.40	
6021	"	"	"	"	"			1H.3.6.8.13.24.40	
6022	"	"	"	"	"			1H.3.6.8.13.24	1)
17451	"	"	"	"	"			1H.3.6.8.13.24	3)
20054	D	"	"	12,5	"			1H.3.6.8.13.24.40	4)
20055	"	"	"	"	"			1H.3.6.8.13.24.40	
20056	"	"	"	15,0	"			1H.3.6.8.13.24.40	
20057	"	"	"	12,0	"			1H.3.6.8.13.24.40	4)
20773	"	"	"	"	"			1H.3.6.8.13.24	3)
20774	K	"	"	"	"			1H.3.6.8.13.24	3)

1) Kond.rom utvidet til 1800 mm.

3) Oppr. hovedt. 2531.

4) Kond.rom etter tegn. 6061.

F

TYPE 12

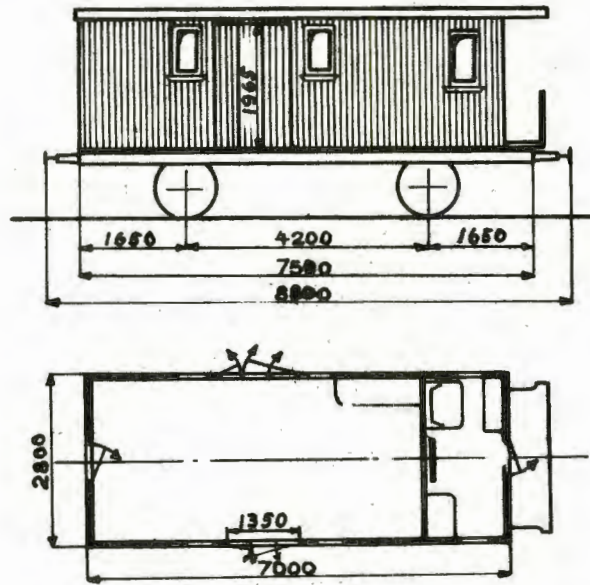

Hovedt. 5389

Vogn nr.	Distriktsmerke	Fabrikant	Byggeår	Omr. vognvekt i tonn	Reisegods, last i tonn	Grunnriss	El.varme i kW	Vognutstyr (se side 6)	Merknad
6023	0	Skb	02		4,0			3.6.8.13.15.24	
6024	"	"	"	8,5	"			3.6.8.13.15.24	

Trykk nr. 751 1.7.56

Vogn nr.	Distriktsmerke	Fabrikant	Byggeår	Omtr. vognvekt i tonn	Reisegods, last i tonn	Grunnriss	El.varme i kW	Vognutstyr (se side 6)	Merknad
5021	H	Str	24		6,0			1H.3.6.8.13.24	3)
5022	"	"	"		"			1H.3.6.8.13.24	3)
5023	"	"	"	12,0	"			1H.3.6.8.13.24	
5024	"	"	"	"	"			1H.3.6.8.13.24	
6017	O	"	22	"	3,0			1H.3.6.8.13.24.40	
6018	"	"	"	12,5	"			1H.3.6.8.13.24.40	
6019	"	"	"	12,0	"			1H.3.6.8.13.24.39a	
6020	"	"	"	"	6,0			1H.3.6.8.13.24.40	
6021	"	"	"	"	"			1H.3.6.8.13.24.40	
6022	"	"	"	"	"			1H.3.6.8.13.24	1)
17451	"	"	"		"			1H.3.6.8.13.24	3)
20054	D	"	"	12,5	"			1H.3.6.8.13.24.40	4)
20055	"	"	"	"	"			1H.3.6.8.13.24.40	
20056	"	"	"	13,0	"			1H.3.6.8.11.24.40	4)
20057	"	"	"	12,0	"			1H.3.6.8.13.24.40	4)
20773	"	"	"		"			1H.3.6.8.13.24	3)
20774	K	"	"		"			1H.3.6.8.13.24	3)

1) Kond.rom utvidet til 1800 mm.

3) Oppr. hovedt. 2531.

4) Kond.rom etter tegn. 6061.

F

TYPE 12

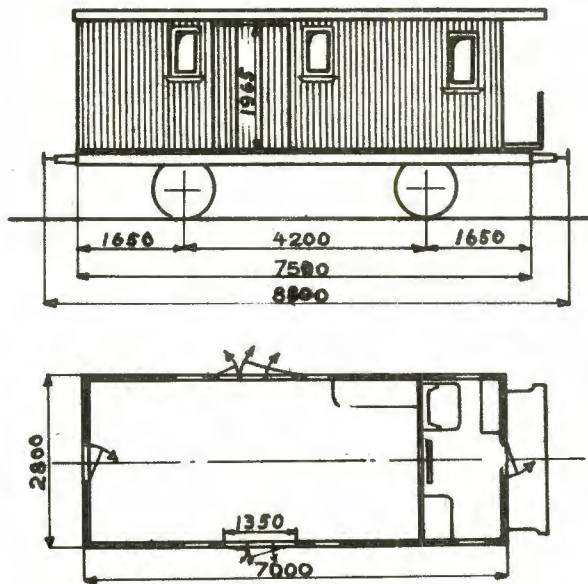

Hovedt. 5389

Vogn nr.	Distriktsmerke	Fabrikant	Byggeår	Omr. vognvekt i tonn	Reisegods, last i tonn	Grunnriss	El.varme i kW	Vognutstyr (se side 6)	Merknad
6023	0	Skb	02		4,0			3.6.8.13.15.24	
6024	=	"	"	8,5	"			3.6.8.13.15.24	

Trykk nr. 751 1.7.56

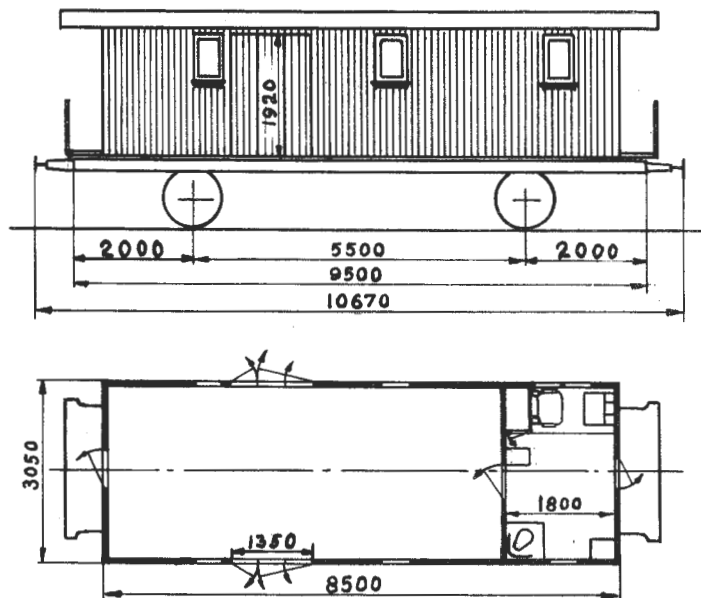

Oppr. hovedt. 662

Vogn nr.	Distriktsmerke	Fabrikant	Byggeår	Omr. vognvekt i tonn	Reisegods, last i tonn	Grunnriss	El. varme i kW	Vognutstyr (se side 6)	Merknad
13022	0	Skb	02	11,0				3.6.8.13.15.24	

F

TYPE 14

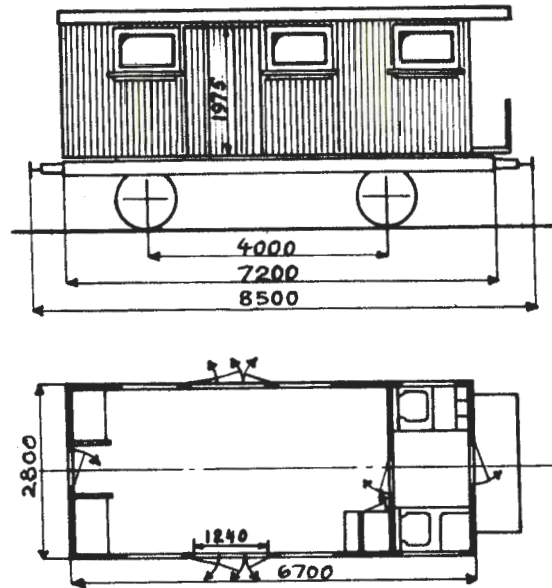

Oppr. hovedt. Oslo d. 882¹⁾

Vogn nr.	Distriktsmerke	Fabrikant	Byggeår	Omtr. vognvekt i tonn	Reisegods, last i tonn	Grunnriss	El.varme i kW	Vognutstyr (se side 6)	Merknad
2014	0	AaB	10		5,0			1H.3.6.8.13.24	

1) Ny vognkasse etter tegn. 5240
Trykk nr. 751 1.7.56

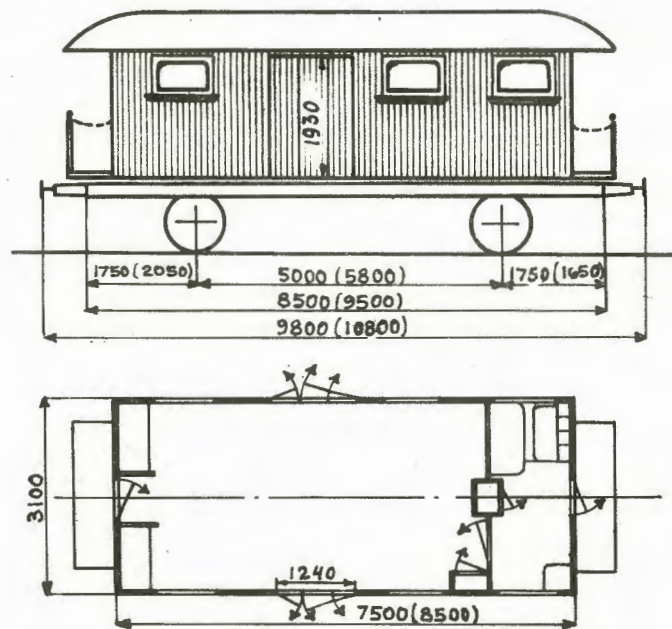

Oppr. hovedt. 2104¹⁾
2558¹⁾

Vogn nr.	Distriktsmerke	Fabrikant	Byggeår	Omtr. vognvekt i tonn	Reisegods, last i tonn	Grunnriss	El.varme i kW	Vognutstyr (se side 6)	Merknad
2023	0	Str	13	10,5	5,0			1H.3.6.8.13.24	
5010	H	"	14	"	3,0			1H.3.6.8.13.24	
2029	0	"	22	12,0	6,0			1H.3.6.8.13.24.39a	Oppr. hovedt. 2558

Mål i () gjelder vogn 2029
1) Ny vognkasse etter tegn 5172
Trykk nr. 751 1.7.56

F

TYPE 16

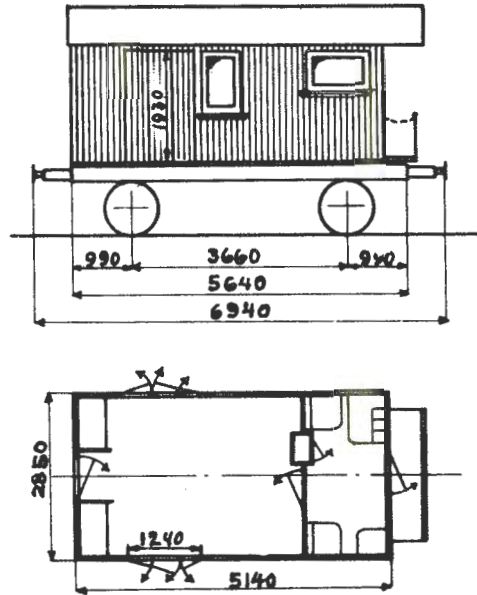

Oppr. hovedt. 118¹⁾
853¹⁾

Vogn nr:	Distriktsmerke	Fabrikant	Byggeår	Omr. vognvekt i tonn	Reisegods, last i tonn	Grunnriss	El. varme i kW	Vognutstyr (se side 6)	Merknad
14952	B	Edf	06	9,0	4,0			1H.3.6.8.13	Oppr. hovedt. 118
8487	"	Str	07	"	"			1H.3.6.8.13	

1) Ny vognkasse etter tegn. 5156
Trykk nr. 751 1.7.56

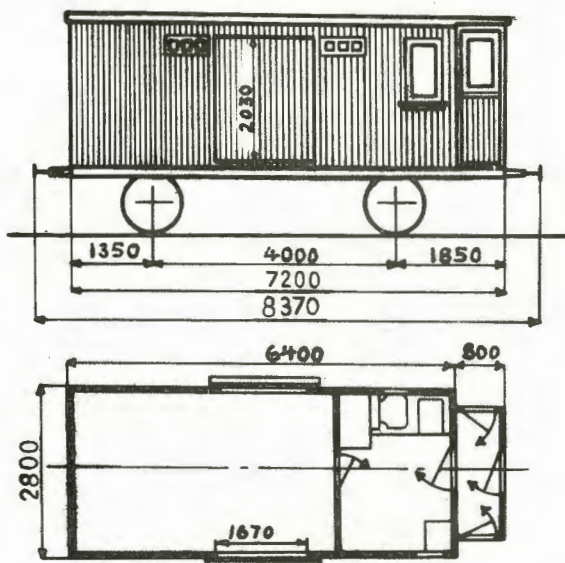

Oppr. hovedt. 376
387

Vogn nr.	Distriktsmerke	Fabrikant	Byggeår	Omtr. vognvekt i tonn	Reisegods, last i tonn	Grunnriss	El.varme i kW	Vognutstyr (se side 6)	Merknad
6284	0	Edf	09					3.5.8.13.15	

Fo

TYPE 1

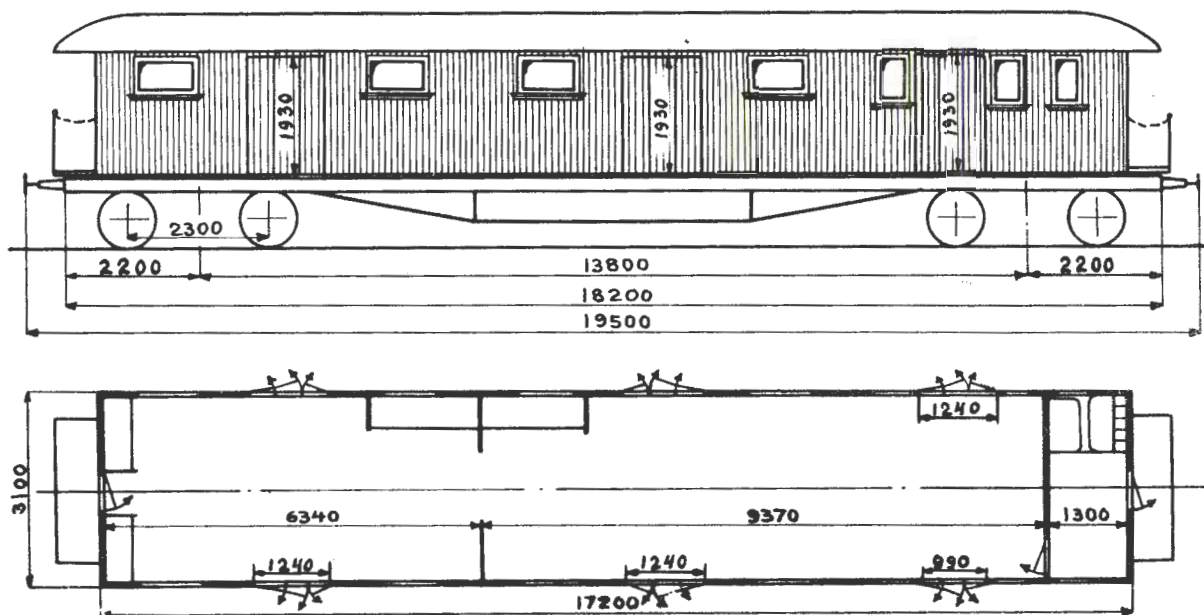

Hovedt. 2464

Vogn nr.	Distriktsmerke	Fabrikant	Byggeår	Omr. vognvekt i tonn	Reisegods, last i tonn	Grunnriss	El.varme i kW	Vognutstyr (se side 6)	Merknad
5679	T	Str	22	28,5	12,0			1H.3.5.8.10.39a	

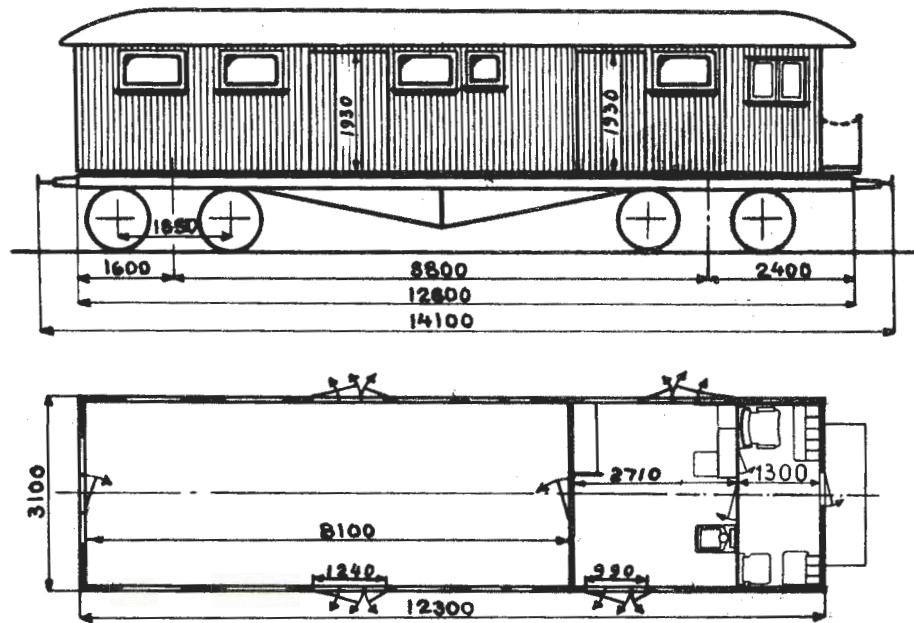

Hovedt. 2554

Vogn nr.	Distriktsmerke	Fabrikant	Byggeår	Omtr. vognvekt i tonn	Reisegods, last i tonn	Grunnriss	El.varme i kW	Vognutstyr (se side 6)	Merknad
20062	D	Str	22	20,0	8,0			1H.3.6.8.10.40	} Sykkelopphengning i reisegodsrom
20063	"	"	"	19,0	"			1H.3.6.8.10.40	

Fo

TYPE 3

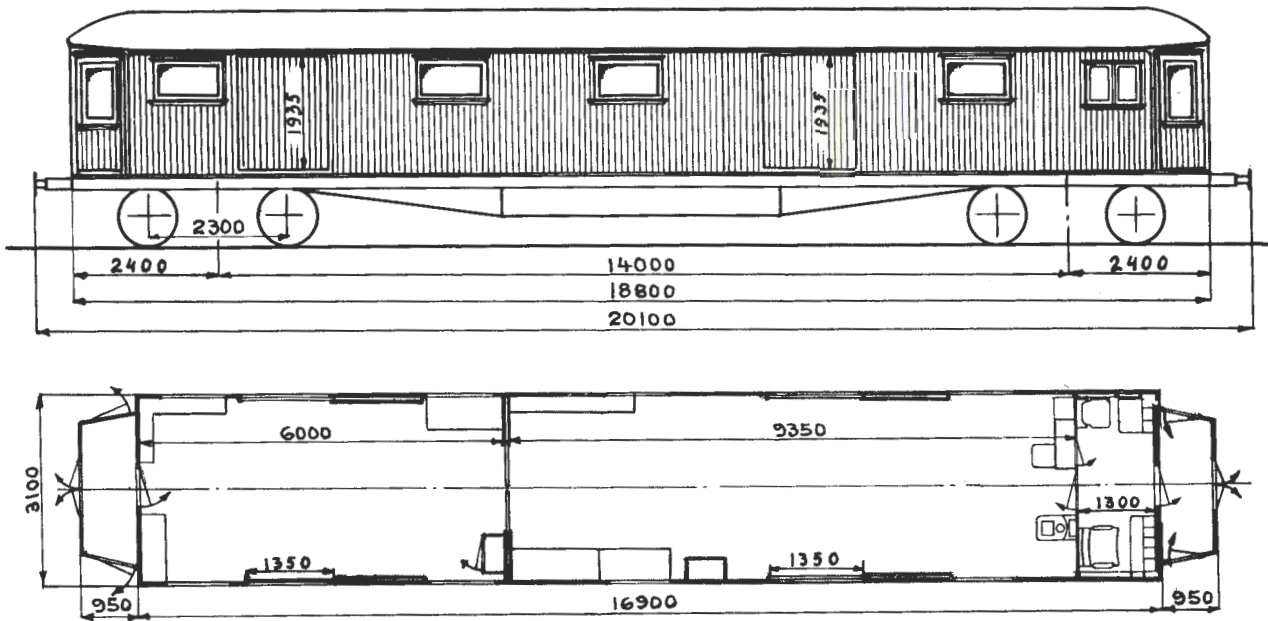

Hovedt. 4372

Vogn nr.	Distriktsmerke	Fabrikant	Byggeår	Omtr. vognvekt i tonn	Reisegods, fast i tonn	Grunnriss	Elvarme i kW	Vognutstyr (se side 6)	Merknad
14013	B	Skb	38	29,5	12,0			1H.3.5.8.11.28.39a	
14014	"	"	"	28,0	"			1H.3.5.8.11.28 ¹⁾ .39a	
14015	"	"	"	28,5	"			1H.3.5.8.11.28.39a	} Plattform sidedører slår ut } 3-delte hengslede dører etter tegn. 4967
20064	D	Str	"	"	"			1H.3.5.8.11.28 ¹⁾ .39a	
20065	"	"	"	"	"			1H.3.5.8.11.28 ¹⁾ .39a	
20066	"	"	"	28,0	"			1H.3.5.8.11.28.39a	

1) Bare i ende ved konduktørrom
Trykk nr. 751 1.7.56

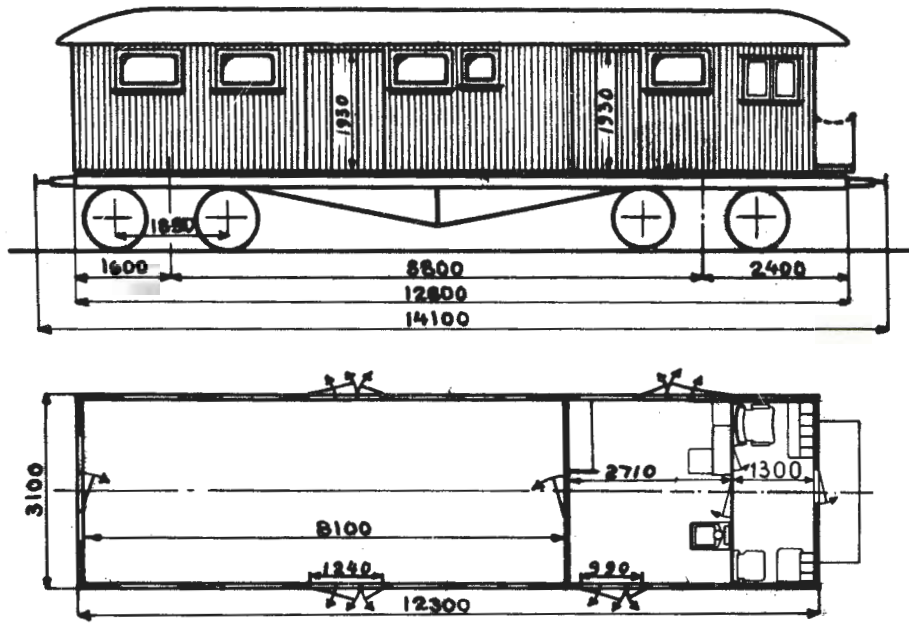

Hovedt. 2554

Vogn nr.	Distriktsmerke	Fabrikant	Byggeår	Omr. vognvekt i tonn	Reisegods, last i tonn	Grunnriss	El.varme i kW	Vognutstyr (se side 6)	Merknad
20062	D	Str	22	20,0	8,0			1H.3.6.8.10.40	} Sykkelopphengning i reisegodsrom Sagget
20063	=	=	=	19,0	"			1H.3.6.8.10.40	

Fo

TYPE 3

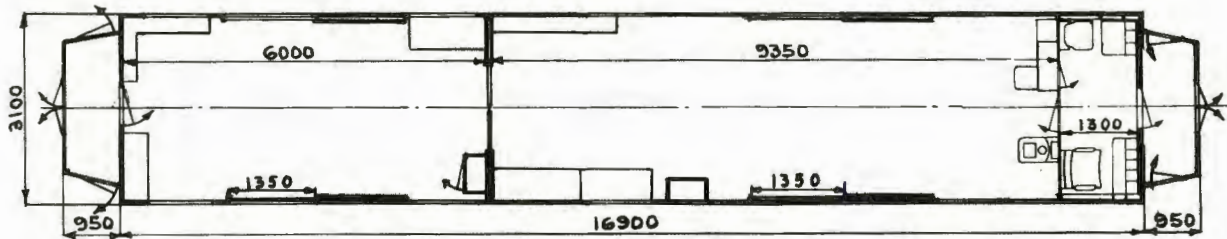
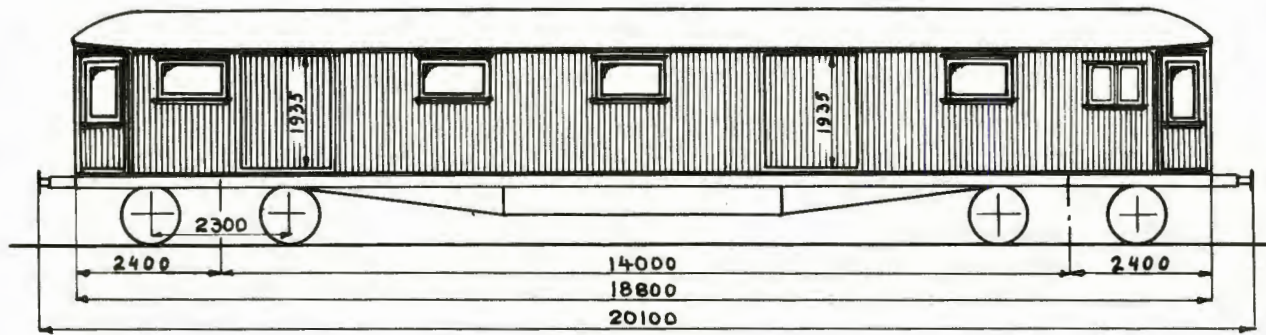

Hovedt. 4372

Vogn nr.	Distriktsmerke	Fabrikant	Byggeår	Omr. vognvekt i tonn	Reisegods, last i tonn	Grunnriss	El-varme i kW	Vognutstyr (se side 6)	Merknad
14013	0	Skb	38	29,5	12,0			1H.3.5.8.11.28.39a	
14014	"	"	"	28,0	"			1H.3.5.8.11.28 ¹).39a	
14015	B	"	"	28,5	"			1H.3.5.8.11.28.39a	2)
20064	D	Str	"	"	"			1H.3.5.8.11.28 ¹).39a	2)
20065	"	"	"	"	"			1H.3.5.8.11.28 ¹).39a	4)
20066	"	"	"	28,0	"			1H.3.5.8.11.28.39a	3)4)

- 1) Bare i ende ved konduktörrom
- 2) Plattform sidedører slår ut
- 3) " " " inn
- 4) 3-delte hengslede dører etter tegn. 4967

Trykk nr. 751 1.7.57

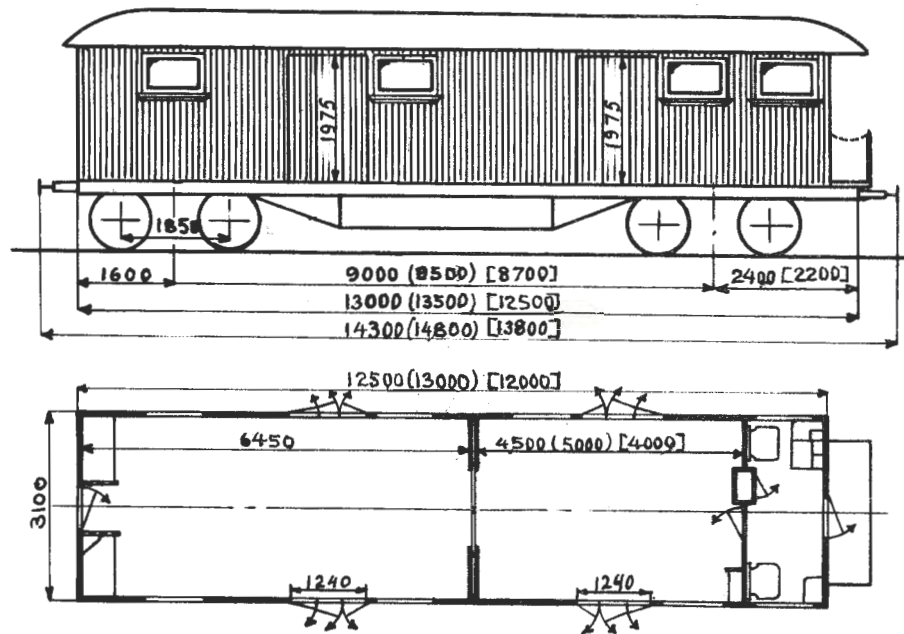

Oppr. hovedt. 770¹⁾
2633¹⁾
2898¹⁾

Vogn nr.	Distriktsmerke	Fabrikant	Byggeår	Omtr. vognvekt i tonn	Reisegods, last i tonn	Grunnriss	El.varme i kW	Vognutstyr (se side 6)	Merknad
15019	D	Str	18	18,0	13,0			1H.3.6.8.10.39a	Oppr. hovedt. 770
3044	0	Skb	23	18,5	"			1H.3.6.8.10.40	} Oppr. hovedt. 2633
3047	"	"	"	"	"			1H.3.6.8.10.39a	
3046	"	Str	25	19,0	"			1H.3.6.8.10.40	} Oppr. hovedt. 2898
3045	"	"	26	18,5	"			1H.3.6.8.10.40	

Mål i () gjelder vogner etter hovedt. 2998

Mål i [] gjelder vogner etter hovedt. 2633

1) Ny vognkasse etter tegn. 5170
Trykk nr. 751 1.7.56

Fo

TYPE 5

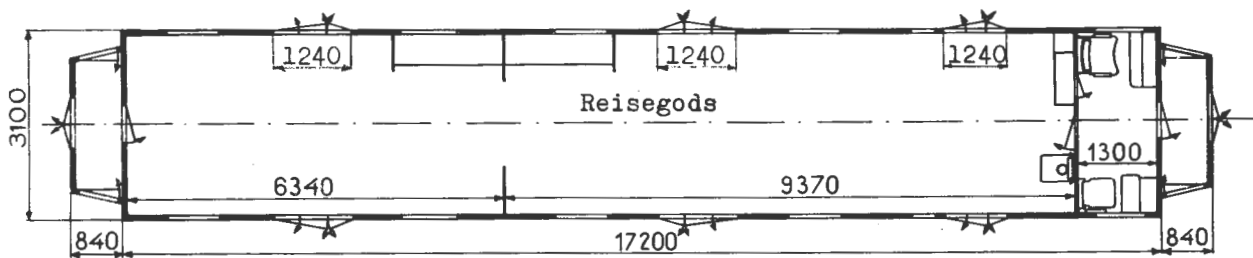
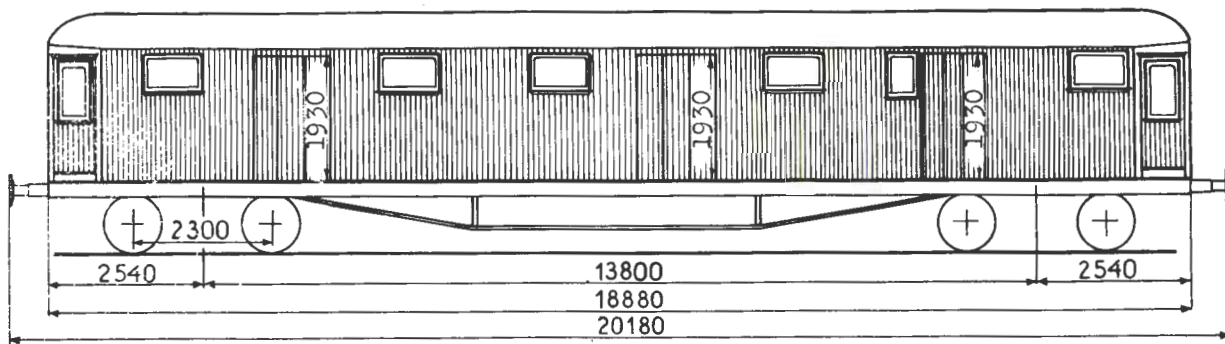

Oppr. hovedt. 2463
2464

Vogn nr.	Distriktsmerke	Fabrikant	Byggeår	Omr. vognvekt i tonn	Reisegods, last i tonn	Grunnriss	El. varme i kW	Vognutstyr (se side 6)	Merknad
5678	T	Str	22	28,5	12,0			1H.3.5.8.11.28 ¹⁾ .39a	Kjölerom
5680	"	"	"	29,0	"			1H.3.5.8.11.28.40	
5681	"	"	"	28,5	"			1H.3.5.8.11.28.40	
19956	"	"	"	27,0	"			1H.3.6.8.11.28.40	

1) Bare i ende ved kond.rom
Trykk nr. 751 1.7.56

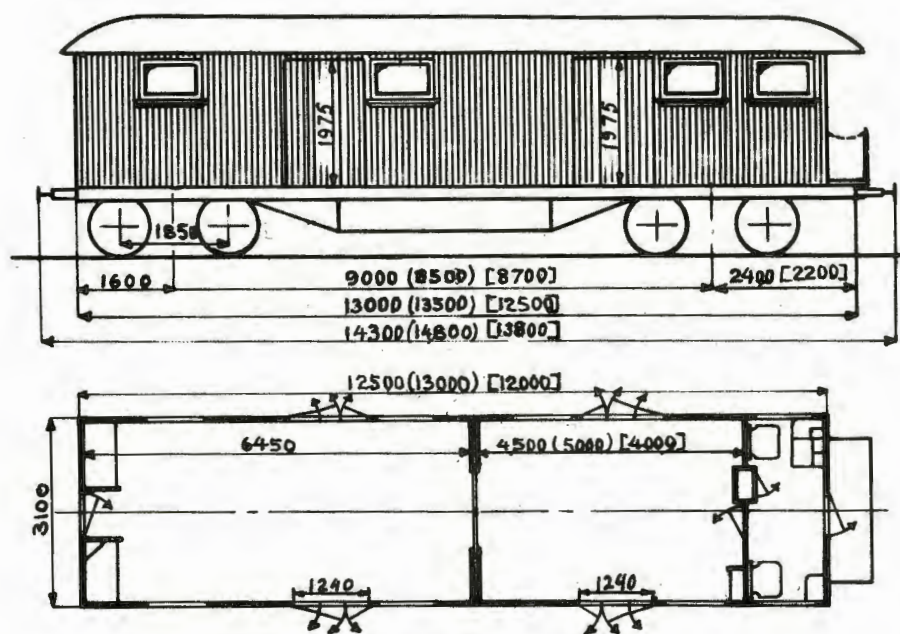

Oppr. hovedt. $\left. \begin{matrix} 770 \\ 2633 \\ 2898 \end{matrix} \right\}^1$

Vogn nr.	Distriktsmerke	Fabrikant	Byggeår	Omtr. vognvekt i tonn	Reisegods, last i tonn	Grunnriss	El. varme i kW	Vognutstyr (se side 6)	Merknad
15019	D	Str	18	18,0	13,0			1H.3.6.8.10.39a	Oppr. hovedt. 770
3044	O	Skb	23	18,5	"			1H.3.6.8.10.40	Oppr. hovedt. 2633
3047	"	"	"	"	"			1H.3.6.8.10.39a	
3046	"	Str	25	19,0	"			1H.3.6.8.10.40	Oppr. hovedt. 2898
3045	"	"	26	18,5	"			1H.3.6.8.10.40	

Mål i () gjelder vogner etter hovedt. 2998

Mål i [] gjelder vogner etter hovedt. 2633

Fo
TYPE 5

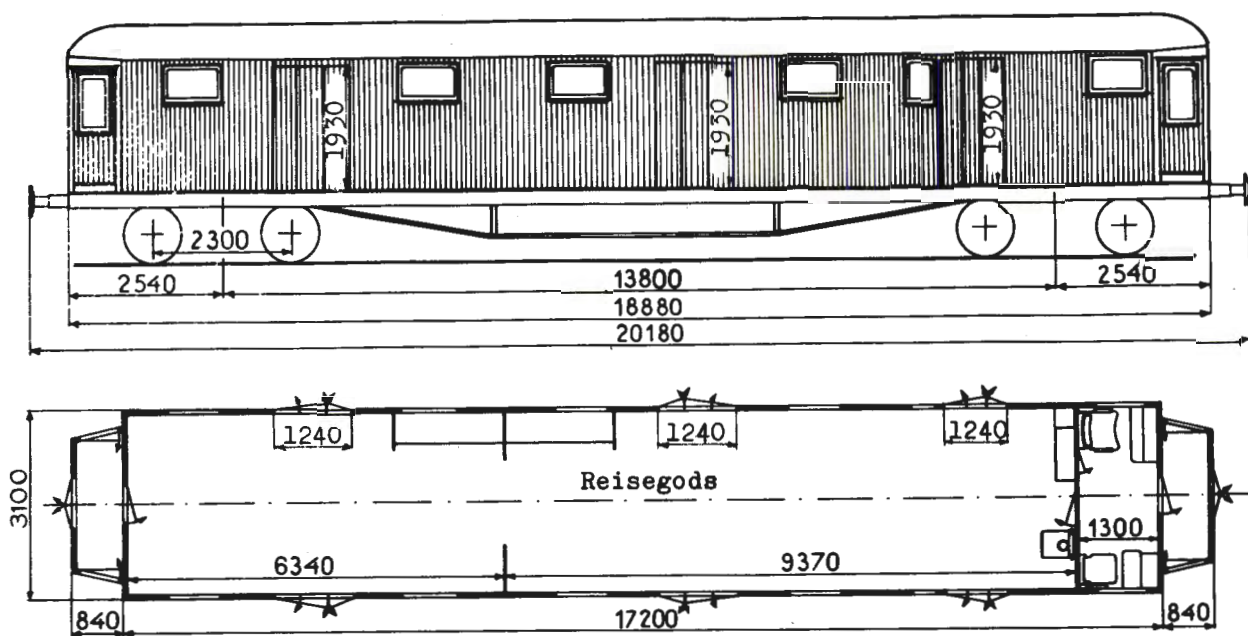

Oppr. hovedt. 2463
2464

Vogn nr	Distriktsmerke	Fabrikant	Byggeår	Omtr. vognvekt i tonn	Reisegods, last i tonn	Grunnriss	El.varme i kW	Vognutstyr (se side 6)	Merknad
5678	†	Str	22	28,5	12,0			1H.3.5.8.11.28 ¹⁾ .39a	

1) Bare i ende ved kond.rom
Trykk nr. 751 1.7.57

Fo
 TYPE 6
 Stålvogner

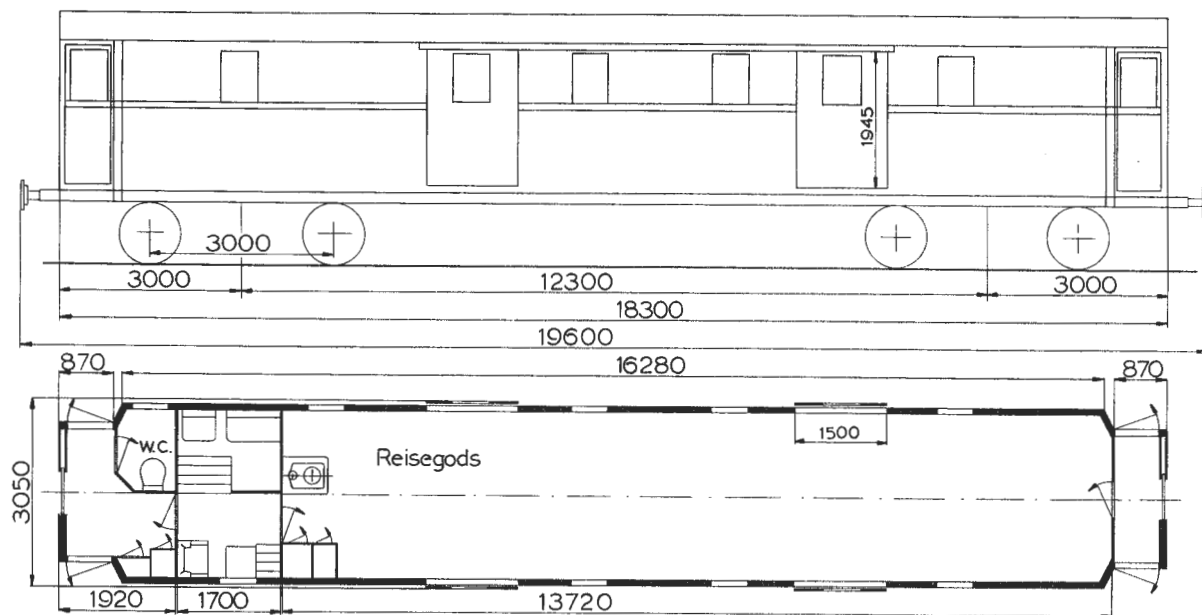

Hovedt.skisse 915

Vogn nr.	Distriktsmerke	Fabrikant	Byggeår	Omtr. vognvekt i tonn	Reisegods, last i tonn	Grunnriss	El. varme i kW	Vognutstyr (se side 6)	Merknad
19951	O		31	31,5	10,0			1kk. 3. 5. 8. 11. 28.39a.	
19952	O		32	30,5	10,0			1kk. 3. 6. 8. 11. 28.39a.	

Fo

TYPE 7

Stålvogner

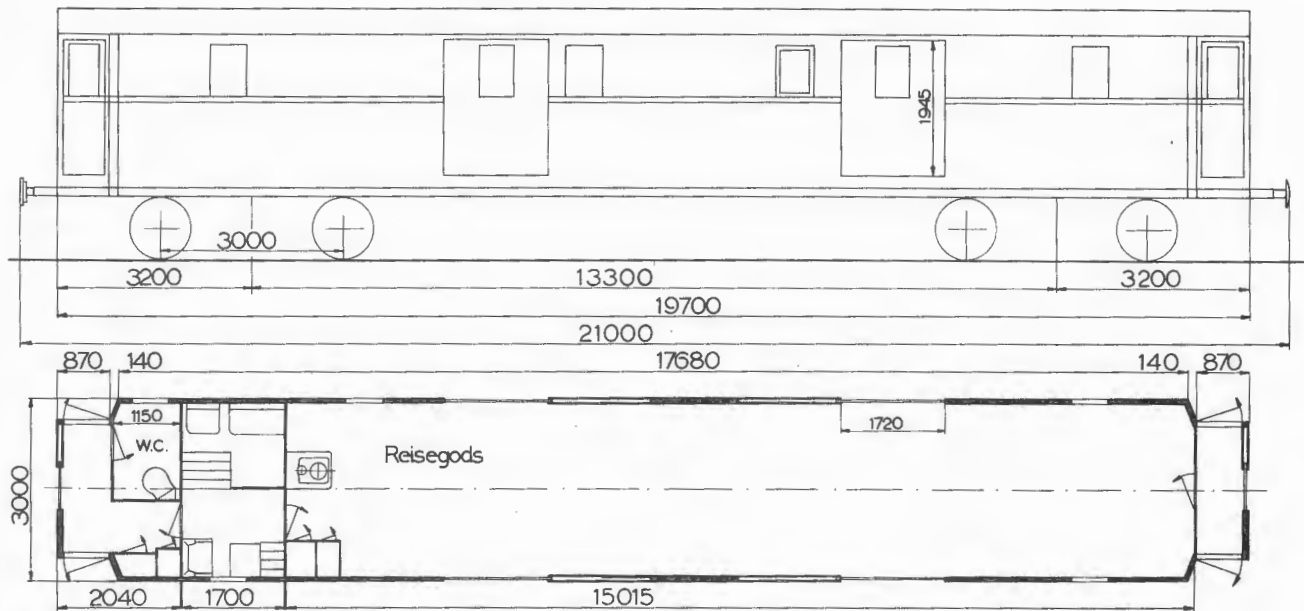

Hovedt. skisse 916

Vogn nr:	Distriktsmerke	Fabrikant	Byggeår	Omtr. vognvekt i tonn	Reisegods, last i tonn	Grunnriss	El. varme i kW	Vognutstyr (se side 6)	Merknad
19953	0		33	30,5	10,0			1kk. 3. 6. 8. 11. 28. 39a.	

Fo
TYPE 6
Stålvogner

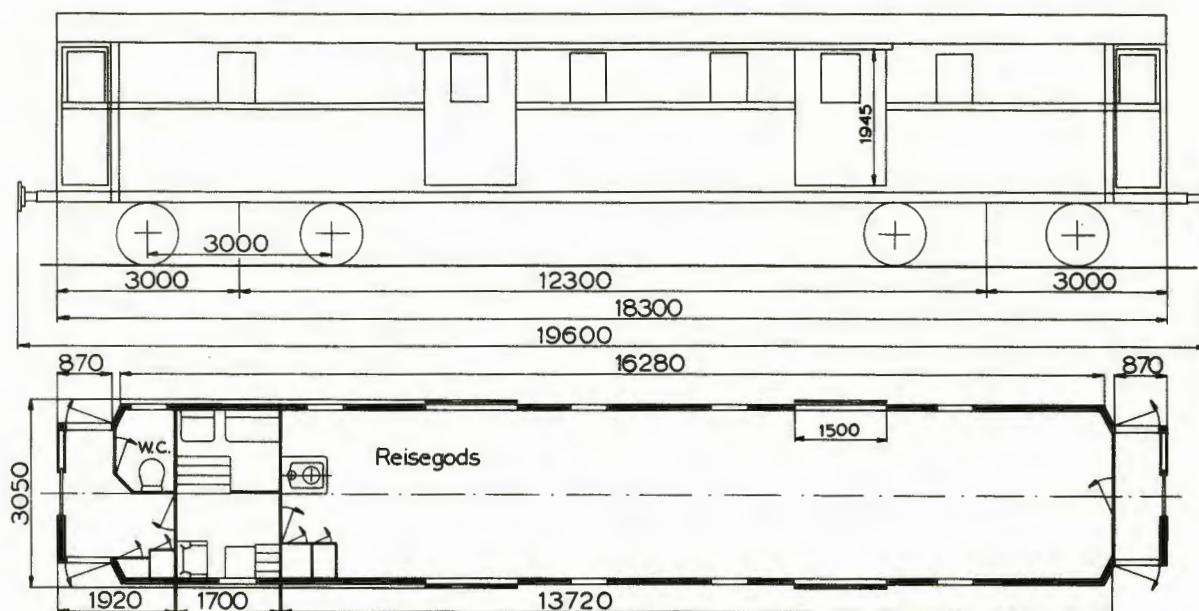

Hovedt.skisse 915

Vogn nr.	Distriktsmerke	Fabrikant	Byggeår	Omtr. vognvekt i tonn	Reisegods, last i tonn	Grunnriss	El. varme i kW	Vognutstyr (se side 6)	Merknad
19951	O		31	31,5	10,0			1kk. 3. 5. 8. 11. 28.39a	1)
19952	O		32	30,5	10,0			1kk. 3. 6. 8. 11. 28.39a	

1) 4-delte dører i reisegodsrom

Fo

TYPE 7

Stålvogner

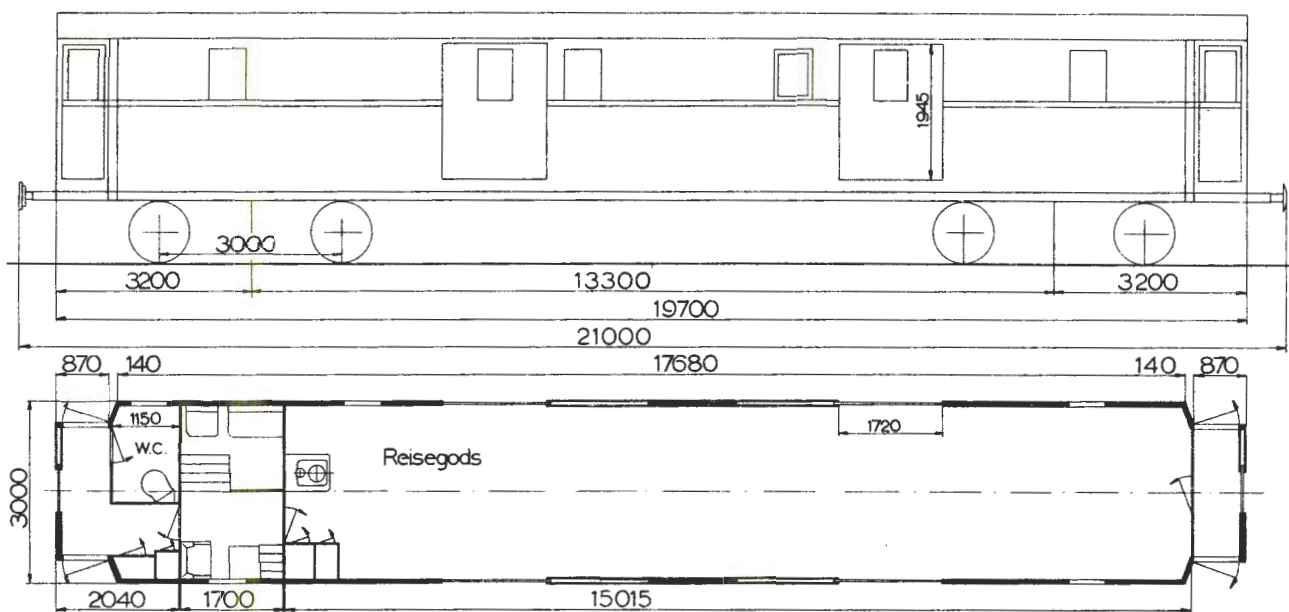

Hovedt. skisse 916

Vogn nr.	Distriktsmerke	Fabrikant	Byggeår	Omr. vognvekt i tonn	Reisegods, last i tonn	Grunnriss	El. varme i kW	Vognutstyr (se side 6)	Merknad
19953	0		33	30,5	10,0			1kk.3. 6. 8. 11. 28. 39a.	

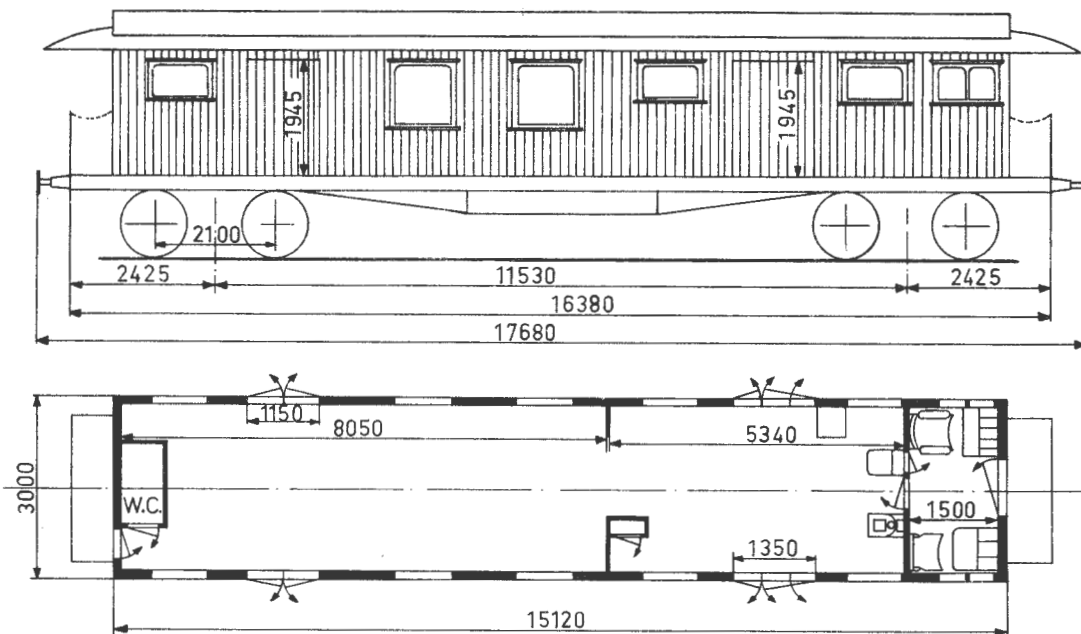

Hovedt. B. 497

Vogn nr.	Distriktsmerke	Fabrikant	Byggeår	Omr. vognvekt i tonn	Reisegods, last i tonn	Grunnriss	Elvarme i kW	Vognutstyr (se side 6)	Merknad
92	O	Skb	94	25,0	7,0			1H. 3.5. 8.11. 39a	

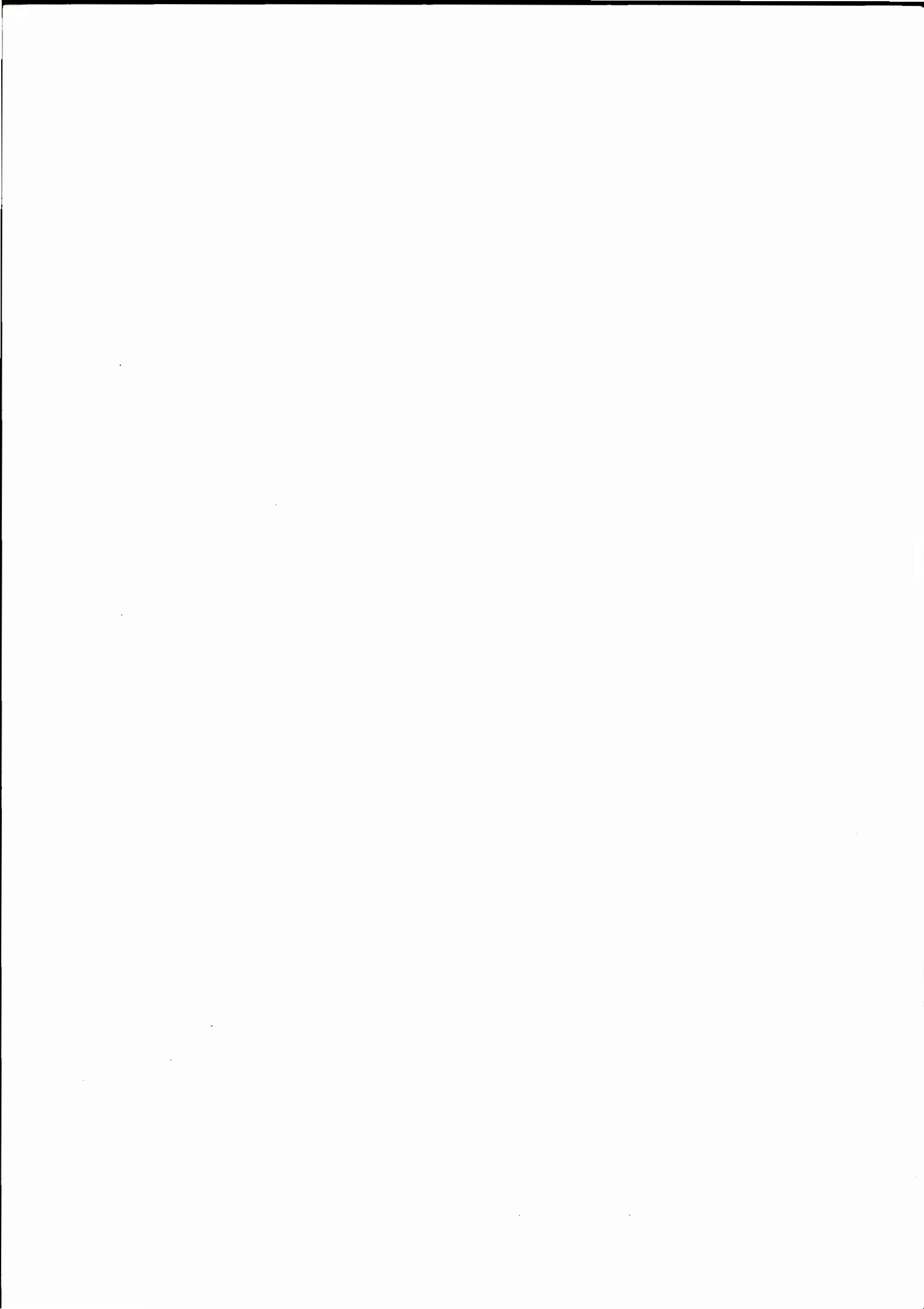

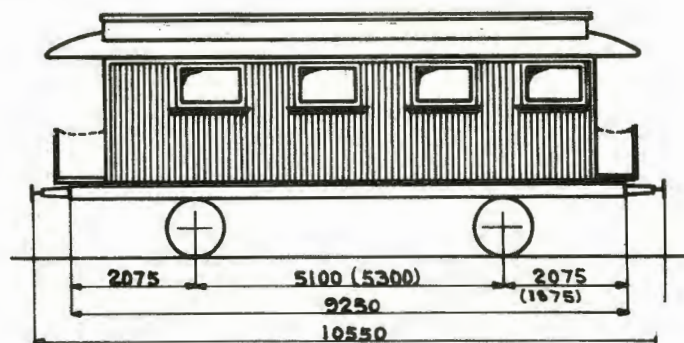

Grunnriss 1
Hovedt. B. 515

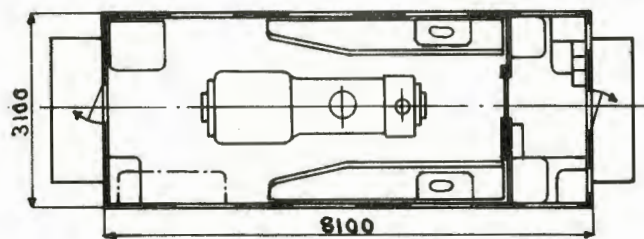

Grunnriss 2
Hovedt. 3043

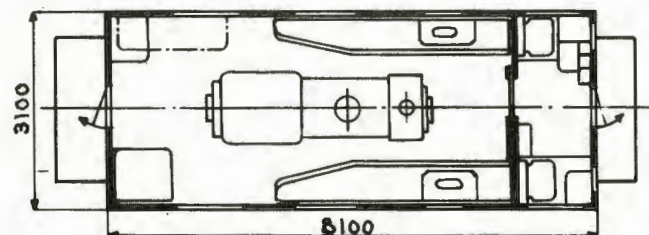

Vogn nr.	Distriktsmerke	Fabrikant	Byggeår	Omtr. vognvekt i tonn	Reisegods, last i tonn	Grunnriss	El. varme i kW	Vognutstyr (se side 6)	Merknad
1025	0	NHJ	23	19,0				1H.3.5.8.13.24	
1026	"	"	"	"				1H.3.5.8.13.24	
1027	"	"	"	18,5				1H.3.5.8.13.24	
3040	"	Skb	28	17,5				1H.3.6.8.13.24	
3041	"	"	"	18,0				1H.3.6.8.13.24	
3042	"	"	"	17,5				1H.3.6.8.13.24	
3043	"	"	"	18,0				1H.3.6.8.13.24	

Mål i () gjelder grunnriss 2
Trykk nr. 751 1.7.57

Fd

TYPE 2

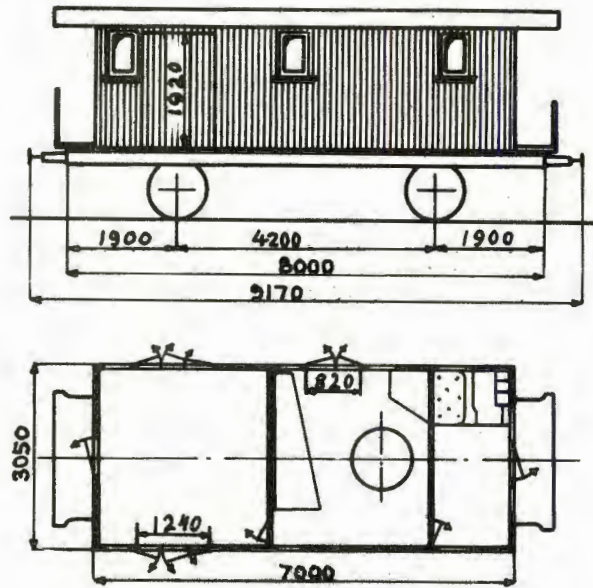

Hovedt. 478

Vogn nr.	Distriktsmerke	Fabrikant	Byggeår	Omr. vognvekt i tonn	Reisegods, last i tonn	Grunnriss	El.varme i kW	Vognutstyr (se side 6)	Merknad
14004	B	Str	07	11,5	1,0			1H.3.6.8.13.24	

Trykk nr. 751 1.7.57

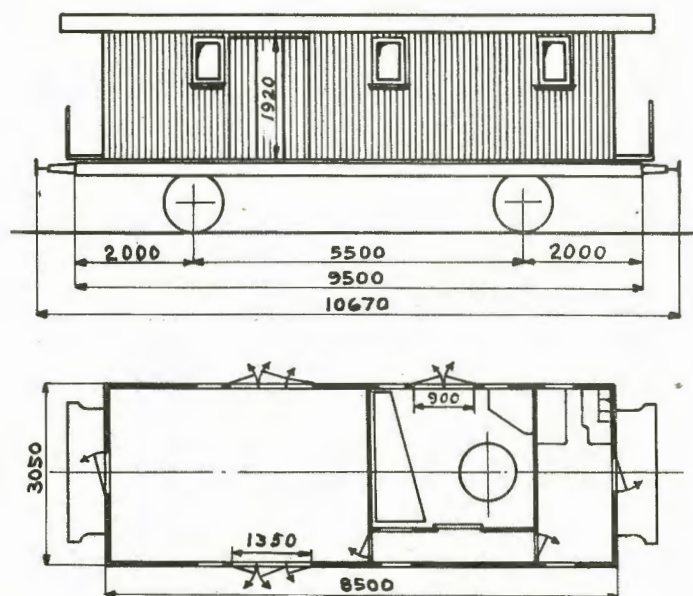

Hovedt. 662

Vogn nr	Distriktsmerke	Fabrikant	Byggeår	Omtr. vognvekt i tonn	Reisegods, last i tonn	Grunnriss	El. varme i kW	Vognutstyr (se side 6)	Merknad
13021	N	Skb	02	18,0	2,0			1W.3.6.13.24	

Fd

TYPE 4

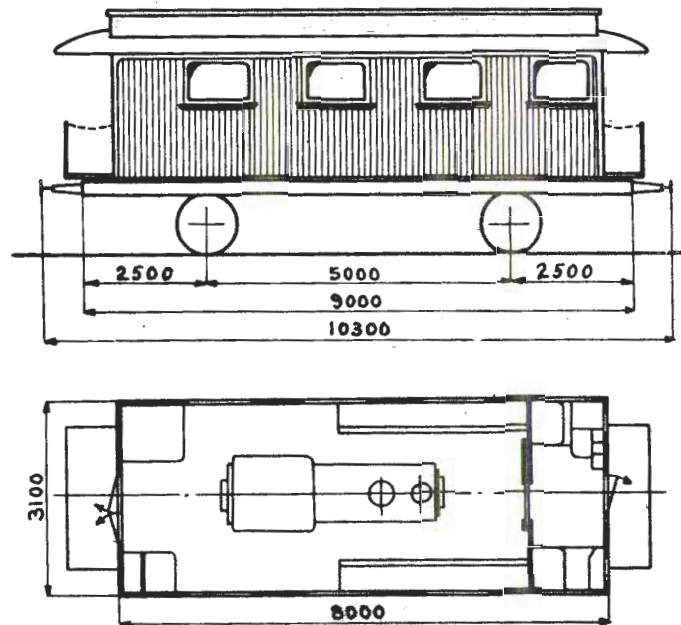

Hovedt. B. 482

Vogn nr.	Distriktsmerke	Fabrikant	Byggeår	Omtr. vognvekt i tonn	Reisegods, last i tonn	Grunnriss	El.varme i kW	Vognutstyr (se side 6)	Merknad
1023	0	NHJ	21	18,5				3.5.8.13.15.24	
1024	"	"	"	"				3.5.8.13.15.24	

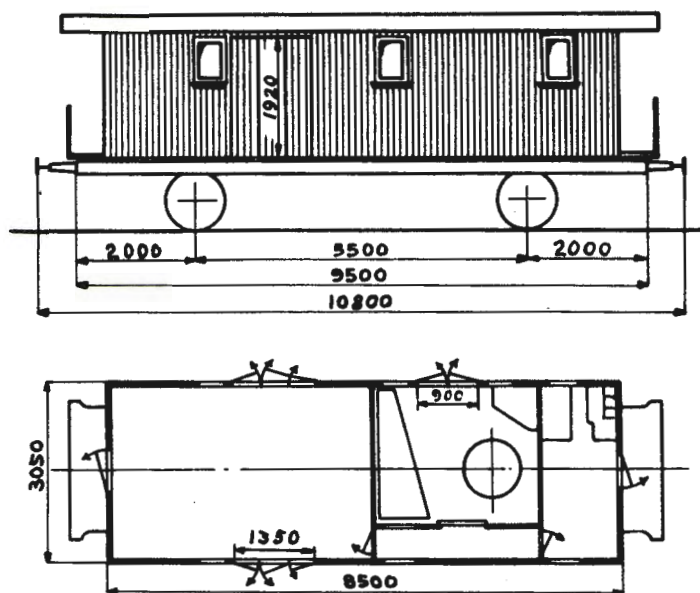

Hovedt. 662

Vogn nr.	Distriktsmerke	Fabrikant	Byggeår	Omr. vognvekt i tonn	Reisegods, last i tonn	Grunnriss	El. varme i kW	Vognutstyr (se side 6)	Merknad
13021	N	Skb	02	18,0	2,0			1W.3.6.13.24	

Fd

TYPE 4

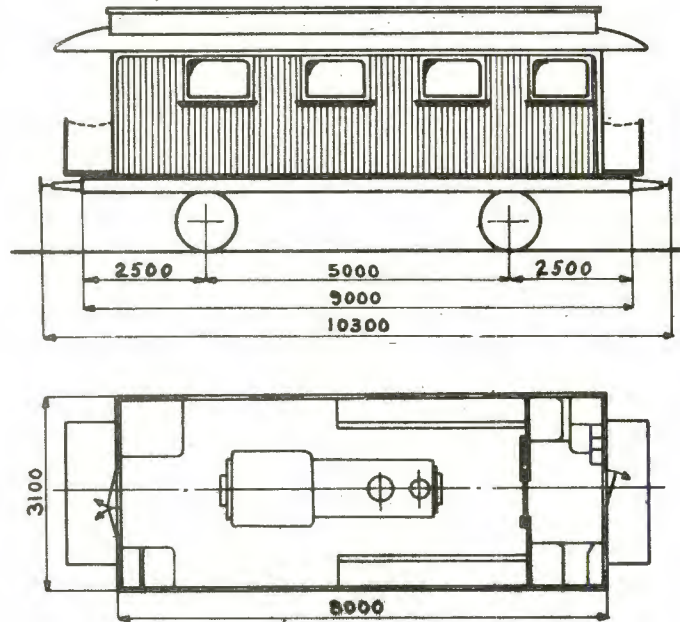

Hovedt. B. 482

Vogn nr.	Distriktsmerke	Fabrikant	Byggear	Omr. vognvekt i tonn	Reisegods, last i tonn	Grunnriss	El.varme i kW	Vognutstyr (se side 6)	Merknad
1023	0	NHJ	21	18,5				3.5.8.13.15.24	
1024	"	"	"	"				3.5.8.13.15.24	

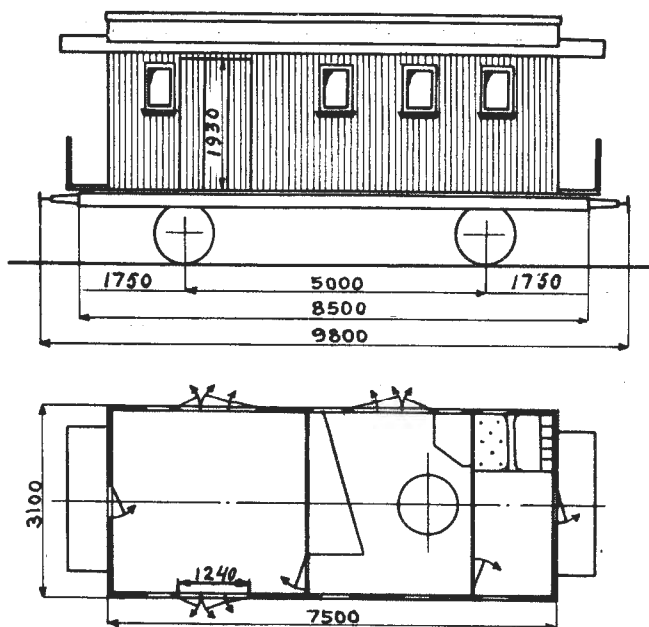

Hovedt. 2104

Vogn nr.	Distriktsmerke	Fabrikant	Byggeår	Omtr. vognvekt i tonn	Reisegods, last i tonn	Grunnriss	El. varme i kW	Vognutstyr (se side 6)	Merknad
17952	T	Skb	19	13,5	1,0			1H.3.6.8.13.24	

Fdo

TYPE 1

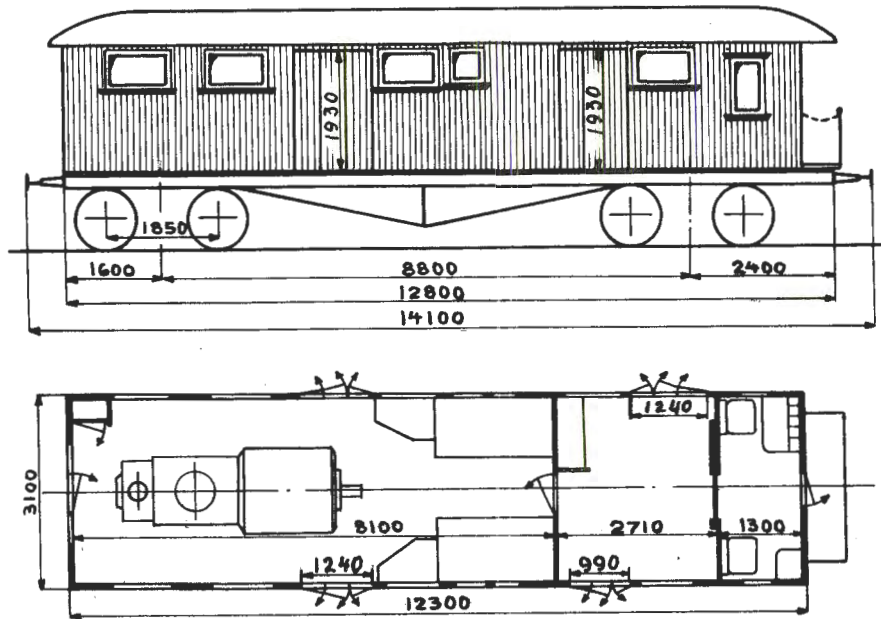

Hovedt. 2554

Vogn nr.	Distriktsmerke	Fabrikant	Byggeår	Omtr. vognvekt i tonn	Reisegods, last i tonn	Grunnriss	El.varme i kW	Vognutstyr (se side 6)	Merknad
20058	D	Str	22		2,0			1H.3.6.8.13	
20059	"	"	"	24,0	"			1H.3.6.8.13	
20060	"	"	"	20,0	"			1H.3.6.8.13	
20061	"	"	"	24,0	"			1H.3.6.8.13	

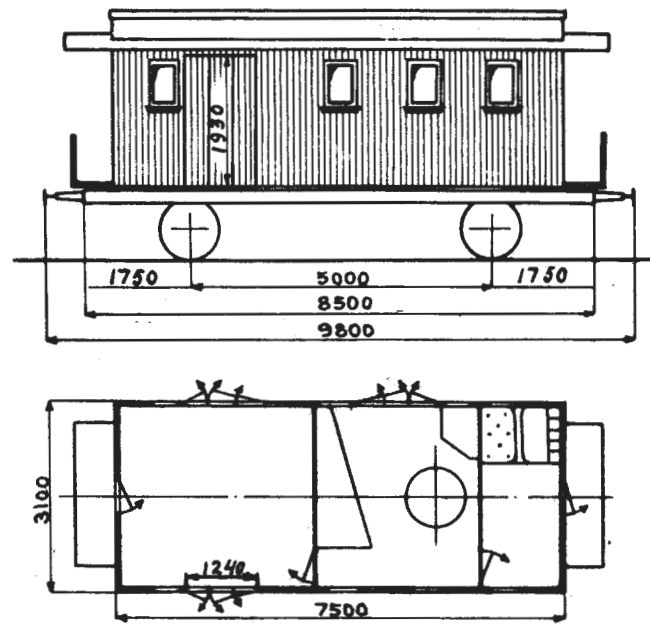

Hovedt. 2104

Vogn nr.	Distriktsmerke	Fabrikant	Byggeår	Omr. vognvekt i tonn	Reisegods, last i tonn	Grunnriss	El. varme i kW	Vognutstyr (se side 6)	Merknad
17952	T	Skb	19	13,5	1,0			1H.3.6.8.13.24	

Fdo

TYPE 1

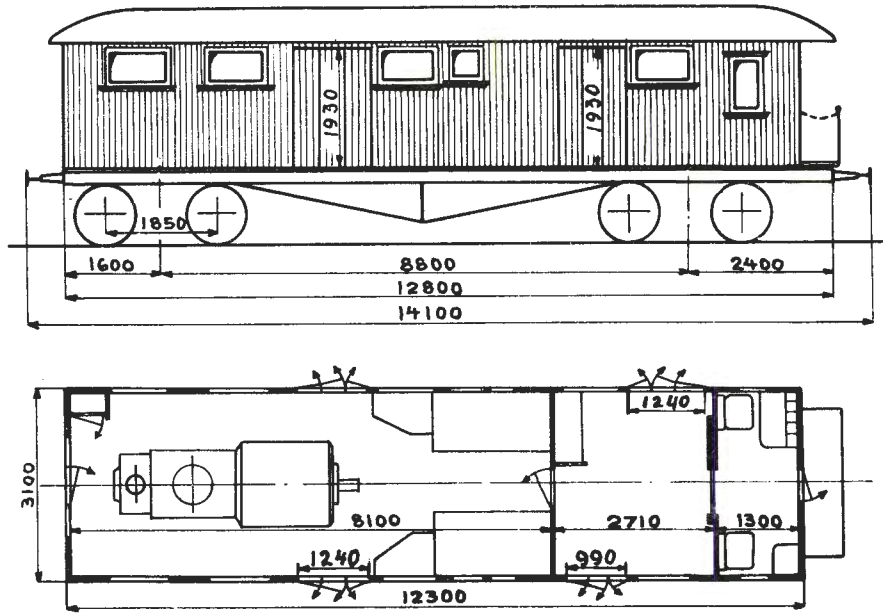

Hovedt. 2554

Vogn nr	Distriktsmerke	Fabrikant	Byggeår	Omtr. vognvekt i tonn	Reisegods, last i tonn	Grunnriss	El. varme i kW	Vognutstyr (se side 6)	Merknad
20058	D	Str	22	23,0	2,0			1H.3.6.8.13	1)
20059	"	"	"	24,0	"			1H.3.6.8.13	
20060	"	"	"	24,5	"			1H.3.6.8.13	1)
20061	"	"	"	24,0	"			1H.3.6.8.13	

1) Konduktørrom etter tegn. 6061

Trykk nr. 751 1.7.57

Fdo

TYPE 2

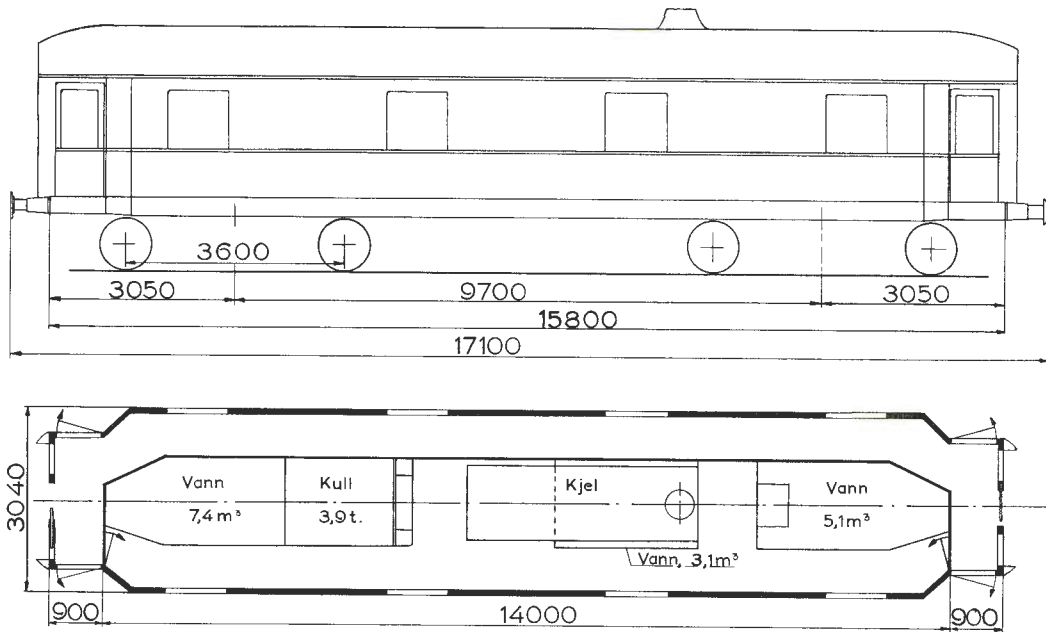

Hovedt. skisse 978

Vogn nr.	Distriktsmerke	Fabrikant	Byggeår	Omtr. vognvekt i tonn	Grunnriss	El. varme i kW	Vognutstyr (se side 6)	Merknad
19954			43	41,0			1KK. 3. 11 ¹ / ₂ 28.	Vognen er ennå ikke omnr. men går med sitt oppr. nr: 716012
19955			"	42,5			1KK. 3. 11 ¹ / ₂ 28.	

¹ Dampdreven generator

FZo

TYPE 1

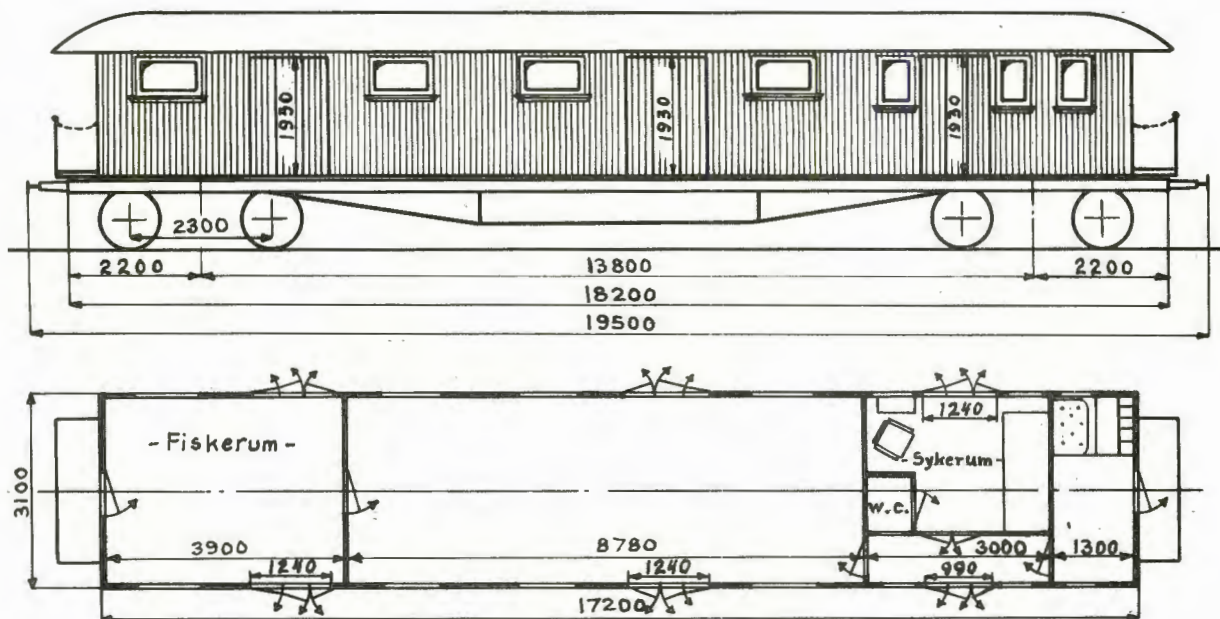

Oppr. hovedt. 2463¹⁾
2464¹⁾

Vogn nr.	Distriktsmerke	Fabrikant	Byggeår	Omr. vognvekt i tonn	Reisegods, last i tonn	Grunnriss	El. varme i kW	Vognutstyr (se side 6)	Merknad
5018	H	Str	21	29,0	9,0			1H.3.5.11.39a	
5019	"	"	"	28,5	"			1H.3.5.11.39a	

1) Forandr. etter tegn. 4402
Trykk nr. 751 1.7.56

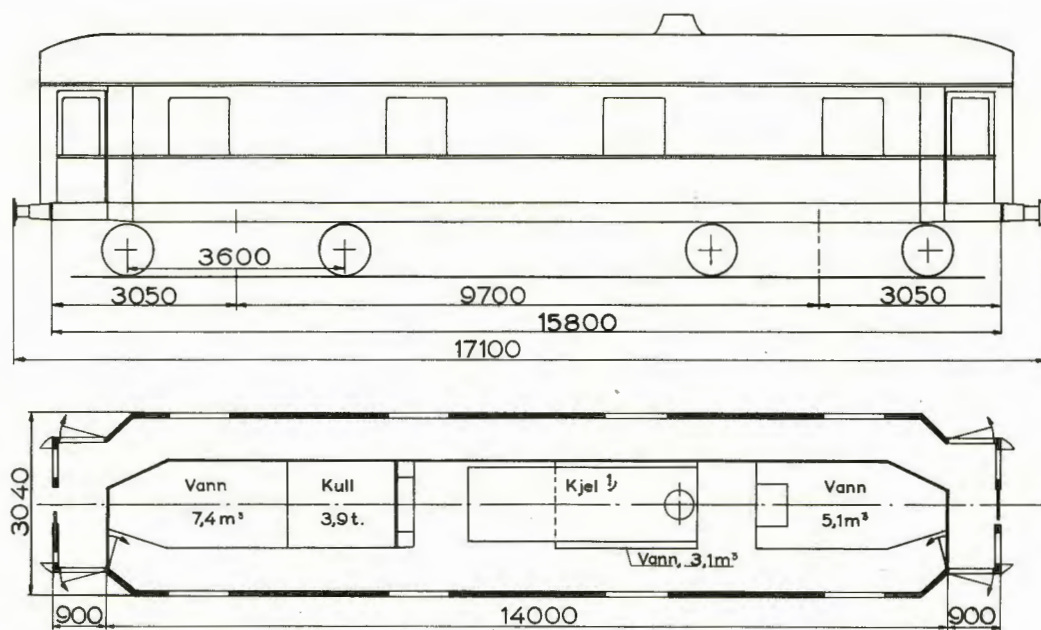

Hovedt. skisse 978

Vogn nr.	Distriktsmerke	Fabrikant	Byggeår	Omr. vognvekt i tonn	Grunnriss	El. varme i kW	Vognutstyr (se side 6)	Merknad
19954	O		43	430 ²⁾			1KK. 3. 11 ³⁾ . 28.	
19955	"		"	42,5 ²⁾			1KK. 3. 11 ³⁾ . 28.	

- 1) Vann på kjelen; 1,2m³
 2) Eksklusive kull og vannforsyning
 3) Dampdreven generator

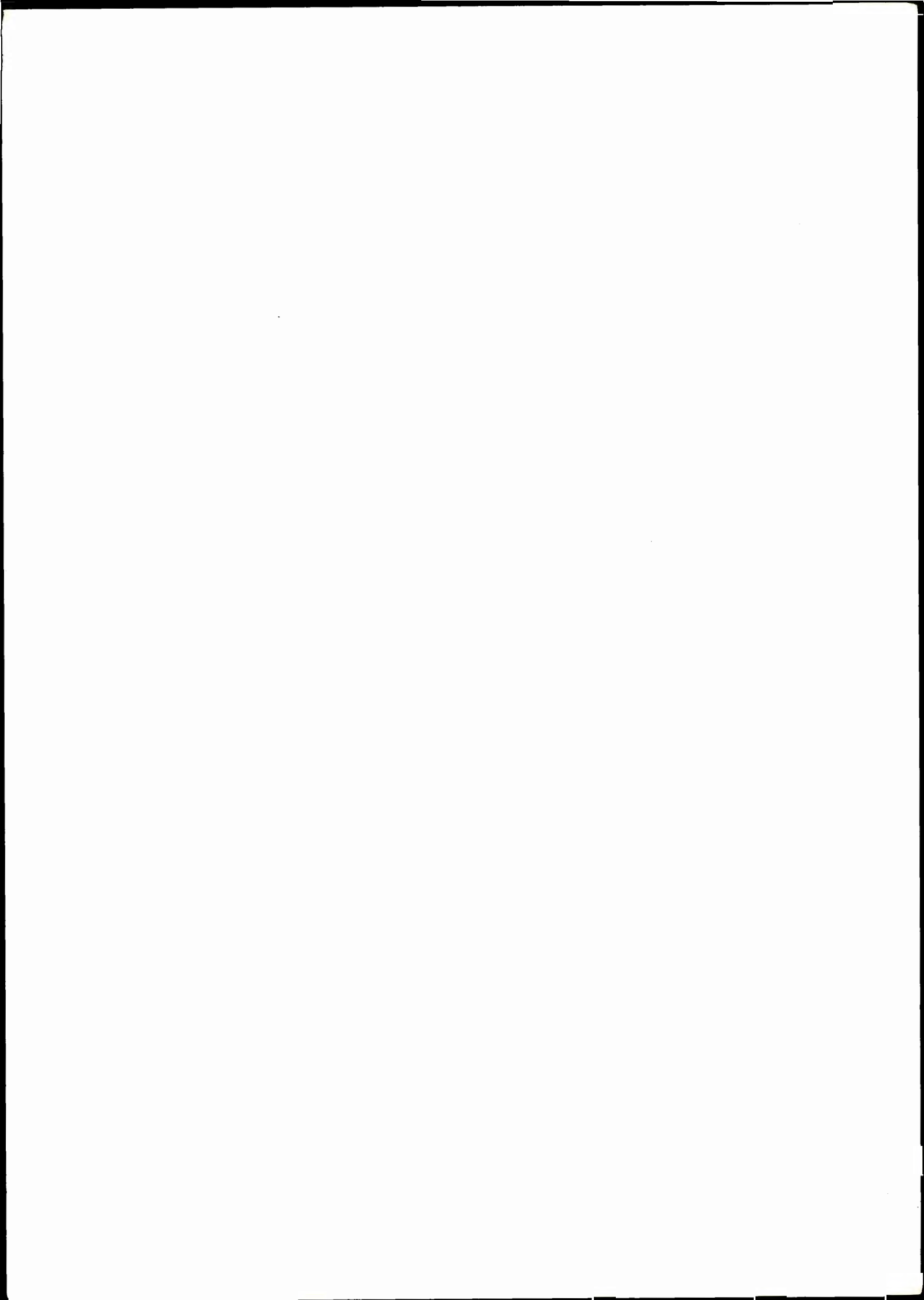

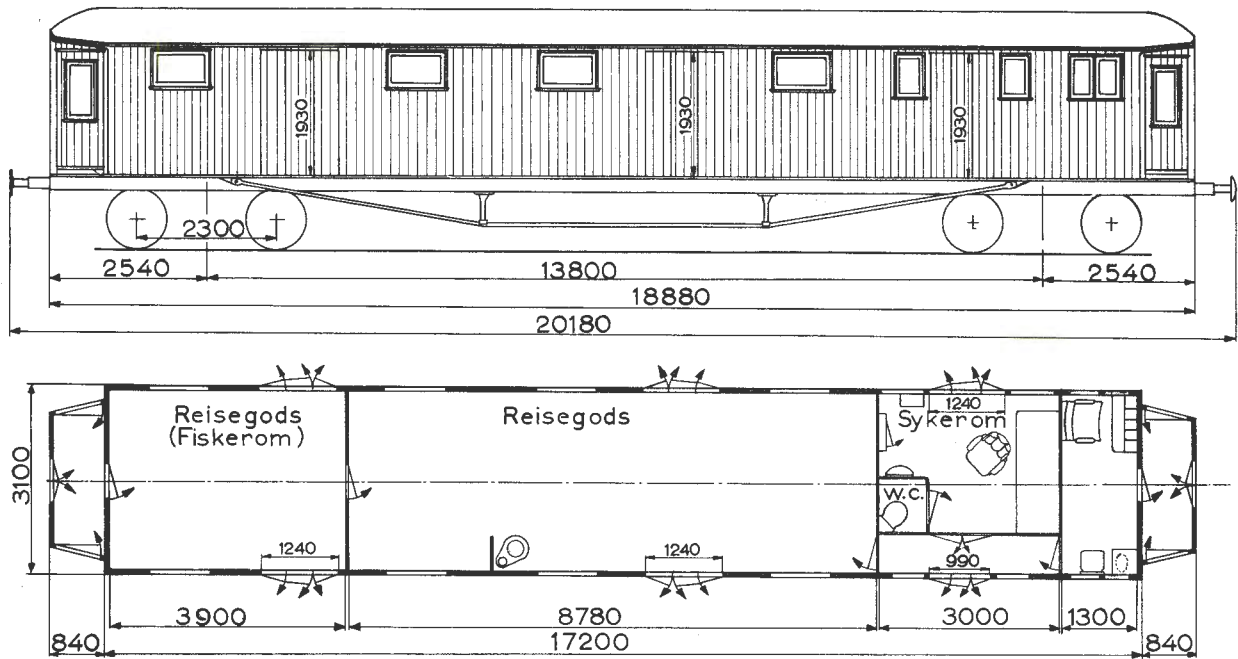

Oppr. hovedt. 2463^D

Vogn nr.	Distriktsmerke	Fabrikant	Byggeår	Omtr. vognvekt i tonn	Reisegods, last i tonn	Grunnriss	El. varme i kW	Vognutstyr (se side 6)	Merknad
5017	H	Str.	22	30,5	6,5			1H. 3. 5. 8. 11. 39a.	

^Dforandr. etter tegn. 4402

Zo

TYPE 1

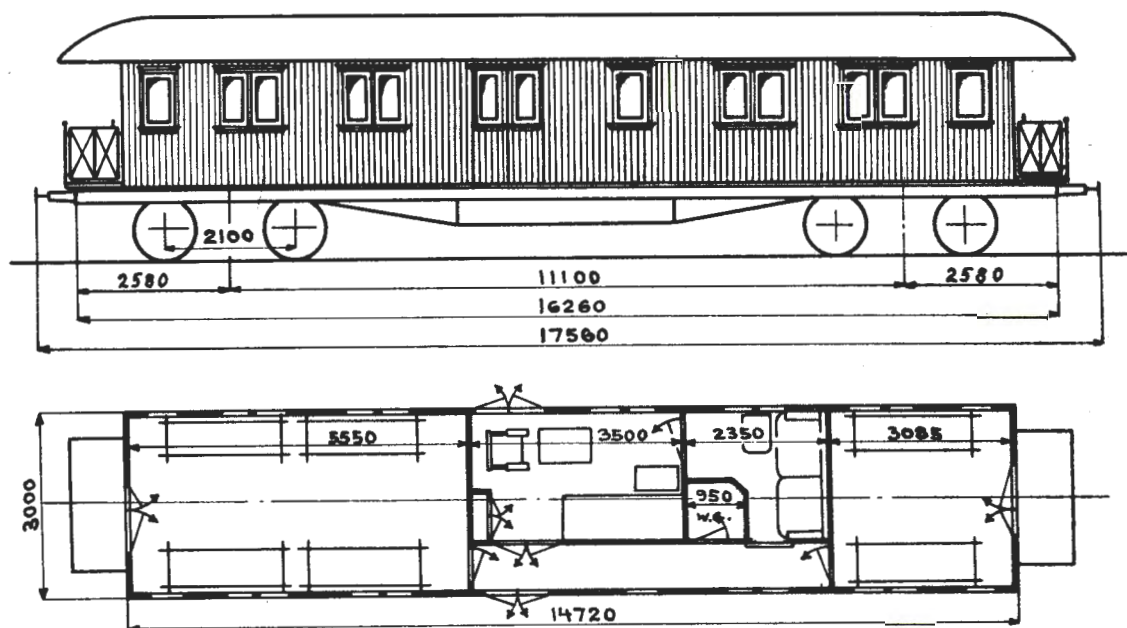

Oppr. hovedt. B. 87

Vogn nr.	Distriktsmerke	Fabrikant	Byggeår	Omtr. vognvekt i tonn	Reisegods, last i tonn	El-varme i kW	Vognutstyr (se side 6)	Merknad
16	0	Str	99	25,0			3.5.11.15.39a	

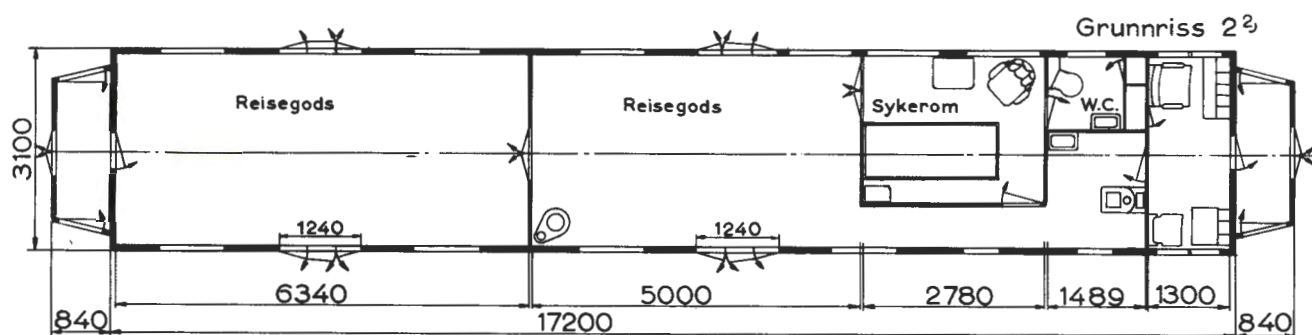
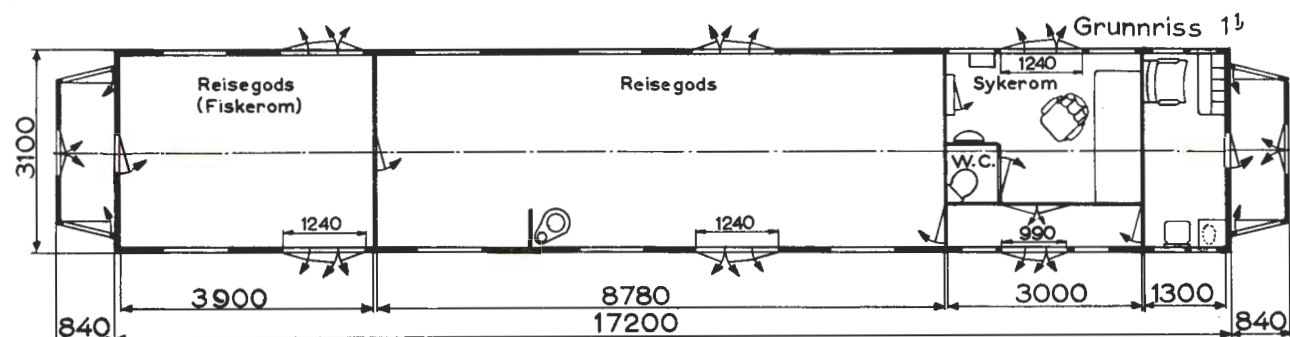
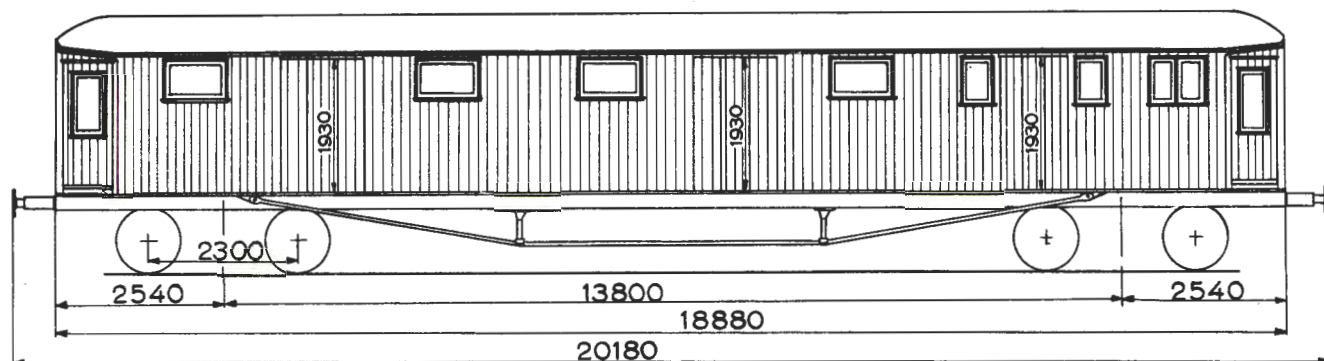

Oppr. hovedt. 2463

Vogn nr.	Distriktsmerke	Fabrikant	Byggeår	Omtr. vognvekt i tonn	Reisegods, last i tonn	Grunnriss	El. varme i kW	Vognutstyr (se side 6)	Merknad
5017	B	Str.	22	30,5	6,5	1		1H. 3. 5. 8. 11. 28. 39a	
5018	"	"	21	29,0	"	"		1H. 3. 5. 8. 11. 28. 39a	
5019	"	"	"	31,0	"	"		1H. 3. 5. 8. 11. 28. 39a	
5680	T	"	22	"	8,0	2		1H. 3. 5. 8. 11. 28. 40	
5681	"	"	"	30,5	"	"		1H. 3. 5. 8. 11. 28. 40	
17956	"	"	"	31,0	"	"		1H. 3. 5. 8. 11. 28. 40	

¹ Forandr. etter tegn. 4402

² ——— ——— ——— Td.M. 9249

Zo

TYPE 1

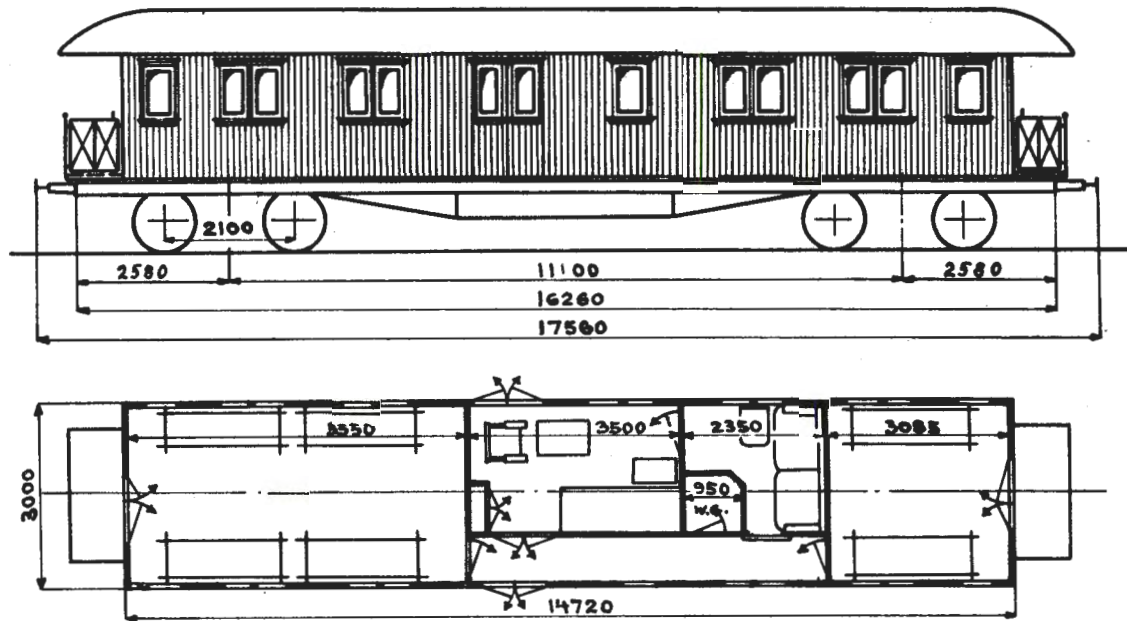

Oppr. hovedt. B. 87

Vogn nr:	Distriktmerke	Fabrikant	Byggear	Omtr: vognvekt i tonn	Reisegods, last i tonn	El-varme i kW	Vognutstyr (se side 6)	Merknad
15	0	Str	99	25,0			3.5.11.15.39a	

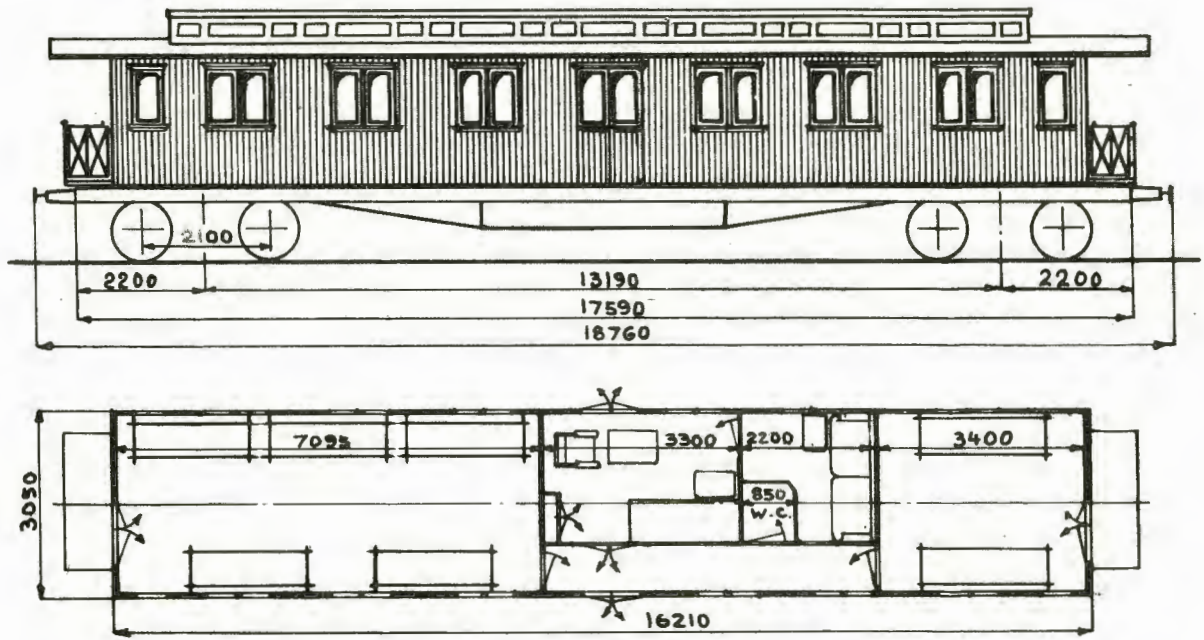

Oppr. hovedt. 468

Vogn nr.	Distriktsmerke	Fabrikant	Byggeår	Omt. vognvekt i tonn	Grunnriss	El. varme i kW	Vognutstyr (se side 6)	Merknad
126	D	Skb	00				1H.3.5.11.39a	

Zu

TYPE 1

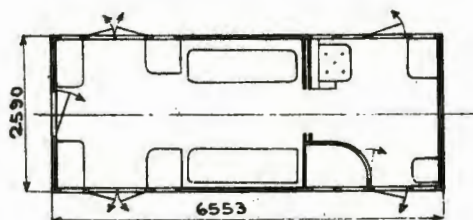
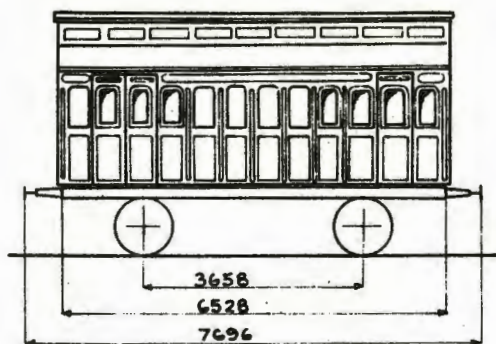

Vogn nr.	Distriktsmerke	Fabrikant	Byggeår	Omr. vognvekt i tonn	Grunnriss	El-varme i kW	Vognutstyr (se side 6)	Merknad
443	H	At1	79				3.6.7.13.34 ¹⁾	
520	D	Skb	"	11,0			3.6.7.12.15.34 ¹⁾ .39a	
527	"	"	"	10,5			3.6.7.12.13.15.39a	

1) Bare i vognens ene ende
Trykk nr. 751 1.7.57

Zo

TYPE 1

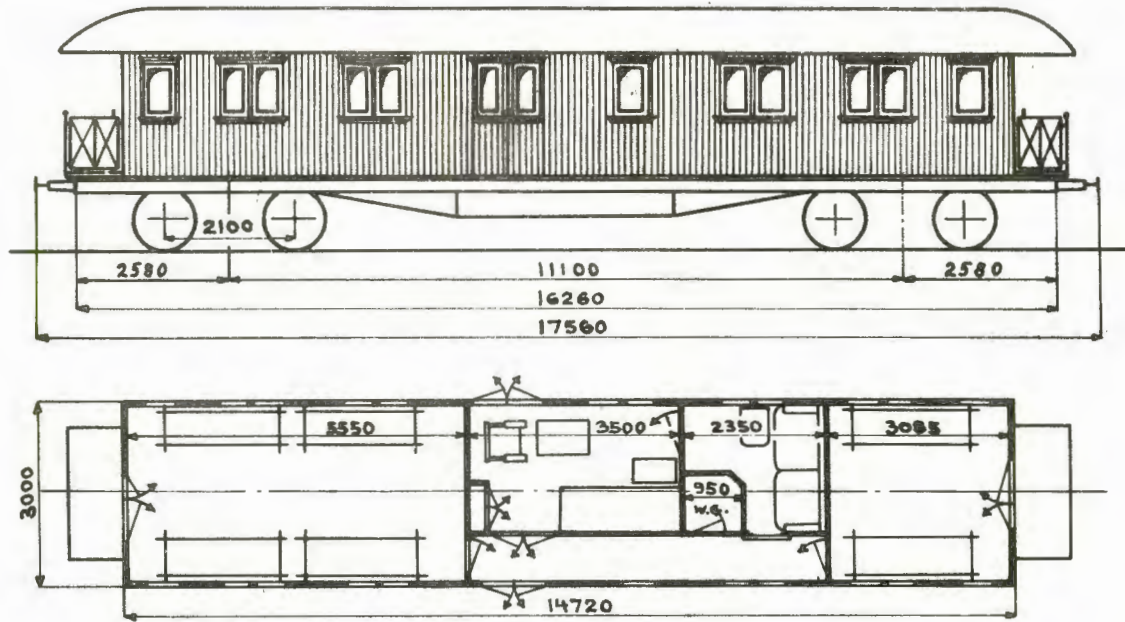

Oppr. hovedt. B. 87

Vogn nr.	Distriktsmerke	Fabrikant	Byggeår	Omr. vognvekt i tonn	Reisegods, last i tonn	Elvarme i kW	Vognutstyr (se side 6)	Merknad
16	0	Str	99	25,0			3.5.11.15.39a	

Byggetid i tiden 1.7.59 - 30.6.60:

Zuo

TYPE 1

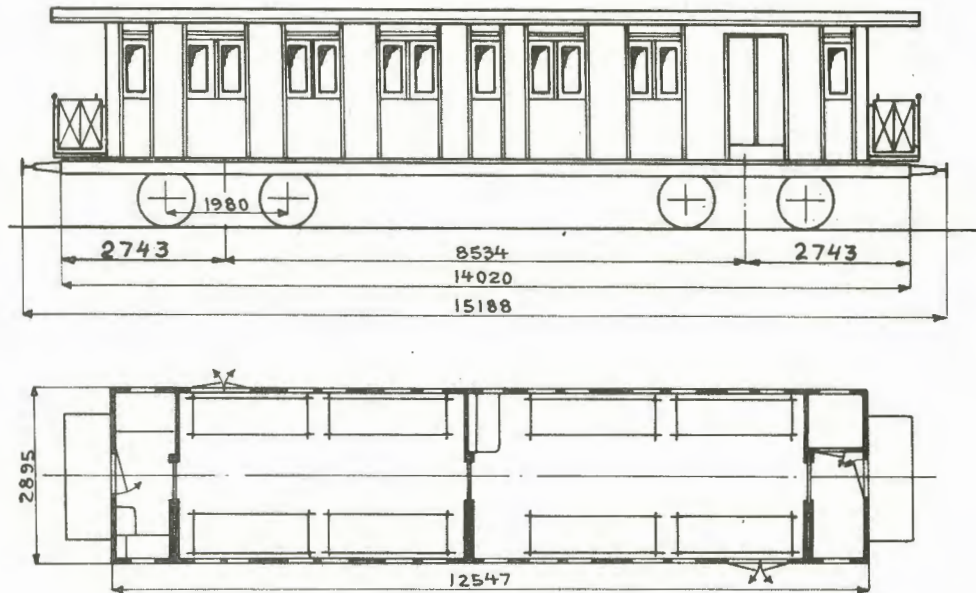

Oppr. hovedt. 24¹⁾

Vogn nr:	Distriktsmerke	Fabrikant	Byggeår	Omr. vognvekt i tonn	Grunnriss	El. varme i kW	Vognutstyr (se side 6)	Merknad
314	0	Skb	87	21,5			3.5.10.15	

1) Forandr. etter Skabos tegn. Z. 93
Trykk nr. 751 1.7.56

Zuo

TYPE 2

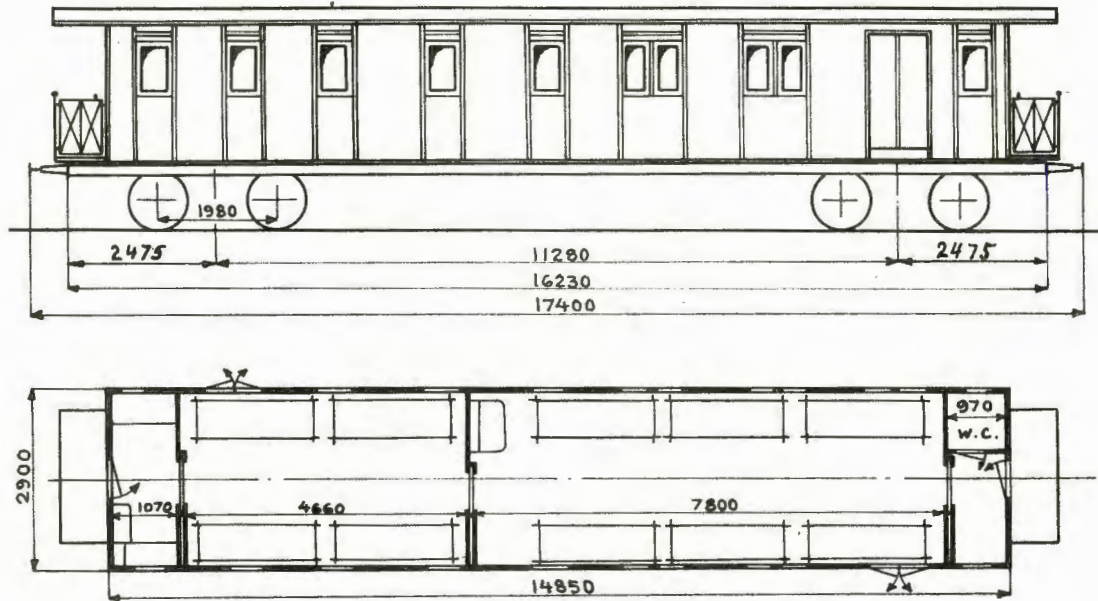

Oppr. hovedt. 205¹⁾

Vogn nr.	Distriktsmerke	Fabrikant	Byggeår	Omtr. vognvekt i tonn	Grunnriss	El.varme i kW	Vognutstyr (se side 6)	Merknad
132	B	At1	93	23,5			1H.3.5.10.39a	

1) Forandr. etter Skabos tegn. Z. 123
Trykk nr. 751 1.7.56

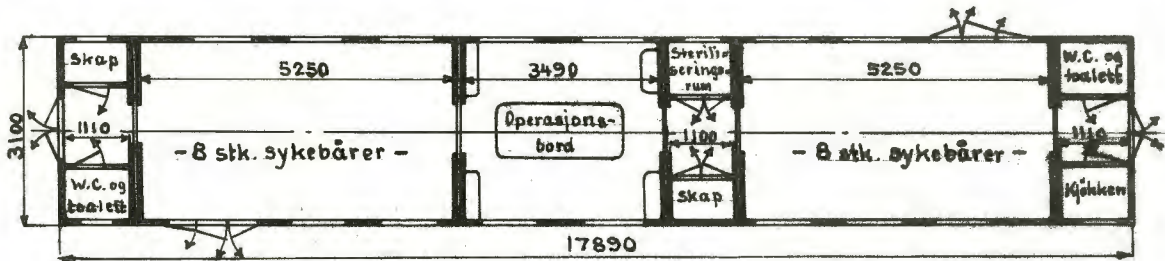
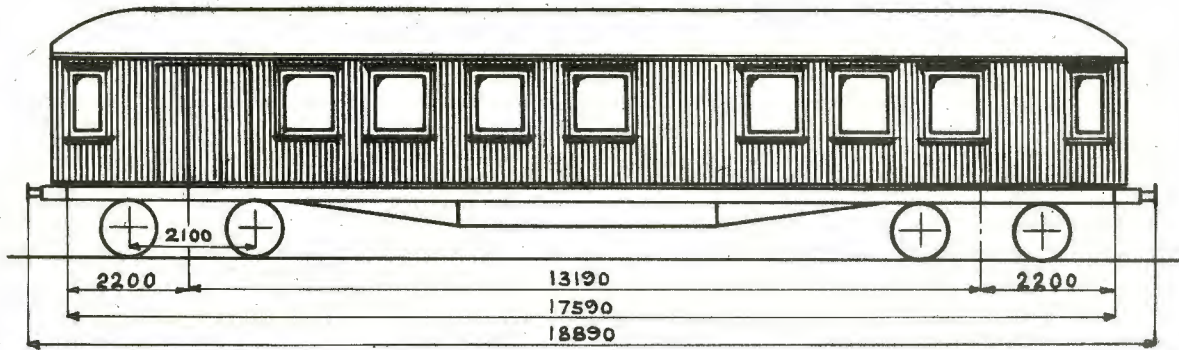

Hovedt. se merknad

Vogn nr:	Distriktsmerke	Fabrikant	Byggeår	Omr: vognvekt i tonn	Grunnriss	El.varme i kW	Vognutstyr (se side 6)	Merknad
205	D	Str	00				3.5.10.15.39a	Oppr. hovedt. 479
836	T	"	"	28,0			1H.3.5.10	} Oppr. hovedt. 439
166	O	"	01	24,5			1H.3.5.10.39a	
428	B	"	04	27,5			1KK.3.5.10.39a	Oppr. hovedt. 764
777	K	Skb	"	27,0			1H.3.5.10.39a	Oppr. hovedt. 745
954	H	Str	"				1H.3.5.10.39a	Oppr. hovedt. 699

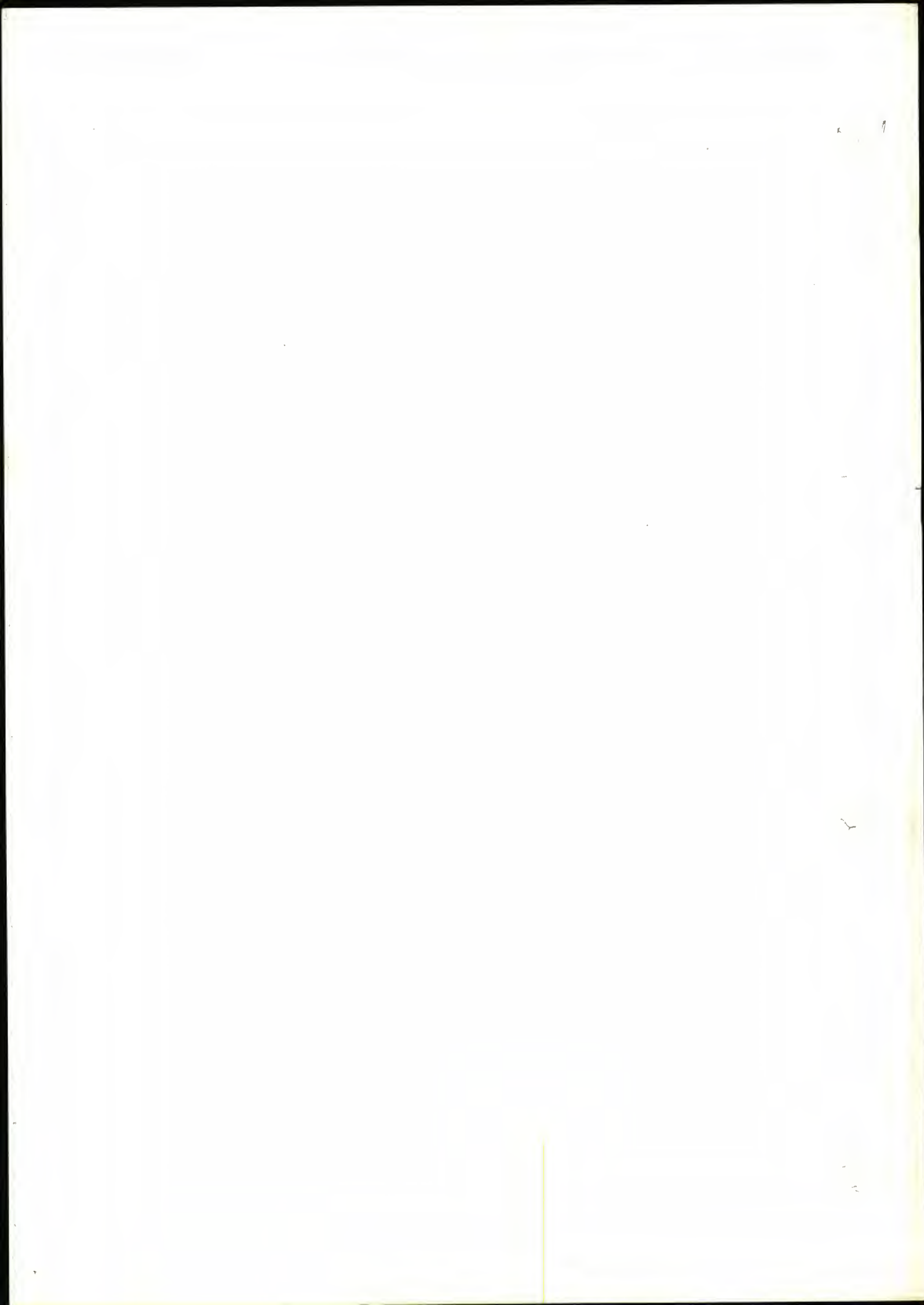

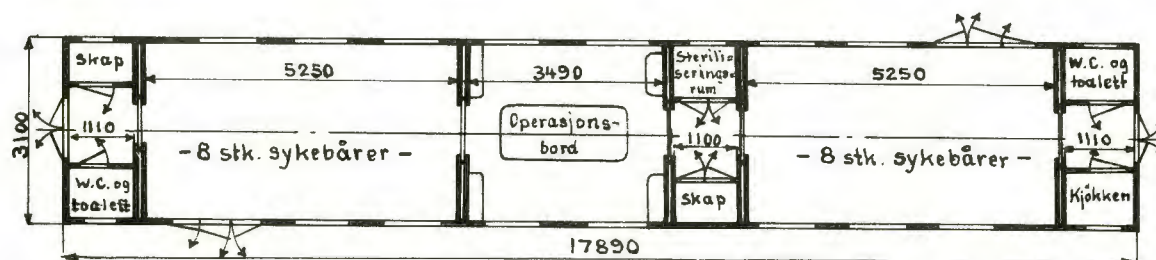
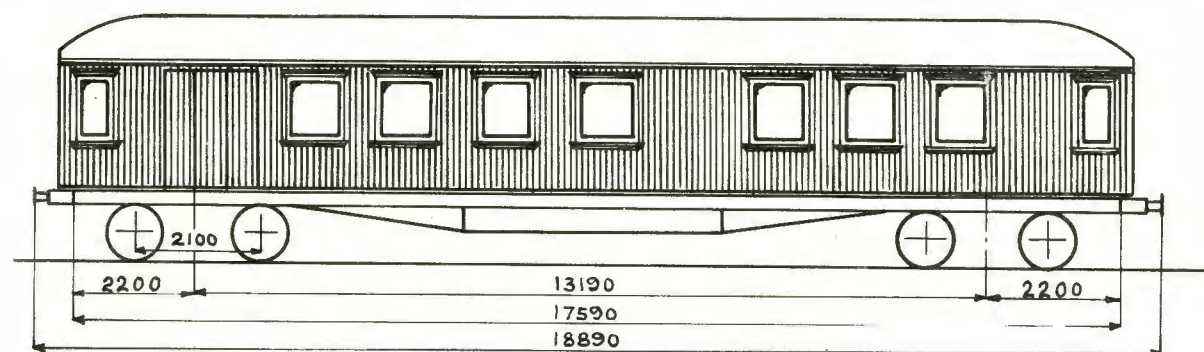

Hovedt. se merknad

Vogn nr.	Distriktsmerke	Fabrikant	Byggeår	Omr. vognvekt i tonn	Grunnriss	El. varme i kW	Vognutstyr (se side 6)	Merknad
166	O	Str	01	24,5			1H.3.5.10.39a	1)
205	D	"	00				3.5.10.15.39a	2)
428	B	"	04	27,5			1KK.3.5.10.39a	5)
777	K	Skb	"	27,0			1H.3.5.10.39a	4)
836	T	Str	00	28,0			1H.3.5.10.39a	1)
954	H	"	04				1H.3.5.10.39a	3)

- 1) Oppr. hovedt. 439
 2) " " 479
 3) " " 699
 4) " " 745
 5) " " 764

